



Metris

Operating Instructions



4475842503

Order no. 6463 7357 13 Part no. 447 584 25 03 Edition 03-17

Metris

Mercedes-Benz



Symbols

WARNING

Warning notes make you aware of dangers which could pose a threat to your health or life, or to the health and life of others.

Environmental note

Environmental notes provide you with information on environmentally aware actions or disposal.

 Notes on material damage alert you to dangers that could lead to damage to your vehicle.

 These symbols indicate useful instructions or further information that could be helpful to you.

 This symbol designates an instruction you must follow.

 Several consecutive symbols indicate an instruction with several steps.

 (▷ page) This symbol tells you where you can find further information on a topic.

 ▷ ▷ This symbol indicates a warning or an instruction that is continued on the next page.

Display This text indicates a message on the display.

Registered trademarks

ESP® is a registered trademark of Daimler AG.

Vehicle distributor

Mercedes-Benz USA, LLC
3 Mercedes Drive
Montvale, NJ 07645-0350
www.mbusa.com
Customer Assistance Center:
1-877-762-8267

Mercedes-Benz Canada, Inc.
98 Vanderhoof Avenue
Toronto, ON M4G 4C9
www.mercedes-benz.ca
Customer Relations Department:
1-800-387-0100

Mercedes-Benz USA, LLC and Mercedes-Benz Canada Inc. are Daimler companies.

Publication details

Internet

Further information about Mercedes-Benz vehicles and about Daimler AG can be found on the following websites:

<http://www.mercedes-benz.com>

<http://www.mbusa.com> (USA only)

<http://www.mercedes-benz.ca> (Canada only)

Editorial office

For USA and Canada:

You are welcome to forward any queries or suggestions you may have regarding these Operating Instructions to the technical documentation team at the address on the inside of the front cover.

© Mercedes-Benz USA, LLC

© Mercedes-Benz Canada, Inc.

Mercedes-Benz USA, LLC and Mercedes-Benz Canada Inc. are Daimler companies.

Not to be reprinted, translated, or otherwise reproduced, in whole or in part, without written permission.

Vehicle manufacturer

Daimler AG
Mercedesstraße 137
70327 Stuttgart
Germany

Welcome to the world of Mercedes-Benz

Before you first drive off, read the Operating Instructions carefully and familiarize yourself with your vehicle. Please adhere to the information and warning notes in this Operating Instructions for your own safety and to ensure a longer operating duration of the vehicle. Failure to observe the instructions may lead to damage to the vehicle or personal injury.

Vehicle damage caused by a failure to observe the instructions is not covered by the New Vehicle Limited Warranty.

The equipment or model designation of your vehicle may differ according to:

- Model
- Order
- Country specification
- Availability

The illustrations in this Operating Instructions show a left-hand-drive vehicle. The location of vehicle parts and controls for right-hand drive vehicles differ accordingly.

Mercedes-Benz is constantly updating its vehicles to the state of the art.

Mercedes-Benz reserves the right to introduce changes in:

- Design
- Equipment
- Technology

Therefore, the descriptions provided may occasionally differ from your own vehicle.

The following are integral parts of the vehicle:

- Operating Instructions
- Maintenance or Service Booklet
- Equipment-dependent operating instructions

Keep these printed documents in the vehicle at all times. Should you sell the vehicle, always pass the documents on to the new owner.

Index 4**Introduction 27**

Operating Instructions 27

Service and vehicle operation 27

Proper use 29

Protection of the environment 29

Operating safety and vehicle approval
..... 30

Genuine Mercedes-Benz parts 33

QR code for rescue card 34

Data stored in the vehicle 34

At a glance 36

Cockpit 36

Instrument cluster (vehicles without
steering wheel buttons) 37Instrument cluster (vehicles with
steering wheel buttons) 39

Steering wheel buttons 41

Center console 42

Overhead control panel 43

Door control panel 43

Safety 45

Useful information 45

Occupant safety 45

Children in the vehicle 58

Pets in the vehicle 64

Driving safety systems 64

Theft deterrent locking system 67

Opening and closing 69

Useful information 69

Key 69

Central locking 73

Driver's door and front-passenger
door 74

Sliding door 74

Electric sliding door 75

Tailgate 78

Rear doors 79

Side windows 81

Seats, steering wheel and mirrors 84

Useful information 84

Seats 84

Steering wheel 91

Mirrors 91

Lights and windshield wipers 94

Useful information 94

Exterior lighting 94

Interior lighting 97

Replacing bulbs: interior lighting and
ambient lamps 98

Replacing bulbs 100

Windshield wipers 104

Climate control 108

Useful information 108

Overview of climate control systems ... 108

Operating the climate control system .. 111

Adjusting the air vents 118

Driving and parking 120

Useful information 120

Breaking-in notes 120

Driving 120

Automatic transmission 126

Refueling 132

Parking 133

Driving tips 135

Driving systems 142

Towing a trailer 163

On-board computer and displays 169

Useful information 169

Important safety notes 169

Display and operation 169

On-board computer (vehicles without
steering wheel buttons) 171On-board computer (vehicles with
steering wheel buttons) 176Display messages (vehicles without
steering wheel buttons) 189Display messages (vehicles with
steering wheel buttons) 203

Indicator and warning lamps in the instrument cluster	219	Important safety notes	277
Multimedia systems in brief	230	Operation	277
Introduction	230	Operation in winter	279
Audio 15	232	Tire pressure	280
Stowing and features	238	Loading the vehicle	288
Useful information	238	What you should know about wheels and tires	291
Stowage spaces and stowage compartments	238	Changing wheels	296
Sun visors	239	Wheel and tire combination	300
Cup holder	239	Spare wheel	301
Bottle holder	240	Technical data	303
Ashtray	240	Useful information	303
Cigarette lighter	240	Vehicle electronics	303
12 V socket	241	Identification plates	303
Mobile communications equipment	241	Service products and capacities	304
Transporting loads	242	Vehicle data	311
Useful information	242		
Loading guidelines	242		
Load distribution	243		
Securing loads	244		
Lashing straps	245		
Securing loads	247		
Carrier systems	248		
Maintenance and care	250		
Useful information	250		
Engine compartment	250		
Maintenance	257		
Battery	258		
Care	263		
Breakdown assistance	270		
Useful information	270		
Where will I find...?	270		
Flat tire	272		
Jump-starting	272		
Tow-starting and towing away	274		
Electrical fuses	276		
Wheels and tires	277		
Useful information	277		

1, 2, 3 ...**12 V socket** 241**A****ABS (anti-lock braking system)**

Display message (vehicle with steering wheel buttons) 204

Display message (vehicle without steering wheel buttons) 190

Function/notes 64

Important safety notes 64

Warning lamp 222

Acceleration

see Kickdown

Accident

Automatic measures after an accident 58

Activating/deactivating cooling**with air dehumidification** 112**Active Parking Assist**

Canceling/stopping active parking assistance 158

Detecting parking spaces 155

Display message 214

Exiting a parking space 157

Function/notes 154

Important safety notes 154

Parking 156

Towing a trailer 154

Add-on equipment 32**Additional indicators**

Replacing bulbs 102

Additional speedometer

On-board computer (vehicle with steering wheel buttons) 186

On-board computer (vehicle without steering wheel buttons) 175

Additives

Engine oil 308

Gasoline 306

Air bag

Display message (vehicle with steering wheel buttons) 205

Display message (vehicle without steering wheel buttons) 191

Air bags

Deployment 56

Front air bag (driver, front passenger) 51

Important safety notes 50

Introduction 49

Occupant Classification System (OCS) 52

PASSENGER AIR BAG OFF indicator lamp 46

Side impact air bag 51

Window curtain air bag 52

Air pressure

see Tire pressure

Air vents

Important safety notes 118

Setting the center air vents 118

Setting the rear-compartment air vents 118

Setting the side air vents 118

Air vents

see Air vents

Air-conditioning system

see Climate control

Alarm system

see ATA (Anti-Theft Alarm system)

Alertness assistant

see ATTENTION ASSIST

Ambient lamp

Changing a bulb (front door) 99

Changing a bulb (tailgate) 99

Changing a bulb (vanity mirror) 99

Anti-lock braking system

see ABS (Anti-lock Braking System)

Anti-skid chains

see Snow chains

Anti-Theft Alarm system

see ATA (Anti-Theft Alarm system)

Armrests 90**Ashtray** 240**ATA (Anti-Theft Alarm system)** 68**ATTENTION ASSIST**

Activating/deactivating (vehicle with steering wheel buttons) 185

Activating/deactivating (vehicle without steering wheel buttons) 175

Display messages (vehicle with steering wheel buttons) 214

- Display messages (vehicle with-
out steering wheel buttons) 200
 - Function/notes 150
 - ATTENTION ASSIST**
see ATTENTION ASSIST
 - Audio 10**
Important safety notes 230
 - Audio 15**
Bluetooth® settings 234
 - Display overview 233
 - Entering the passkey 234
 - Important safety notes 230
 - Making a call 236
 - Media mode 235
 - Navigation 236
 - Overview 232
 - Telephone mode 236
 - Authorized workshop**
see Qualified specialist workshop
 - AUTO lamp**
Display messages (vehicle with-
out steering wheel buttons) 196
 - AUTO lights**
Display messages (vehicle with
steering wheel buttons) 210
 - see Lights
 - Automatic car wash (care)** 264
 - Automatic engine start (ECO start/
stop function)** 124
 - Automatic engine switch-off (ECO
start/stop function)** 124
 - Automatic headlamp mode** 95
 - Automatic locking** 74
 - Automatic transmission**
Accelerator pedal position 130
 - Changing gear 128
 - DIRECT SELECT lever 126
 - Display message 218
 - Drive program display 128
 - Driving tips 130
 - Emergency running mode 132
 - Engaging drive position 127
 - Engaging neutral 127
 - Engaging reverse gear 127
 - Engaging the park position 127
 - Gearshift recommendation 131
 - Important safety notes 126
 - Kickdown 130
 - Manual shifting 130
 - Overview 126
 - Problem (malfunction) 132
 - Program selector button 129
 - Rocking the vehicle free 130
 - Shift ranges 128
 - Starting the engine 122
 - Steering wheel paddle shifters 130
 - Trailer towing 130
 - Transmission oil change 308
 - Transmission position display
(DIRECT SELECT lever) 128
 - Transmission positions 127
 - Automatic transmission emer-
gency mode** 132
 - Axle load, permissible (trailer tow-
ing)** 314
- ## B
- Backup lamp**
Display messages (vehicle with
steering wheel buttons) 211
 - Backup lamps**
Display messages (vehicle with-
out steering wheel buttons) 197
 - Replacing bulbs 103
 - BAS (Brake Assist System)**
Function/notes 65
 - Basic settings**
see Settings
 - Battery (SmartKey)**
Checking 71
 - Important safety notes 71
 - Replacing 72
 - Battery (vehicle)**
Care 263
 - Charging 262
 - Connecting and installing 261
 - Disconnecting and removing 259
 - Display messages (vehicle with
steering wheel buttons) 212
 - Display messages (vehicle with-
out steering wheel buttons) 198
 - Important safety notes 258
 - Jump starting 272
 - Location 259

- Before driving off**
 Important safety notes 121
- Belt**
 see Seat belts
- Belt warning** 49
- Blind Spot Assist**
 Activating 148
 Activating/deactivating (vehicle with steering wheel buttons) 185
 Collision warning 148
 Display message 216
 Important safety notes 146
 Monitoring range of the sensors 147
 Notes/function 146
 Trailer towing 148
 Warning display 148
- Blower**
 see Climate control
- Bluetooth® Audio** 182
- Brake**
 Display message (vehicle without steering wheel buttons) 190
- Brake Assist**
 see BAS (Brake Assist System)
- Brake assistance**
 see BAS (Brake Assist System)
- Brake fluid**
 Checking the level 255
 Display message (vehicle with steering wheel buttons) 207
 Display message (vehicle without steering wheel buttons) 193
 Notes 309
- Brake force distribution**
 see EBD (electronic brake force distribution)
- Brake lamps**
 Display messages (vehicle with steering wheel buttons) 210
 Display messages (vehicle without steering wheel buttons) 196
 Replacing bulbs 103
 Trailer display messages (vehicle with steering wheel buttons) 210
 Trailer display messages (vehicle without steering wheel buttons) 196
- Brake pads/linings**
 New 138
- Brakes**
 ABS 64
 Adaptive Brake Assist 145
 Applying the parking brake 134
 BAS 65
 Brake fluid (notes) 309
 Checking brake fluid level 255
 Display message (vehicle with steering wheel buttons) 204
 EBD 65
 Hill start assist 123
 Important safety notes 137
 New brake pads/linings 138
 Parking brake (notes) 138
 Riding tips 137
 Warning lamp 221
- Breakdown**
 Vehicle tool kit 270
 see Towing away
- Buttons**
 On the instrument cluster 171
 On the steering wheel 176
- C**
- California**
 Important notice for retail customers and lessees 27
- Camera**
 see Rear view camera
- Car**
 see Vehicle
- Car key**
 see SmartKey
- Car wash**
 see Care
- Care**
 Car wash 264
 Carpets 269
 Display 268
 Exterior lights 266
 Interior 267
 Notes 263
 Paint 265
 Plastic trim 268
 Power washer 264
 Rear view camera 267
 Roof lining 269

- Seat belt 269
- Seat cover 268
- Sensors 266
- Sliding door 267
- Steering wheel 268
- Trim pieces 268
- Washing by hand 264
- Washing the engine 265
- Wheels 266
- Windows 265
- Wiper blades 266
- Cargo compartment**
- Options 244
- Seating 86
- Cargo compartment lamp**
- Changing bulbs 99
- Cargo compartment lighting**
- Switching on centrally 98
- Switching on locally 98
- Cargo tie-down rings**
- Permissible tensile load 312
- Center console**
- Controls 42
- Central locking**
- Activating/deactivating the acoustic locking confirmation (on-board computer) 188
- Automatic locking 74
- Automatic locking (on-board computer) 188
- Emergency unlocking 70
- Locking/unlocking (buttons) 73
- Locking/unlocking (SmartKey) 69
- Central locking system**
- see Central locking
- Change of address** 28
- Change of ownership** 28
- Changing a bulb**
- Ambient lamp in the front door 99
- Halogen headlamps 100
- Mirror lamp in the headliner 99
- Signal and ambient light in the tailgate 100
- Trunk lamp in the side trim panel 99
- Changing bulbs**
- Additional turn signals 102
- Ambient lamp in tailgate 99
- Backup lamps 103
- Brake lamps 103
- Cargo compartment lamp 99
- Daytime running lamps 102
- High-beam headlamps 102
- Installing/removing a rear lamp cluster 103
- Installing/removing the cover in the wheel arch 101
- Installing/removing the tail lamp ... 103
- Interior light 98
- Interior lighting 98
- Low-beam headlamps 101
- Overview of lamp types (front bulbs) 101
- Overview of lamp types (rear bulbs) 102
- Parking lamps 102
- Rear fog lamp 103
- Rear interior light in the headliner ... 99
- Standing lamps (front) 102
- Standing lamps (rear) 103
- Tail lamps 103
- Trunk lamp in the headliner 98
- Turn signals (front) 102
- Turn signals (rear) 103
- see Changing light bulbs
- Changing bulbs**
- see Replacing bulbs
- Child**
- Restraint system 59
- Child seat**
- Forward-facing restraint system 62
- LATCH-type (ISOFIX) child seat anchors 61
- On the front-passenger seat 62
- Rearward-facing restraint system 62
- Top Tether 61
- Child-proof locks**
- Important safety notes 63
- Sliding door 63
- Children**
- Special seat belt retractor 59
- Children in the vehicle**
- Important safety notes 58
- Cigarette lighter** 240
- Cleaning**
- Trailer tow hitch 267

Cleaning

see Care

Climate control

- Air conditioning in the rear compartment 111
- Control panel for dual-zone automatic climate control 110
- Controlling automatically 113
- Cooling with air dehumidification .. 112
- Defrosting the windows 116
- Defrosting the windshield 115
- Important safety notes 108
- Information on dual-zone automatic climate control 110
- Information on TEMPMATIC (air-conditioning system) 109
- Overview of systems 108
- Problem with the rear window defroster 116
- Rear-compartment air conditioning 111
- Refrigerant 310
- Refrigerant filling capacity 310
- Setting the air distribution 114
- Setting the air vents 118
- Setting the airflow 114
- Setting the temperature 113
- Switching air-recirculation mode on/off 116
- Switching on/off 111
- Switching residual heat on/off 117
- Switching the rear window defroster on/off 116
- Switching the synchronization function on and off 115
- TEMPMATIC control panel (air conditioning) 109

Clock

- Setting (vehicle without steering wheel buttons) 176

Cockpit

- Instrument cluster (vehicle with steering wheel buttons) 39
- Instrument cluster (vehicle without steering wheel buttons) 37
- Overview 36
- see Instrument cluster

Coffee cup symbol

see ATTENTION ASSIST

COLLISION PREVENTION ASSIST

- Activating/deactivating the distance warning function 185
- Adaptive Brake Assist 145
- Display message 214
- Distance warning function 144
- Operation/notes 144

Collision warning

see COLLISION PREVENTION ASSIST

COMAND display

- Cleaning 268

Combination switch

- 96

Communications equipment

- Operation 241
- Type approval/frequency 303

Consumption statistics

- Fuel (vehicle with steering wheel buttons) 179
- Fuel (vehicle without steering wheel buttons) 172

Control panel

- Above the windshield 43
- Center console 42
- Climate control 42
- Driver's door 43

Convenience closing feature

- 83

Convenience opening

- With the SmartKey 117

Convenience opening feature

- 82

Conversions/equipment

- 32

Coolant (engine)

- Adding 255
- Checking the level 253
- Display messages (vehicle with steering wheel buttons) 213
- Display messages (vehicle without steering wheel buttons) 198
- Displaying the temperature (on-board computer) 173
- Filling capacity 310
- Notes 309
- Temperature display in the instrument cluster 170
- Warning lamp 225

Cooling

see Climate control

- Crosswind Assist** 67
- Cruise control**
- Activating 143
 - Activation conditions 143
 - Cruise control lever 142
 - Deactivating 143
 - Display messages (vehicle with steering wheel buttons) 215
 - Display messages (vehicle without steering wheel buttons) 200
 - Displaying the speed 142
 - Driving system 142
 - Function/notes 142
 - Important safety notes 142
 - Problem (malfunction) 144
 - Resuming the stored speed 143
 - Setting a speed 143
 - Storing and maintaining current speed 143
- Cup holder** 240
- Important safety notes 239
- Cup holder**
- see Cup holder
- Customer Assistance Center (CAC)** 32
- Customer Relations Department** 32
- D**
- Dashboard**
- see Cockpit
- Dashboard lighting**
- see Instrument cluster lighting
- Data**
- see Technical data
- Date**
- Setting (vehicle with steering wheel buttons) 187
 - Setting (vehicle without steering wheel buttons) 176
- Daytime running lamp mode**
- see Daytime running lamps
- Daytime running lamps**
- Changing bulbs 102
 - Display messages (vehicle with steering wheel buttons) 211
 - Display messages (vehicle without steering wheel buttons) 197
 - Switching on/off (switch) 95
- Dealership**
- see Qualified specialist workshop
- Declarations of conformity** 31
- Delayed switch-off**
- Exterior lighting (on-board computer) 187
 - Interior lighting 188
- Diagnostics connection**
- Operating safety and vehicle approval 31
- Digital speedometer**
- Displaying (vehicle with steering wheel buttons) 179
 - Displaying (vehicle without steering wheel buttons) 173
- Dimensions** 311
- DIRECT SELECT lever**
- Automatic transmission 126
- Display**
- Function/notes (vehicle with steering wheel buttons) 177
 - Function/notes (vehicle without steering wheel buttons) 171
 - Permanent display (vehicle with steering wheel buttons) 186
 - Permanent display (vehicle without steering wheel buttons) 175
 - see Warning and indicator lamps
- Display message (vehicle with steering wheel buttons)**
- Safety systems 204
 - Service interval display 257
- Display message (vehicle without steering wheel buttons)**
- Safety systems 190
 - Service interval display 257
- Display messages (vehicle with steering wheel buttons)**
- Calling up 203
 - Driving systems 214
 - Engine 212
 - Hiding 203
 - Important safety notes 203
 - Introduction 203
 - Key 219
 - Lights 209
 - Setting the language 186

- Tires 217
- Vehicle 218
- Display messages (vehicle without steering wheel buttons)**
- Calling up 189
- Driving systems 200
- Engine 198
- Hiding 189
- Important safety notes 189
- Introduction 189
- Key 203
- Lamps 196
- Setting the language 174
- Tires 201
- Vehicle 202
- Distance recorder**
- Displaying (vehicle with steering wheel buttons) 178
- Displaying (vehicle without steering wheel buttons) 172
- Setting the display unit (vehicle without steering wheel buttons) 175
- Distance recorder**
- see Trip odometer
- Distance warning (warning lamp) 227**
- Distance warning function 144**
- Door**
- Changing bulbs (ambient lamp) 99
- Display messages (vehicle with steering wheel buttons) 219
- Display messages (vehicle without steering wheel buttons) 202
- Indicator lamp 229
- Doors**
- Central locking/unlocking (SmartKey) 69
- Control panel 43
- Emergency locking 71
- Emergency unlocking 71
- Drinking and driving 136**
- Drinks holder**
- see Bottle holder
- Drive program**
- Automatic transmission 129
- Display (DIRECT SELECT lever) 128
- Driver's door and front-passenger door 74**
- Driving abroad**
- Fuel 137
- Low-beam headlamps 137
- Mercedes-Benz Service 137
- Driving off-road**
- see Off-road driving
- Driving on flooded roads 139**
- Driving safety systems**
- ABS (Anti-lock Braking System) 64
- BAS (Brake Assist System) 65
- EBD (electronic brake force distribution) 65
- ESP® (Electronic Stability Program) 65
- Important safety information 64
- Overview 64
- Driving system**
- COLLISION PREVENTION ASSIST .. 144
- Display messages (vehicle without steering wheel buttons) 200
- Driving systems**
- Active Parking Assist 154
- ATTENTION ASSIST 150
- Blind Spot Assist 146
- Cruise control 142
- Display messages (vehicle with steering wheel buttons) 214
- Lane Keeping Assist 148
- PARKTRONIC 151
- Rear view camera 158
- Driving tips**
- Automatic transmission 130
- Brakes 137
- Break-in period 120
- Checking brake lining thickness 138
- Downhill gradient 137
- Drinking and driving 136
- Driving abroad 137
- Driving in mountainous areas 141
- Driving in winter 139
- Driving on flooded roads 139
- Driving on wet roads 139
- Exhaust check 136
- Fuel 136
- General 135
- Hydroplaning 139
- Icy road surfaces 139
- Important safety notes 120

- Limited braking efficiency on salted roads 138
 - New brake disks 138
 - New brake pads/linings 138
 - Off-road driving 140
 - Overrun cut-off 136
 - Snow chains 280
 - Speed limitation 136
 - Towing a trailer 163
 - Wet road surface 138
- E**
- EBD (electronic brake force distribution)**
 - Display message (vehicle with steering wheel buttons) 207
 - Display message (vehicle without steering wheel buttons) 193
 - Function/notes 65
 - ECO start/stop function**
 - Automatic engine start 124
 - Automatic engine switch-off 124
 - Deactivating/activating 125
 - General information 123
 - Important safety notes 124
 - Electric sliding door**
 - Function 76
 - Important safety notes 75
 - Obstacle detection 76
 - Opening/closing from the inside 77
 - Problem (malfunction) 78
 - Programming the key button 78
 - Resetting 78
 - Reversing feature 76
 - Electrical fuses**
 - see Fuses
 - Electrical sliding door**
 - Opening/closing from the outside 76
 - Electronic brake force distribution**
 - see EBD (electronic brake force distribution)
 - Electronic Stability Program**
 - see ESP® (Electronic Stability Program)
 - Emergency**
 - Automatic measures after an accident 58
 - Emergency braking**
 - see BAS (Brake Assist System)
 - Emergency release**
 - Vehicle 71
 - Emergency Tensioning Devices**
 - Activation 56
 - Emissions control**
 - Service and warranty information 27
 - Engine**
 - Altitude limit (diesel engine) 141
 - Changing the power output 31
 - Check Engine warning lamp 225
 - Cleaning instructions 265
 - Display messages (vehicle with steering wheel buttons) 212
 - Display messages (vehicle without steering wheel buttons) 198
 - ECO start/stop function 123
 - Engine number 304
 - Irregular running 125
 - Jump-starting 272
 - Operating safety 31
 - Starting 122
 - Starting problems 125
 - Switching off 135
 - Tow-starting (vehicle) 276
 - Engine electronics**
 - Notes 303
 - Problem (malfunction) 125
 - Engine jump starting**
 - see Jump starting (engine)
 - Engine oil**
 - Adding 253
 - Additives 308
 - Checking the oil level using the dipstick 252
 - Display messages (vehicle with steering wheel buttons) 213
 - Display messages (vehicle without steering wheel buttons) 199
 - Filling capacity 307
 - Information about oil consumption 308
 - Notes about oil grades 307
 - Oil change 308
 - Oil level (note) 252
 - Viscosity 308

Equipment and conversions

see Vehicle bodies

ESC (Electronic Stability Control)

see ESP® (Electronic Stability Program)

ESP® (Electronic Stability Program)

Activating/deactivating (vehicle with steering wheel buttons) 184

Activating/deactivating (vehicle without steering wheel buttons) 174

Crosswind Assist 67

Deactivating/activating 66

Display message (vehicle with steering wheel buttons) 208

Display message (vehicle without steering wheel buttons) 194

Function/notes 65

Important safety information 66

Trailer stabilization 67

Warning lamp 222

Exhaust check 136

Exterior lighting

see Lights

Exterior mirrors

Adjusting 92

Out of position (troubleshooting) 92

Eyeglasses compartment 238

F

First-aid kit 272

Flat tire

Changing a wheel/mounting the spare wheel 297

Fogged up-up windows

see Climate control

Frequencies

Mobile phone 303

Two-way radio 303

Front fog lamps

Changing bulbs 100

Display messages (vehicle with steering wheel buttons) 211

Display messages (vehicle without steering wheel buttons) 197

Switching on/off 95

Front-passenger's seat

see Seats

Fuel

Additives (gasoline) 306

Consumption information 306

Consumption statistics (vehicle with steering wheel buttons) 179

Consumption statistics (vehicle without steering wheel buttons) 172

Displaying the current consumption (vehicle with steering wheel buttons) 178

Displaying the current consumption (vehicle without steering wheel buttons) 173

Displaying the range (vehicle with steering wheel buttons) 178

Displaying the range (vehicle without steering wheel buttons) 173

Driving abroad 137

Driving tips 136

Fuel content display (vehicle without steering wheel buttons) 171

Fuel gauge (vehicle with steering wheel buttons) 39

Grade (gasoline) 305

Important safety notes 305

Problem (malfunction) 133

Refueling 132

Tank content/reserve fuel 305

Fuel content

Display (vehicle without steering wheel buttons) 171

Fuel level

Gauge (vehicle with steering wheel buttons) 39

Fuel tank

Problem (malfunction) 133

Fuel tank

see Fuel tank

Fuel tank reserve level

Display messages (vehicle with steering wheel buttons) 213

Display messages (vehicle without steering wheel buttons) 199

Fuses 276

G

Gasoline 305

Gearshift recommendation

- Display (vehicle with steering wheel buttons) 177
- Display (vehicle without steering wheel buttons) 171

Genuine parts 33

Glove box 238

GTW (Gross Trailer Weight) (definition) 294

Guide rail

- Maximum tensile strength 313

H**Handbrake**

- see Parking brake

Handling control system

- see ESP® (Electronic Stability Program)

Hands-free system

- see Mobile phone

Hazard warning lamps 96

Head restraints

- Adjusting (manually) 89
- Important safety notes 89
- Removing/installing 89

Headlamps

- Changing bulbs (halogen headlamps) 100
- Fogging up 97
- see Automatic headlamp mode

Heating

- see Climate control

High-beam headlamps

- Display messages (vehicle with steering wheel buttons) 210
- Display messages (vehicle without steering wheel buttons) 197
- Replacing bulbs 102
- Switching on/off 96

Hill start assist 123

Hood

- Closing 251
- Display messages (vehicle with steering wheel buttons) 219
- Display messages (vehicle without steering wheel buttons) 202
- Important safety notes 250
- Opening 251

Hydroplaning 139

I**Ignition lock**

- see SmartKey positions (ignition lock)

Immobilizer 67

Indicator lamps

- see Warning and indicator lamps

Indicators

- see Turn signals

Insect protection on the radiator 33

Instrument cluster

- Buttons (vehicle without steering wheel buttons) 171
- Overview (vehicle with steering wheel buttons) 39
- Overview (vehicle without steering wheel buttons) 37
- Warning and indicator lamps (vehicle with steering wheel buttons) 40
- Warning and indicator lamps (vehicle without steering wheel buttons) 38

Instrument cluster lighting 169

Interior lighting

- Automatic control 97
- Delayed switch-off (on-board computer) 188
- General notes 97
- Manual control 98
- Notes on changing bulbs 98
- Overview 97
- Reading lamp 97
- Rear interior light in the grab handle 98
- Replacing bulbs 98
- Switching the cargo compartment lighting on/off (cargo compartment) 98
- Switching the cargo compartment lighting on/off (dashboard) 98
- Switching the rear compartment lighting on centrally 98

J**Jack**

- Holder in the cargo compartment .. 272
- Jacking points 297
- Scope of tire-changing tools 270
- Storage location 270
- Stowage compartment in the rear .. 270
- Stowage space in the cargo compartment 271
- Using 297

Jump starting (engine) 272**K****Key**

- Display messages (vehicle with steering wheel buttons) 219
- Display messages (vehicle without steering wheel buttons) 203
- Position in the ignition lock 121

Kickdown 130**L****Lamps**

- Display messages (vehicle without steering wheel buttons) 196
- see Warning and indicator lamps

Lane detection (automatic)

see Lane Keeping Assist

Lane Keeping Assist

- Activating/deactivating 149
- Display message 215
- Function/information 148
- Setting sensitivity (on-board computer) 185
- Setting the sensitivity 150

Language

- Display (vehicle with steering wheel buttons) 186
- Display (vehicle without steering wheel buttons) 174

Lashing points and tie downs

- Permissible tensile load 312

Lashing strap

- Important safety notes 245
- Tensioning strap 246, 247

LATCH-type (ISOFIX) child seat

- anchors 61

License plate lamp

- Changing bulbs 100

License plate lamps

- Display messages (vehicle with steering wheel buttons) 210
- Display messages (vehicle without steering wheel buttons) 197

Light sensor

- Display messages (vehicle with steering wheel buttons) 210
- Display messages (vehicle without steering wheel buttons) 196

Lighting

see Lights

Lights

- Activating/deactivating the interior lighting delayed switch-off 188
- Automatic headlamp mode 95
- Changing bulbs (halogen headlamps) 100
- Changing bulbs (interior lights) 98
- Display messages (vehicle with steering wheel buttons) 209
- Driving abroad 137
- Fog lamps 95
- Hazard warning lamps 96
- High beam flasher 96
- High-beam headlamps 96
- Important safety notes 94
- Light switch 94
- Low-beam headlamps 95
- Parking lamps 94
- Rear fog lamp 95
- Replacing bulbs (halogen headlamps) 100
- Standing lamps 94
- Switching the daytime running lamps on/off (switch) 95
- Switching the exterior lighting delayed switch-off on/off (on-board computer) 187
- Switching the surround lighting on/off (on-board computer) 187
- Turn signals 96

Limited Warranty 27**Load distribution 243**

- Load protection net** 247
- Loading guidelines** 242
- Loading rails**
- Maximum tensile strength 313
- Loads**
- Securing 244
 - Transporting 242
- Locking**
- see Central locking
- Locking (doors)**
- Emergency locking 71
- Locking centrally**
- see Central locking
- Low-beam headlamps**
- Display messages (vehicle with steering wheel buttons) 209
 - Display messages (vehicle without steering wheel buttons) 196
 - Driving abroad 137
 - Replacing bulbs 101
 - Switching on/off 95
- Lumbar support** 85
- M**
- M+S tires** 279
- Maintenance** 257
- Maintenance points under the hood** 252
- Maximum speed**
- Speed limitation 136
- Mechanical key**
- Function/notes 70
 - Inserting 71
 - Locking vehicle 71
 - Removing 71
- Media Interface**
- Connections 42
- Memory card (audio)** 182
- Mercedes-Benz Commercial Van Center**
- see Qualified specialist workshop
- Mercedes-Benz Service24h** 272
- Message memory**
- On-board computer (vehicle with steering wheel buttons) 203
 - On-board computer (vehicle without steering wheel buttons) 189
- Messages**
- see Warning and indicator lamps
- Mirrors**
- Exterior mirrors 92
 - Important safety notes 91
 - Rear-view mirror 92
 - see Vanity mirror
- Mobile phone**
- Type approval/frequency 303
- Mobile phone**
- see Telephone
- Model designation**
- see Vehicle identification plate
- Modifying the programming (SmartKey)** 70
- Motor oil additives**
- see Additives
- Mounting wheels**
- Lowering the vehicle 299
 - Mounting a new wheel 298
 - Preparing the vehicle 297
 - Raising the vehicle 297
 - Removing a wheel 298
 - Removing and mounting the spare wheel 301
 - Securing the vehicle against rolling away 297
- MP3**
- Operation 182
- Multimedia system**
- Important safety notes 230
- N**
- Navigation**
- Menu (on-board computer) 180
- Notes on breaking-in a new vehicle** 120
- O**
- Occupant Classification System (OCS)**
- Conditions 52
 - Faults 56
 - Operation 53
 - System self-test 55
- Occupant safety**
- Air bags 49

- Automatic measures after an accident 58
- Belt warning 49
- Children in the vehicle 58
- Important safety notes 45
- Introduction to the restraint system 45
- Occupant Classification System (OCS) 52
- PASSENGER AIR BAG indicator lamps 46
- Pets in the vehicle 64
- Restraint system warning lamp 45
- Seat belt 46
- OCS**
 - Conditions 52
 - Faults 56
 - Operation 53
 - System self-test 55
- Odometer**
 - Displaying (vehicle with steering wheel buttons) 178
 - Displaying (vehicle without steering wheel buttons) 172
 - Setting the display unit (vehicle with steering wheel buttons) 186
 - Setting the display unit (vehicle without steering wheel buttons) 175
- Off-road driving**
 - Checklist after driving off-road 141
 - Important safety notes 140
 - Rules for driving off-road 140
- Oil**
 - see Engine oil
- On-board computer (vehicle with steering wheel buttons)**
 - Assistance menu 183
 - Audio menu 181
 - Date menu 187
 - Display messages 203
 - Factory settings 188
 - Important safety notes 169
 - Instrument cluster menu 186
 - Lights menu 187
 - Menu overview 178
 - Message memory 203
 - Navigation menu 180
 - Operating 176
 - Permanent display 186
 - Service menu 185
 - Setting the date 187
 - Setting the display 186
 - Setting the display language 186
 - Setting the language 186
 - Setting the time 187
 - Settings menu 186
 - Standard display 178
 - Telephone menu 182
 - Time menu 187
 - Trip menu 178
 - Vehicle menu 188
- On-board computer (vehicle without steering wheel buttons)**
 - Coolant temperature display menu 173
 - Current fuel consumption menu 173
 - Date menu 176
 - Digital speedometer menu 173
 - Display messages 189
 - Distance menu 172
 - Factory settings 174
 - Important safety notes 169
 - Menu overview 172
 - Message memory 189
 - Operating 171
 - Permanent display 175
 - Range menu 173
 - Setting the date 176
 - Setting the display 175
 - Setting the display language 174
 - Setting the language 174
 - Setting the time 176
 - Settings menu 174
 - Standard display menu 172
 - Time menu 176
 - Trip computer menu 172
- On-board computer (vehicles with steering wheel buttons)**
 - Displaying the service message 258
- On-board computer (vehicles without steering wheel buttons)**
 - Displaying the service message 258
- On-board diagnostics interface**
 - see Diagnostics connection
- Operating Instructions**
 - Before the first journey 27

- Limited Warranty 27
 - Operating safety**
 - Limited Warranty 27
 - Operating safety and vehicle approval**
 - Attachments and bodies 32
 - Changing the engine power output 31
 - Correct use 29
 - Declaration of conformity 31
 - Equipment and conversions 32
 - Important safety notes 30
 - Information about body/equipment mounting directives 32
 - Notes on operating the vehicle 30
 - Qualified specialist workshop 31
 - Registering your vehicle 32
 - Operating system**
 - On-board computer (vehicle with steering wheel buttons) 176
 - On-board computer (vehicle without steering wheel buttons) 171
 - Operator's Manual**
 - General notes 27
 - Vehicle equipment 27
 - Outside temperature display** 170
 - Overhead control panel** 43
 - Overrevving range** 170
 - Overrun cutoff** 136
- P**
- Paint code number** 303
 - Paintwork (cleaning instructions)** ... 265
 - Parking** 133
 - Important safety notes 133
 - Parking brake 134
 - Rear view camera 158
 - see Active Parking Assist
 - see PARKTRONIC
 - Parking aid**
 - Active Parking Assist 154
 - see PARKTRONIC
 - see Rear view camera
 - Parking assistance**
 - see PARKTRONIC
 - Parking brake**
 - Display message (vehicle with steering wheel buttons) 208
 - Display message (vehicle without steering wheel buttons) 195
 - Notes/function 134
 - Warning lamp 134
 - Parking brake**
 - see Parking brake
 - Parking lamps**
 - Changing bulbs 102
 - PARKTRONIC**
 - Deactivating/activating 153
 - Display messages 214
 - Driving system 151
 - Function/notes 151
 - Important safety notes 151
 - Problem (malfunction) 154
 - Range of the sensors 152
 - Roll-back warning 153
 - Trailer towing 154
 - Warning display 153
 - PASSENGER AIR BAG OFF**
 - Indicator lamp 46
 - Passenger compartment air-conditioning system**
 - see Climate control
 - Passenger compartment heating**
 - see Climate control
 - Pedestrian protection**
 - see Hood
 - Pets in the vehicle** 64
 - Plastic trim (cleaning instructions)** 268
 - Power washers** 264
 - Power windows**
 - see Side windows
 - Preparing for a journey**
 - Checks in the vehicle 121
 - Visual check of the vehicle exterior 121
 - Program selector button** 129
 - Protection against theft**
 - see ATA (Anti-Theft Alarm system)
 - Protection of the environment**
 - General notes 29
 - Pulling away**
 - Automatic transmission 122

- Hill start assist 123
- Q**
- QR code**
- Rescue card 34
- Qualified specialist workshop** 31
- R**
- Radiator cover** 33
- Radio**
- Important safety notes 230
- Selecting a station 181
- see separate operating instructions
- Radio-wave reception/transmission in the vehicle**
- Declaration of conformity 31
- Radio/navigation**
- Important safety notes 230
- Rail transport**
- see Transport by rail
- Rain sensor**
- Setting the sensitivity 104
- Setting the sensitivity (vehicle with steering wheel buttons) 188
- Setting the sensitivity (vehicle without steering wheel buttons) 175
- Reading lamp** 97
- Rear bench seat**
- EASY-ENTRY/EXIT feature 87
- General notes 86
- Installation options 86
- Removing/installing (standard rear bench seat) 88
- Seat anchorage 86
- Seat rails 86
- Seating variants 86
- Rear compartment**
- Activating/deactivating climate control 111
- Seating variants 86
- Setting the air vents 118
- Setting the temperature 113
- Switching the interior lighting on/off 98
- Rear door**
- Display messages (vehicle with steering wheel buttons) 219
- Display messages (vehicle without steering wheel buttons) 202
- Important safety notes 79
- Indicator lamp 229
- Opening at an angle of 180° or 270° 81
- Opening dimensions 311
- Opening/closing from inside 80
- Opening/closing from the outside 80
- Rear doors** 79
- Rear fog lamp**
- Display messages (vehicle with steering wheel buttons) 211
- Display messages (vehicle without steering wheel buttons) 197
- Replacing bulbs 103
- Switching on/off 95
- Rear view camera**
- Cleaning instructions 267
- Coupling up a trailer function 162
- Function/notes 158
- General notes 158
- Important safety notes 159
- Messages in the display 160
- Reverse parking 161
- Switching on/off 159
- Rear window defroster**
- Problem (malfunction) 116
- Switching on/off 116
- Rear window wiper**
- Replacing the wiper blade 106
- Switching on/off 104
- Rear-compartment air-conditioning system**
- see Climate control
- Rear-compartment heating**
- see Climate control
- Rear-view mirror**
- Anti-glare (manual) 92
- Recuperation display** 173
- Recycling**
- see Protection of the environment

Refrigerant (air-conditioning system)

Important safety notes 310

Refueling

Fuel filler flap 133

Fuel gauge (vehicle with steering wheel buttons) 39

Fuel gauge (vehicle without steering wheel buttons) 171

Refueling procedure (fuel) 133

see Fuel

Remote control

see Key

Replacing bulbs

Important safety notes 100

Reporting safety defects 32

Rescue card 34

Reserve (fuel tank)

see Fuel

Reserve fuel

Display messages (vehicle with steering wheel buttons) 213

Display messages (vehicle without steering wheel buttons) 199

Warning lamp 225

Residual heat (climate control) 117

Restraint system

Display message (vehicle with steering wheel buttons) 209

Display message (vehicle without steering wheel buttons) 195

Introduction 45

Warning lamp 224

Warning lamp (function) 45

Reverse warning feature 123

Reversing feature

Electric sliding door 76

Side windows 82

Roadside Assistance (breakdown) 28

Roof carrier

Maximum payload 313

Notes 248

Roof lining and carpets (cleaning guidelines)

..... 269

Roof load (roof carrier) 313

S**Safety**

Children in the vehicle 58

Operating safety 30

see Occupant safety

Safety system

see Driving safety systems

Seat belts

Adjusting the height 48

Cleaning 269

Correct usage 48

Fastening 48

Important safety guidelines 47

Introduction 46

Releasing 49

Warning lamp 220

Warning lamp (function) 49

Seats

Adjusting (manually) 85

Adjusting lumbar support 85

Adjusting the head restraint 89

Armrest 90

Cleaning the cover 268

Correct driver's seat position 84

Important safety notes 84

Seat heating 90

Selecting gear

see Automatic transmission

Selector lever

Cleaning 268

see Automatic transmission

Sensors (cleaning instructions) 266

Service interval display

Calling up the service due date 258

Hiding service messages 258

Notes 257

Service menu (on-board computer)

..... 185

Service phone number 272

Service products

Brake fluid 309

Coolant (engine) 309

Engine oil 307

Fuel 305

Important safety notes 304

Refrigerant (air-conditioning system) 310

- Transmission oil 308, 309
- Washer fluid 311
- Setting the air distribution** 114
- Setting the airflow** 114
- Setting the speed**
 - see Cruise control
- Settings**
 - Factory (vehicle with steering wheel buttons) 188
 - Factory (vehicle without steering wheel buttons) 174
 - On-board computer (vehicle with steering wheel buttons) 186
 - On-board computer (vehicle without steering wheel buttons) 174
- Side impact air bag** 51
- Side windows**
 - Cleaning 265
 - Convenience closing feature 83
 - Convenience opening feature 82
 - Hinged side windows 81
 - Important safety information 81
 - Opening/closing 82
 - Overview 81
 - Problem (malfunction) 83
 - Resetting 83
- Signal and ambient light**
 - Changing a bulb 100
- Sliding door**
 - Child-proof locks 63
 - Cleaning 267
 - Important safety notes 74
 - Indicator lamp 229
 - Opening/closing from the inside 75
 - Opening/closing from the outside 75
 - see Electric sliding door
- SmartKey**
 - Changing the battery 72
 - Changing the programming 70
 - Checking the battery 71
 - Convenience closing feature ... 83, 117
 - Convenience opening feature 82
 - Door central locking/unlocking 69
 - Important safety notes 69
 - Loss 72
 - Mechanical key 70
 - Problem (malfunction) 72
- SmartKey positions (ignition lock) ..** 121
- Snow chains** 280
- Sockets** 241
- Spare wheel**
 - General notes 301
 - Important safety notes 301
 - Removing/mounting 301
- Special seat belt retractor** 59
- Specialist workshop** 31
- Speed, controlling**
 - see Cruise control
- Speedometer**
 - Activating/deactivating the additional speedometer (vehicle with steering wheel buttons) 186
 - Activating/deactivating the additional speedometer (vehicle without steering wheel buttons) 175
 - Digital (vehicle with steering wheel buttons) 179
 - Digital (vehicle without steering wheel buttons) 173
 - General notes 170
 - In the instrument cluster (vehicle with steering wheel buttons) 39
 - In the instrument cluster (vehicle without steering wheel buttons) 37
 - Setting the display unit (vehicle with steering wheel buttons) 186
 - Setting the display unit (vehicle without steering wheel buttons) 175
- SRS (Supplemental Restraint System)**
 - see Restraint system
- Standing lamp**
 - Display messages (vehicle with steering wheel buttons) 211
- Standing lamps**
 - Display messages (vehicle without steering wheel buttons) 197
 - Replacing bulbs (front) 102
 - Replacing bulbs (rear) 103
 - Switching on/off 94
- Start/stop function**
 - see ECO start/stop function
- Starting**
 - see Starting (engine)

- Starting (engine)** 122
- Status overview (on-board computer)** 184
- Steering**
- Display messages (vehicle with steering wheel buttons) 219
 - Display messages (vehicle without steering wheel buttons) 202
 - Warning lamps 229
- Steering wheel**
- Adjusting 91
 - Button overview 41
 - Buttons (on-board computer) 176
 - Cleaning 268
 - Paddle shifters 130
- Steering wheel paddle shifters** 130
- Stickers**
- General safety notes 29
- Stowage net** 239
- Stowage spaces**
- see Stowage spaces and stowage compartments
- Stowage spaces and stowage compartments**
- Eyeglasses compartment 238
 - Glove box 238
 - Important safety notes 238
 - Stowage net 239
- Summer opening**
- see Convenience opening feature
- Summer tires** 279
- Sun visor**
- Changing a bulb (mirror lamp) 99
 - Overview 239
- Surround lighting (on-board computer)** 187
- Switching air-recirculation mode on/off** 116
- Switching off the alarm (ATA)** 68
- T**
- Tachometer** 170
- Tail lamps**
- Display messages (vehicle without steering wheel buttons) 196
 - Replacing bulbs 103
- Trailer display messages (vehicle with steering wheel buttons) 210
 - Trailer display messages (vehicle without steering wheel buttons) 196
- Tailgate**
- Changing bulbs (ambient lamp) 99
 - Changing bulbs (signal and ambient light) 100
 - Display messages (vehicle with steering wheel buttons) 219
 - Display messages (vehicle without steering wheel buttons) 202
 - Important safety notes 78
 - Opening dimensions 311
 - Opening/closing from the outside 79
- Tank contents**
- Displaying the range (vehicle with steering wheel buttons) 178
 - Displaying the range (vehicle without steering wheel buttons) 173
- Technical data**
- Capacities 304
 - Cargo tie-down points 312
 - Guide rail 313
 - Loading rails 313
 - Roof carrier 313
 - Tires/wheels 300
 - Trailer tow hitch 313
 - Vehicle data 311
 - Vehicle dimensions 311
- Telephone**
- Accepting a call 183
 - Display message 219
 - Introduction 182
 - Number from the phone book 183
 - Redialing 183
 - Rejecting/ending a call 183
- Temperature**
- Coolant (display in the instrument cluster) 170
 - Coolant (display in the on-board computer) 173
 - Outside temperature 170
 - Setting (climate control) 113
- Theft deterrent systems**
- ATA (Anti-Theft Alarm system) 68
 - Immobilizer 67

Time

Setting (vehicle with steering wheel buttons)	187
Setting the time (vehicle with steering wheel buttons)	187
Setting the time (vehicle without steering wheel buttons)	176

Tire pressure

Calling up (on-board computer)	284
Checking manually	284
Display messages (vehicle with steering wheel buttons)	217
Display messages (vehicle without steering wheel buttons)	201
Important safety notes	284
Maximum	284
Notes	283
Recommended	280
Tables	288
Tire label	281

Tire pressure monitor

Checking the tire pressure electronically	286
Function/notes	284
General notes	284
Important safety notes	285
Restarting	287
Warning lamp	228
Warning message	286

Tire pressure table 288**Tires**

Aspect ratio (definition)	295
Average weight of the vehicle occupants (definition)	294
Bar (definition)	294
Changing a wheel	296
Characteristics	294
Checking	278
Curb weight (definition)	295
Definition of terms	294
Direction of rotation	296
Display messages (vehicle with steering wheel buttons)	217
Display messages (vehicle without steering wheel buttons)	201
Distribution of the vehicle occupants (definition)	296

DOT (Department of Transportation) (definition)	294
DOT, Tire Identification Number (TIN)	293
GAWR (Gross Axle Weight Rating) (definition)	294
GTW (Gross Trailer Weight) (definition)	294
GVW (Gross Vehicle Weight) (definition)	295
GVWR (Gross Vehicle Weight Rating) (definition)	295
Important safety notes	277
Increased vehicle weight due to optional equipment (definition)	294
Information on driving	277
Kilopascal (kPa) (definition)	295
Labeling (overview)	291
Load bearing index (definition)	296
Load index	293
Load index (definition)	295
M+S tires	279
Maximum load on a tire (definition)	295
Maximum loaded vehicle weight (definition)	295
Maximum permissible tire pressure (definition)	295
Maximum tire load	293
Maximum tire load (definition)	295
Optional equipment weight (definition)	295
PSI (pounds per square inch) (definition)	295
Replacing	296
Service life	278
Sidewall (definition)	295
Snow chains	280
Speed rating (definition)	294
Storing	296
Structure and characteristics (definition)	294
Summer tires	279
TIN (Tire Identification Number) (definition)	296
Tire bead (definition)	295
Tire pressure (definition)	295
Tire pressures (recommended)	294

- Tire size designation, load-bearing capacity, speed rating 291
- Tire tread 278
- Tire tread (definition) 295
- Total load limit (definition) 296
- Traction (definition) 296
- TWR (permissible trailer drawbar noseweight) (definition) 296
- Uniform Tire Quality Grading Standards (definition) 294
- Wear indicator (definition) 296
- Wheel and tire combination 300
- Wheel rim (definition) 294
- Wheel/tire combinations 300
- Tool**
see Vehicle tool kit
- Top Tether** 61
- Tow-starting**
Emergency engine starting 276
- Important safety notes 274
- Towing**
If the vehicle is stuck 276
- Installing/removing the towing eye 275
- Towing a trailer**
Active Parking Assist 154
- Axle load, permissible 314
- Cleaning the trailer tow hitch 267
- Coupling up a trailer 165
- Decoupling a trailer 167
- Driving tips 163
- Notes on retrofitting 313
- Power supply 168
- Trailer loads 314
- Towing away**
Important safety guidelines 274
- With both axles on the ground 276
- With the rear axle raised 275
- Towing eye** 270
- Trailer coupling**
see Towing a trailer
- Trailer loads and drawbar noseweights** 167
- Trailer operation**
Lights display messages (vehicle with steering wheel buttons) 209
- Lights display messages (vehicle without steering wheel buttons) 196
- Trailer towing**
Blind Spot Assist 148
- ESP® 67
- PARKTRONIC 154
- Permissible trailer loads and drawbar noseweights 167
- Transmission**
see Automatic transmission
- Transmission oil** 308, 309
- Transmission positions**
Automatic transmission 127
- Display (DIRECT SELECT lever) 128
- Transport**
Lashing straps 245
- Loading guidelines 242
- Stickers 245
- Vehicle 276
- Transport by rail** 137
- Transportation**
Rail 137
- Transportation aids**
Load protection net 247
- Transporting**
Cargo compartment variations 244
- Load distribution 243
- Securing a load 244
- Trim pieces (cleaning instructions)** 268
- Trip computer**
Displaying (vehicle with steering wheel buttons) 179
- Displaying (vehicle without steering wheel buttons) 172
- Resetting (vehicle with steering wheel buttons) 179
- Resetting (vehicle without steering wheel buttons) 172
- Selecting the display units (vehicle with steering wheel buttons) 186
- Selecting the display units (vehicle without steering wheel buttons) 175
- Trip odometer**
Displaying (vehicle with steering wheel buttons) 178
- Displaying (vehicle without steering wheel buttons) 172

- Resetting (vehicle with steering wheel buttons) 179
 - Resetting (vehicle without steering wheel buttons) 172
 - Setting the display unit (vehicle with steering wheel buttons) 186
 - Setting the display unit (vehicle without steering wheel buttons) 175
 - Trip odometer**
see Trip odometer
 - Turn signal**
Changing bulbs (additional turn signals) 102
 - Turn signals**
Display messages (vehicle with steering wheel buttons) 210
 - Display messages (vehicle without steering wheel buttons) 196
 - Replacing bulbs (front) 102
 - Replacing bulbs (rear) 103
 - Switching on/off 96
 - Trailer display messages (vehicle with steering wheel buttons) 209
 - Trailer display messages (vehicle without steering wheel buttons) 196
 - Two-way radios**
Type approval/frequency 303
 - TWR (Tongue Weight Rating) (definition)** 296
 - Type identification plate**
see Vehicle identification plate
- U**
- Unlocking**
Emergency unlocking 71
 - From inside the vehicle (central unlocking button) 73
 - With emergency key element 70
 - USB (audio)**
Playing 182
- V**
- Vanity mirror**
Changing a bulb (mirror lamp) 99
 - Sun visor 239
 - Vehicle**
Data acquisition 34
 - Display messages (vehicle with steering wheel buttons) 218
 - Display messages (vehicle without steering wheel buttons) 202
 - Electronics 303
 - Emergency unlocking 70
 - Equipment 27
 - Limited Warranty 27
 - Loading 288
 - Locking (in an emergency) 71
 - Locking (SmartKey) 69
 - Lowering 299
 - Maintenance 28
 - Operating safety 30
 - Parking for a long period 135
 - Pulling away 122
 - Raising 297
 - Registration 32
 - Reporting problems 32
 - Securing from rolling away 133
 - Towing away 274
 - Transporting 276
 - Unlocking (in an emergency) 71
 - Unlocking (SmartKey) 69
 - Vehicle battery**
see Battery (vehicle)
 - Vehicle bodies** 32
Body/equipment mounting directives for trucks 32
 - Vehicle check**
see Preparing for a journey
 - Vehicle data** 311
 - Vehicle dimensions** 311
 - Vehicle emergency locking** 71
 - Vehicle identification number**
see VIN
 - Vehicle identification plate** 303
 - Vehicle key**
see SmartKey
 - Vehicle tool kit**
in the seat base 270
 - Scope 270
 - Storage location 270
 - Stowage compartment in the rear .. 270
 - Stowage space in the cargo compartment 271

Ventilation

see Climate control

VIN

Engine compartment 304
Type plate 303

W**Warning**

Stickers 29

Warning and indicator lamps

ABS 222
Brakes 221
Check Engine 225
COLLISION PREVENTION ASSIST .. 227
Coolant 225
Distance warning 227
Door 229
ESP® 222
ESP® OFF 224
Fuel tank 225
General notes 219
Overview (vehicle with steering wheel buttons) 40
Overview (vehicle without steering wheel buttons) 38
Parking brake 134
PASSENGER AIR BAG OFF 46
Rear door 229
Reserve fuel 225
Restraint system 224
Seat belt 220
Sliding door 229
Steering 229
Tire pressure monitor 228

Warranty 27

Washer fluid

Adding 256
Capacities 311
Display messages (vehicle with steering wheel buttons) 219
Display messages (vehicle without steering wheel buttons) 203
Notes 311

Wheel and tire combination

see Tires

Wheel bolt tightening torque 299

Wheels

Changing a wheel 296
Checking 278
Cleaning 266
Important safety notes 277
Interchanging/changing 296
Mounting a new wheel 298
Mounting a wheel 297
Removing a wheel 298
Removing and mounting the spare wheel 301
Snow chains 280
Storing 296
Tightening torque 299
Wheel/tire combinations 300

Window curtain air bag

Display message (vehicle with steering wheel buttons) 209
Display message (vehicle without steering wheel buttons) 195
Operation 52

Windows

see Side windows

Windshield

Cleaning 265
Defrosting 115

Windshield washer fluid

Adding 256

Windshield wiper

Setting the sensitivity of the rain sensor (vehicle with steering wheel buttons) 188
Setting the sensitivity of the rain sensor (vehicle without steering wheel buttons) 175

Windshield wiper

see Windshield

Windshield wipers

Problem (malfunction) 107
Rear window wiper 104
Replacing the wiper blades 105
Switching on/off 104

Winter driving

Slippery road surfaces 139
Snow chains 280

Winter operation

General notes 279
Radiator cover 33

Winter tires

M+S tires	279
Setting a limit speed	136

Wiper blades

Cleaning	266
Important safety notes	105
Replacing (rear window)	106
Replacing (windshield)	105
Service indicator	105

Workshop

see Qualified specialist workshop

Operating Instructions

Before the first journey

These instructions, the Maintenance or Service Booklet and the additional equipment-specific instructions are integral parts of the vehicle. Keep these documents in the vehicle at all times. If you sell the vehicle, always pass on all documents to the new owner.

Before you first drive off, read these documents carefully and familiarize yourself with your vehicle.

For your own safety and a longer vehicle life, follow the instructions and warning notices in these Operating Instructions. Failure to observe the instructions may lead to damage to the vehicle or personal injury.

Vehicle damage caused by a failure to observe the instructions is not covered by the New Vehicle Limited Warranty.

Limited warranty

I Follow the instructions in this manual about the proper operation of your vehicle as well as about possible vehicle damage. Damage to your vehicle that arises from culpable contraventions against these instructions is not covered either by the Mercedes-Benz Limited Warranty or by the New or Used-Vehicle Warranty.

Vehicle equipment

These Operating Instructions describe all models and standard and optional equipment of your vehicle that were available at the time of going to print. Country-specific variations are possible. Note that your vehicle may not be equipped with all of the described functions. This also applies to systems and functions relevant to safety. The equipment in your vehicle may therefore differ from that shown in the descriptions and illustrations.

The original purchase contract documentation for your vehicle contains a list of all of the systems in your vehicle.

Questions concerning equipment or operation can be directed to any Mercedes-Benz Commercial Van Center.

Service and vehicle operation

Warranty

The Limited Warranty for your vehicle is in accordance with the warranty terms in the Service and Warranty Information booklet.

Your Mercedes-Benz Commercial Van Center will replace and repair all factory-installed parts in accordance with the terms of the following warranties:

- New Vehicle Limited Warranty
- Exhaust System Warranty
- Emission Systems Warranty
- California, Connecticut, Maine, Massachusetts, New York, Pennsylvania, Rhode Island and Vermont Emission Control System Warranty
- State Warranty Enforcement Laws ("Lemon Laws")

Replacement parts and accessories are covered by the Mercedes-Benz Parts and Accessories Warranties. You can obtain these from any Mercedes-Benz Commercial Van Center.

i Should you lose your Service and Warranty Information booklet, contact a Mercedes-Benz Commercial Van Center for a replacement. The new Service and Warranty Information booklet will be posted to you.

Customer information for California

In California you are entitled to demand that your vehicle be exchanged or that the purchase or leasing price be refunded if Mercedes-Benz USA, LLC and/or authorized workshops or service centers are not able, after several justifiable repairs, to rectify major damage to or malfunctions of the vehicle as covered by the contractual warranty provisions. Customers who purchase or lease a vehicle can have the vehicle repaired within a period of 18 months after delivery or after a mileage of up to 29,000 km (equals approx. 18,000 miles), whichever comes first, if:

- (1) the same serious defect or damage which could lead to fatal or serious injuries to the occupants of the vehicle during driving has been repaired at least twice and Mercedes-

Benz, LLC has been informed in writing of the necessity of such a repair.

- (2) the same defect or damage, although less serious than described in (1), has been repaired at least four times and Mercedes-Benz has been informed of the necessity of such a repair in writing.
- (3) the vehicle cannot be operated for more than 30 calendar days due to repairs resulting from the same or other major defects or damage.

Please send written notification to:
Mercedes-Benz USA, LLC
Customer Assistance Center
One Mercedes Drive
Montvale, NJ 07645-0350

Maintenance

USA only:

Always bring the Maintenance Booklet with you when taking the vehicle to a Mercedes-Benz Commercial Van Center. Your customer service advisor enters each service into the Maintenance Booklet.

Canada only:

Have every service carried out by a qualified specialist workshop recorded in your service report.

Roadside Assistance

The Mercedes-Benz Roadside Assistance Program provides you with technical assistance in the case of a breakdown. Your toll-free calls to the Roadside Assistance Hotline are answered by our staff around the clock. 365 days a year.

1-800-FOR-MERCEDES (1-800-367-6372)
(USA)

1-800-387-0100 (Canada)

Further information can be found in the Mercedes-Benz Roadside Assistance-Program brochure (USA) or the "Roadside Assistance" section of the Service and Warranty Information booklet (Canada). Both are located in your vehicle document wallet.

Change of address or owner

Please use the "Notice of Change of Address" form in the Service and Warranty Information booklet to inform us of a change of address, or simply phone the Mercedes-Benz Customer Assistance Center (USA) on hotline number 1-800-FOR-MERCEDES (1-800-367-6372) or Customer Service (Canada) on 1-800-387-0100. This enables us, if necessary, to contact you at any time.

If you sell your Mercedes, please leave all the literature in the vehicle so that it is available for the next owner.

If your vehicle was purchased as a used vehicle, please send us the "Notice of Purchase of Used Car" from the Service and Warranty Information booklet or phone the Mercedes-Benz Customer Assistance Center (USA) on hotline number 1-800-FOR-MERCEDES (1-800-367-6372) or Customer Service (Canada) on 1-800-387-0100.

Operating the vehicle outside of the USA and Canada

When traveling abroad with your vehicle, observe the following points:

- Service facilities or replacement parts may not be available immediately.
- Unleaded fuel for vehicles with a catalytic converter may not be available. Leaded fuel can cause damage to the catalytic converter.
- The fuel may have a considerably lower octane rating. Unsuitable fuel can cause engine damage.

Certain Mercedes-Benz models are available in Europe through our European Delivery Program. Please consult a Mercedes-Benz Commercial Van Center for further information, or write to one of the following addresses:

In the USA

Mercedes-Benz USA, LLC
European Delivery Department
One Mercedes Drive
Montvale, NJ 07645-0350

In Canada

Mercedes-Benz Canada, Inc.
European Delivery Department
98 Vanderhoof Avenue
Toronto, Ontario M4G 4C9

Proper use

Observe the following information when operating your vehicle:

- the safety notes in these operating instructions
- the technical data in these Operating Instructions
- traffic laws and regulations
- motor vehicle laws and safety standards

There are various warning stickers affixed to the vehicle. If you remove warning stickers, you and others may fail to recognize the dangers. Leave the warning stickers in their original position.

WARNING

Modifications to electronic components, their software as well as wiring can impair their function and/or the function of other networked components. In particular, systems relevant to safety could also be affected. As a result, these may no longer function as intended and/or jeopardize the operating safety of the vehicle. There is an increased risk of an accident and injury.

Never tamper with the wiring as well as electronic components or their software. You should have all work to electrical and electronic equipment carried out at a qualified specialist workshop.

The general operating permit for your vehicle could be rendered invalid if you carry out modifications to electronic components, their software as well as wiring.

WARNING

Gases and fluids from substances that constitute a health hazard or react aggressively can escape even from securely closed containers. When transporting such substances in the vehicle interior, your ability to concentrate or your health could be affected during the journey. Malfunctions, short circuits or electrical component system failures may also result. There is a risk of an accident and fire.

Do not store or transport any substances in the vehicle interior which are hazardous to health or react aggressively.

These instructions must also be observed for vehicles where the cargo compartment is not fully separated from the driver's cab.

Partition with door/window: always keep the door/window in the partition closed during transport.

Examples of substances that are hazardous to health and/or react aggressively:

- Solvents
- Fuel
- Oil and grease
- Cleaning agents
- Acids

Protection of the environment

Economic and environmentally aware driving

Environmental note

Daimler's declared policy is one of comprehensive environmental protection.

The objectives are for the natural resources that form the basis of our existence on this planet to be used sparingly and in a manner that takes the requirements of both nature and humanity into account.

You too can help to protect the environment by operating your vehicle in an environmentally responsible manner.

Fuel consumption and the rate of engine, transmission, brake and tire wear are affected by these factors:

- operating conditions of your vehicle
- your personal driving style

You can influence both factors. You should bear the following in mind:

Operating conditions:

- avoid short trips as these increase fuel consumption.
- always make sure that the tire pressures are correct.
- do not carry any unnecessary weight.
- remove roof racks once you no longer need them.
- a regularly serviced vehicle will contribute to environmental protection. You should therefore adhere to the service intervals.
- always have service work carried out at a qualified specialist workshop.

Personal driving style:

- do not depress the accelerator pedal when starting the engine.
- do not warm up the engine when the vehicle is stationary.
- drive carefully and maintain a safe distance from the vehicle in front.
- avoid frequent, sudden acceleration and braking.
- change gear in good time and use each gear only up to $\frac{2}{3}$ of its maximum engine speed.
- switch off the engine in stationary traffic.
- keep an eye on the vehicle's fuel consumption.

Environmental issues and recommendations

When prompted by this Operator's Manual to dispose of materials, please try to regenerate and recycle these materials. Observe all relevant environmental guidelines and regulations when disposing of materials. This helps to protect the environment.

Operating safety and vehicle approval**Important safety notes** **WARNING**

If you do not have the prescribed service/maintenance work or any required repairs carried out, this can result in malfunctions or system failures. There is a risk of an accident.

Always have the prescribed service/maintenance work as well as any required repairs carried out at a qualified specialist workshop.

Air bags and pyrotechnic Emergency Tensioning Devices (ETDs) contain perchlorate material which may require special handling and regard for the environment. The guidelines must be observed during disposal.

In California, you can find more information on the Internet at www.dtsc.ca.gov.

Notes on operating the vehicle

There is a risk of damage to the vehicle if:

- the vehicle makes contact with the ground, e.g. on a high curb or a loose road surface
- you drive too quickly over an obstacle, e.g. a curb, speed bump or pothole
- a heavy object hits the underbody or chassis component

In these or similar situations, the vehicle body/frame, the underbody, chassis components, wheels or tires could be damaged even if this is not visible from the outside. Components that have been damaged in this way can unexpectedly fail or no longer be able to assimilate the loads occurring in the event of an accident. If the underbody paneling is damaged, flammable material, such as leaves, grass or twigs, could collect between the underbody and underbody paneling. These materials could ignite if they remain in contact with hot components of the exhaust system for an extended period.

 **WARNING**

Flammable material such as leaves, grass or twigs may ignite if they come into contact with hot parts of the exhaust system. There is a risk of fire.

When driving off road or on unpaved roads, check the vehicle's underside regularly. In particular, remove parts of plants or other flammable materials which have become trapped. In the case of damage, contact a qualified specialist workshop.

Have the vehicle checked and repaired immediately at a qualified specialist workshop. If you become aware when continuing the journey that driving safety has been effected, stop as soon as possible in accordance with the traffic conditions. In such cases, consult a qualified specialist workshop.

Declaration of conformity

Radio-based vehicle components

USA: "The wireless devices of this vehicle comply with Part 15 of the FCC Rules. Operation is subject to the following two conditions: 1) These devices may not cause harmful interference. 2. This device must accept any interference received, including interference that may cause undesired operation. Changes or modifications not expressly approved by the party responsible for compliance could void the user's authority to operate the equipment."

Canada: "The wireless devices of this vehicle comply with Industry Canada license-exempt RSS standard(s). Operation is subject to the following two conditions: 1) These devices may not cause interference, and 2) these devices must accept any interference received, including interference that may cause undesired operation of the device".

Diagnostics connection

The diagnostics connection is only intended for the connection of diagnostic equipment at a qualified specialist workshop.

WARNING

If you connect equipment to a diagnostics connection in the vehicle, it may affect the operation of vehicle systems. As a result, the operating safety of the vehicle could be affected. There is a risk of an accident.

Only connect equipment to a diagnostics connection in the vehicle, which is approved for your vehicle by Mercedes-Benz.

Changing the engine power output

! Increases in engine power can:

- change the emission values
- cause malfunctions
- cause consequential damage

The operating reliability of the engine is not guaranteed in all cases.

Any tampering with the engine management system in order to increase the engine power output will lead to the loss of the New Vehicle Limited Warranty and other warranty entitlements.

If you sell the vehicle, inform the purchaser about the changes to the engine power output of the vehicle. If you do not inform the buyer, this may constitute a punishable offense under national legislation.

Qualified specialist workshops

A Mercedes-Benz Commercial Van Center is a qualified specialist workshop.

A qualified specialist workshop has the necessary specialist knowledge, tools and qualifications to correctly carry out the work required on the vehicle.

This is especially the case for work relevant to safety. Observe the notes in the Maintenance or Service Booklet.

The following work should always be carried out at qualified specialist workshop:

- work relevant to safety
- service and maintenance work
- repair work
- modifications as well as installations and alterations
- work on electronic components

Mercedes-Benz recommends that you use a Mercedes-Benz Commercial Van Center.

! Only have work carried out on the engine electronics and its associated parts, such as control units, sensors, actuating components and connector leads, at a qualified specialist

workshop. Vehicle components may otherwise wear more quickly and the vehicle's operating permit may be invalidated.

Problems with your vehicle

If you should experience problems with your vehicle, particularly ones which may affect vehicle safety, please contact a Mercedes-Benz Commercial Van Centerto have the problem diagnosed and rectified. If the problem is not dealt with to your satisfaction there, please contact a Mercedes-Benz Commercial Van Center again or write to one of the following addresses.

In the USA

Customer Assistance Center
Mercedes-Benz USA, LLC
One Mercedes Drive
Montvale, NJ 07645-0350

In Canada

Customer Relations Department
Mercedes-Benz Canada, Inc.
98 Vanderhoof Avenue
Toronto, Ontario M4G 4C9

Reporting malfunctions relevant to safety

USA only:

The following text is published as required of all manufacturers under Title 49, Code of U.S. Federal Regulations, Part 575 pursuant to the "National Traffic and Motor Vehicle Safety Act of 1966".

If you believe that your vehicle has a defect which could cause a crash or could cause injury or death, you should immediately inform the National Highway Traffic Safety Administration (NHTSA) in addition to notifying Mercedes-Benz USA, LL.

If NHTSA receives similar complaints, it may open an investigation, and if it finds that a safety defect exists in a group of vehicles, it may order a recall and remedy campaign. However, NHTSA cannot become involved in individual problems between you, your dealer, or Mercedes-Benz USA, LL.

To contact NHTSA, you may call the Vehicle Safety Hotline toll-free at 1-888-327-4236 (TTY: 1-800-424-9153); go to [http://](http://www.safercar.gov)

www.safercar.gov; or write to: Administrator, NHTSA, 400 Seventh Street, SW., Washington, DC 20590.

You can find more information on vehicle safety at:

<http://www.safercar.gov>

Registering your vehicle

Mercedes-Benz may instruct its Mercedes-Benz Commercial Van Center to carry out technical inspections on certain vehicles. This is always the case if the quality or safety of the vehicle is improved as a result of the inspection.

Mercedes-Benz can only inform you about vehicle checks if it has your registration data.

Your registration data is not stored if:

- you did not purchase your vehicle at a Mercedes-Benz Commercial Van Center
- your vehicle was not inspected at a Mercedes-Benz Commercial Van Center

It is advisable to register your vehicle with a Mercedes-Benz Commercial Van Center. Inform Mercedes-Benz as soon as possible about any change of address or vehicle ownership.

Attachments, bodies, equipment and conversions

Information about body/equipment mounting directives

I For safety reasons, have bodies manufactured and installed in accordance with the valid Mercedes-Benz body/equipment mounting directives. These body/equipment mounting directives guarantee that the chassis and add-on equipment form a cohesive whole and that the highest possible level of operating and driving safety is reached.

For safety reasons, Mercedes-Benz recommends that:

- no other modifications be made to the vehicle.
- approval be obtained from Mercedes-Benz in the event of deviations from approved body/equipment mounting directives.

Approval by official testing centers or permission given by authorities do not eliminate safety risks.

Please observe the information concerning Mercedes-Benz Genuine Parts (> page 33). You can obtain further information from any Mercedes-Benz Commercial Van Center.

WARNING

The function of systems or components can be affected by conversions or modifications to the vehicle. They might not function properly anymore and/or jeopardize the operational safety of the vehicle. There is an increased risk of an accident and injury.

Conversions or modifications should always be carried out at qualified specialist workshop.

If you intend to make modifications to your vehicle, we strongly recommend that you contact the distributor named on the inside of the front cover. There you will receive all the necessary information and a charge may be levied.

You alone accept the responsibility if body manufacturers or dealers make modifications that affect the final certification of the engine, the vehicle or the equipment. This also applies to the identification and documentation of modifications to the affected vehicle components.

You are responsible for certification and confirmation that:

- all the applicable standards and regulations that are affected by the vehicle modification are met
- the modified vehicle fulfills the vehicle safety standards and emissions laws and regulations
- the modifications or installation of accessories does not affect the safety of the vehicle

We are not responsible for the final certification, product liability or warranty claims which result from the modifications. This applies to:

- the modified components, assemblies or systems
- any resulting noncompliance with any of the emissions laws and regulations or the motor vehicle safety standards
- any consequences arising from the changes that make the vehicle less safe or even render it defective

We do not assume responsibility as the final-stage manufacturer or for the consequential product liability.

Notes on the radiator

Even seemingly small changes to the vehicle, such as attaching a radiator trim for winter driving, is not permitted. Do not cover up the radiator. Do not use thermal mats, insect protection covers or anything similar.

Otherwise, the values of the diagnostic system may be affected. Some of these values are legally prescribed and must always be correct.

Genuine Mercedes-Benz parts

 Air bags and Emergency Tensioning Devices, as well as control units and sensors for these restraint systems, may be installed in the following areas of your vehicle:

- doors
- door pillars
- door sills
- seats
- cockpit
- instrument cluster
- center console

Do not install accessories such as audio systems in these areas. Do not carry out repairs or welding. You could impair the operating efficiency of the restraint systems.

Have aftermarket accessories installed at a qualified specialist workshop.

Environmental note

We supply reconditioned assemblies and parts which are of the same quality as new parts. The same New Vehicle Limited Warranty applies as for new parts.

The operating safety of the vehicle could be jeopardized if you use parts, tires and wheels as well as accessories relevant to safety which have not been approved by Mercedes-Benz. This could lead to malfunctions in safety-relevant systems, e.g. the brake system. Only use genuine Mercedes-Benz parts or parts of equal quality. Only use tires, wheels and accessories that have been specifically approved for your vehicle.

Mercedes-Benz tests genuine Mercedes-Benz parts, conversion parts and accessories that have been specifically approved for the type of vehicle for:

- Reliability
- Safety
- Suitability

Despite ongoing market research, Mercedes-Benz is unable to assess other parts. Even if an independent or official approval has been provided in exceptional cases, Mercedes-Benz accepts no responsibility for the use of such parts in Mercedes-Benz vehicles.

In some countries, certain parts are only officially approved for installation or modification if they comply with legal requirements. All genuine Mercedes-Benz parts satisfy these requirements. Make sure that all parts are suitable for your vehicle.

Always specify the vehicle identification number (VIN) (> page 303) and engine number when ordering genuine Mercedes-Benz parts (> page 304).

QR code for rescue card

The QR Code stickers are affixed to the B-pillar on the driver's and front-passenger side.

In the event of an accident the rescue services use the QR Code to quickly find the rescue card for your vehicle. The current rescue card contains the most important information on your vehicle, e.g. the electric cable routes, in a compact form.

Further information can be found at <http://www.mercedes-benz.de/qr-code>.

Data stored in the vehicle

Data Recording

A wide range of electronic components in your vehicle contain data memories.

These data memories temporarily or permanently store technical information about:

- the vehicle's operating state
- events
- faults

In general, this technical information documents the state of a component, a module, a system or the surroundings.

These include, for example:

- operating conditions of system components, e.g. fluid levels
- the vehicle's status messages and those of its individual components, e.g. number of wheel revolutions/speed, deceleration in movement, lateral acceleration, accelerator pedal position
- malfunctions and defects in important system components, e.g. lights, brakes
- vehicle reactions and operating conditions in special driving situations, e.g. airbag deployment, intervention of stability control systems
- ambient conditions, e.g. outside temperature

This data is of an exclusively technical nature and can be used to:

- assist in detecting and rectifying faults and defects
- analyze vehicle functions, e.g. after an accident
- optimize vehicle functions

The data cannot be used to trace the vehicle's movements.

When your vehicle is serviced, technical information can be read from the event data memory and fault data memory.

Services include, for example:

- repair services
- service processes
- warranty events
- quality assurance

The vehicle is read out by employees of the service network (including the manufacturer) using special diagnostic testers. You can obtain more information there, if required.

After a fault has been rectified, the information is deleted from the fault memory or is continually overwritten.

When operating the vehicle, situations are conceivable in which this technical data, in connection with other information (if necessary, after consultation with an authorized expert), could be traced to a person.

Examples include:

- accident reports
- damage to the vehicle
- witness statements

Further additional functions that have been contractually agreed upon with the customer allow certain vehicle data to be conveyed by the vehicle as well. The additional functions include, for example, vehicle location in case of an emergency.

Event Data Recorders

This vehicle is equipped with an event data recorder (EDR). The main purpose of an EDR is to record, in certain crash or near crash-like situations, such as an air bag deployment or hitting a road obstacle, data that will assist in understanding how a vehicle's systems performed. The EDR is designed to record data related to vehicle dynamics and safety systems for a short period of time, typically 30 seconds or less. The EDR in this vehicle is designed to record such data as:

- How various systems in your vehicle were operating;
- Whether or not the driver and passenger safety belts were buckled/fastened;
- How far (if at all) the driver was depressing the accelerator and/or brake pedal; and,
- How fast the vehicle was traveling.

These data can help provide a better understanding of the circumstances in which crashes and injuries occur. NOTE: EDR data are recorded by your vehicle only if a non-trivial crash situation occurs; no data are recorded by the EDR under normal driving conditions and no personal data (e.g., name, gender, age, and crash location) are recorded. However, other parties, such as law enforcement could combine the EDR data with the type of personally identifying data routinely acquired during a crash investigation.

Access to the vehicle and/or the EDR is needed to read data that is recorded by an EDR, and special equipment is required. In addition to the vehicle manufacturer, other parties that have the special equipment, such as law enforcement, can read the information by accessing the vehicle or the EDR.

EDR data may be used in civil and criminal matters as a tool in accident reconstruction, acci-

dent claims, and vehicle safety. Since the Crash Data Retrieval CDR tool that is used to extract data from the EDR is commercially available, Mercedes-Benz USA, LLC ("MBUSA") expressly disclaims any and all liability arising from the extraction of this information by unauthorized Mercedes-Benz personnel.

MBUSA will not share EDR data with others without the consent of the vehicle owners or, if the vehicle is leased, without the consent of the lessee. Exceptions to this representation include responses to subpoenas by law enforcement; by federal, state or local government; in connection with or arising out of litigation involving MBUSA or its subsidiaries and affiliates; or, as required by law.

Warning: The EDR is a component of the Restraint System Module. Tampering with, altering, modifying or removing the EDR component may result in a malfunction of the Restraint System Module and other systems.



State laws or regulations regarding EDRs that conflict with federal regulation are pre-empted. This means that in the event of such conflict, the federal regulation governs. As of February 2013, 13 states have enacted laws relating to EDRs.

Cockpit

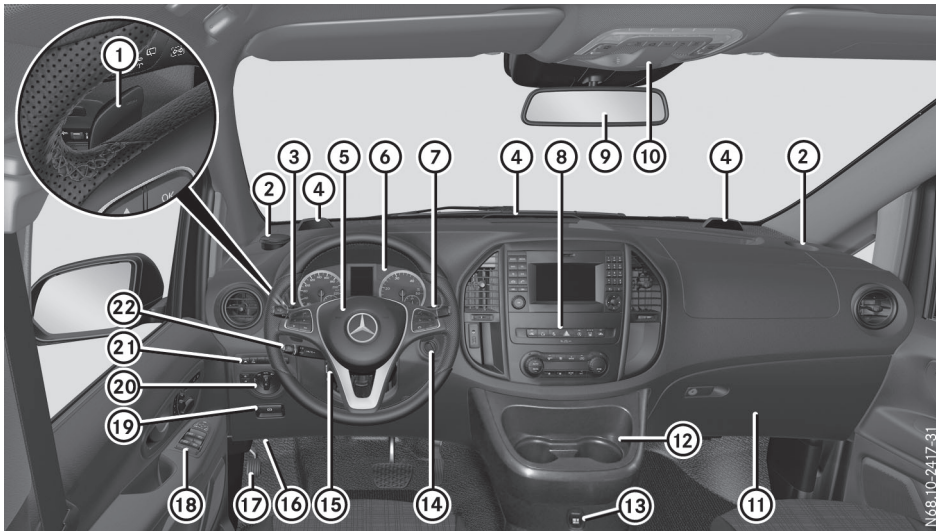
At a glance



	Function	Page
①	Steering wheel paddle shifters	130
②	• Cup holder • Ashtray	239 240
③	Combination switch	96
④	PARKTRONIC warning indicators	151
⑤	Horn	
⑥	• Instrument cluster (vehicle without steering wheel buttons) • Instrument cluster (vehicle with steering wheel buttons)	37 39
⑦	DIRECT SELECT lever	126
⑧	Center console control panel	42
⑨	Rear-view mirror	91
⑩	• Overhead control panel • Interior lamp	43 97
⑪	Glove box	238
⑫	Cup holder	239

	Function	Page
⑬	• 12 V socket • Cigarette lighter	241 240
⑭	Ignition lock	121
⑮	Adjusts the steering wheel	91
⑯	Diagnostics connection Opens the hood	31 251
⑰	Applies the parking brake	134
⑱	Door control panel	43
⑲	Releases the parking brake	134
⑳	Light switch	94
㉑	• Coin/card holder • Driving system control panel  Deactivates/activates Lane Keeping Assist  Deactivates/activates PARKTRONIC	148 151
㉒	Cruise control lever	142

Instrument cluster (vehicles without steering wheel buttons)

Displays and controls

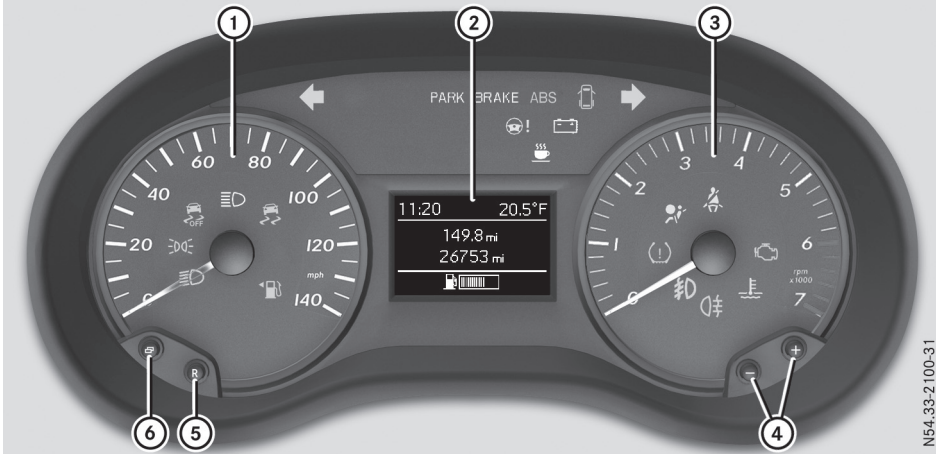

At a glance

N54.33-2100-31

	Function	Page		Function	Page
①	Speedometer	170	⑤	(R) Selects a submenu or reset values	171
②	Display	171	⑥	(☰) Selects the menu or display	171
③	Tachometer	170			
④	(+), (-) Adjusts the instrument cluster lighting	169			
	Changes values or settings or scrolls in lists	171			

i You can find information about displaying the outside temperature or the coolant temperature in the display under:

- "Outside temperature display" (▷ page 170)
- "Coolant temperature gauge" (▷ page 170)

Indicator and warning lamps

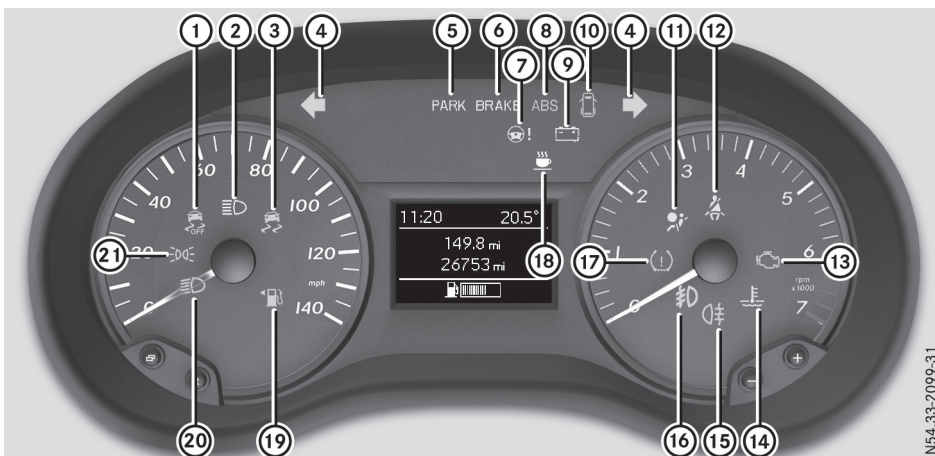

N54.33-2099-31

	Function	Page
①	ESP® OFF	224
②	High-beam headlamps	96
③	ESP®	222
④	Turn signal	96
⑤	Parking brake (USA only) (Canada only)	134
⑥	Brakes (USA only) (Canada only)	221
⑦	Power steering	229
⑧	ABS	222
⑨	Battery	198
⑩	Doors	229

	Function	Page
⑪	Restraint system	45
⑫	Seat belt	220
⑬	Check Engine	225
⑭	Coolant	225
⑮	Rear fog lamp	95
⑯	Front fog lamps	95
⑰	Tire pressure monitor	228
⑱	ATTENTION ASSIST	150
⑲	Reserve fuel	225
⑳	Low-beam headlamps	95
㉑	Parking lamps and license plate lamp	94

i Corresponding messages may also be shown in the display (> page 189).

Instrument cluster (vehicles with steering wheel buttons)

Displays and controls

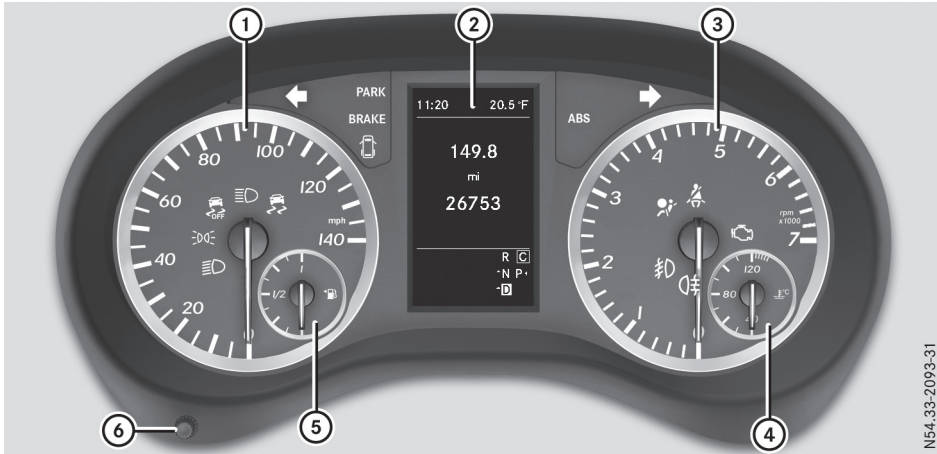

At a glance

N54.33-2093-31

	Function	Page		Function	Page
①	Speedometer	170	⑤	Fuel level Fuel filler flap location indicator  : the fuel filler cap is on the left-hand side	
②	Display	177	⑥	Adjusts the instrument cluster lighting	169
③	Tachometer	170			
④	Coolant temperature gauge	170			

i Information on the outside temperature display can be found under "Outside temperature display" (> page 170).

Indicator and warning lamps

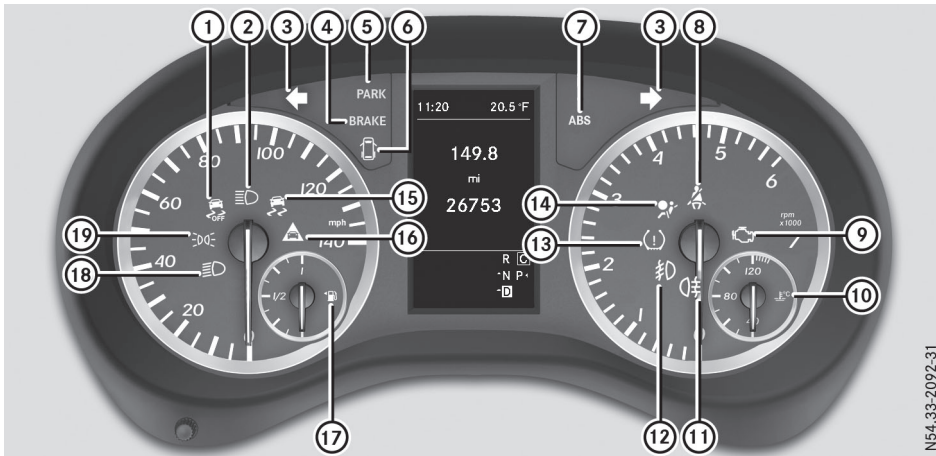

N54.33-2092-31







	Function	Page
①	ESP® OFF	224
②	High-beam headlamps	96
③	Turn signal	96
④	Brakes (USA only) (Canada only)	221
⑤	Parking brake (USA only) (Canada only)	134
⑥	Doors	229
⑦	ABS	222
⑧	Seat belt	220
⑨	Check Engine	225

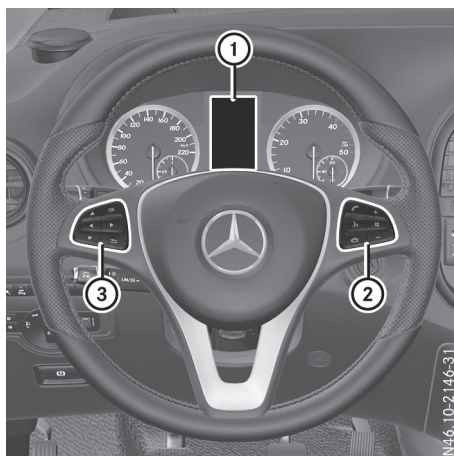





	Function	Page
⑩	Coolant	225
⑪	Rear fog lamp	95
⑫	Front fog lamps	95
⑬	Tire pressure monitor	228
⑭	Restraint system	45
⑮	ESP®	222
⑯	Distance warning signal	227
⑰	Reserve fuel	225
⑱	Low-beam headlamps	95
⑲	Parking lamps and license plate lamp	94

i Corresponding messages may also be shown in the display (▷ page 203).

Steering wheel buttons



	Function	Page
①	Display	177
②	 Rejects or ends a call Exits the telephone book/ redial memory	182
	 Makes or accepts a call Switches to the redial mem- ory	182
	  Adjusts the volume	
	 Mutes	
	 Vehicles with a navigation system: switches on voice- operated control of the navi- gation system (see the man-	

	Function	Page
	manufacturer's operating instructions)	
③	  Calls up the menu bar in the display and selects menus	176
	  Selects a submenu or func- tion or scrolls through lists	176
	 Confirms your selection	176
	 Hides display messages	203
	 Back	176
	Vehicles with a navigation system: switches off voice- operated control of the navi- gation system (see the man- ufacturer's operating instructions)	

i The multimedia system, telephone and voice-operated control using the steering wheel buttons in the right control panel only function with a Mercedes-Benz audio or nav-





igation system. If you are using an audio or navigation system from another manufacturer, the described functions may be restricted or not available at all.

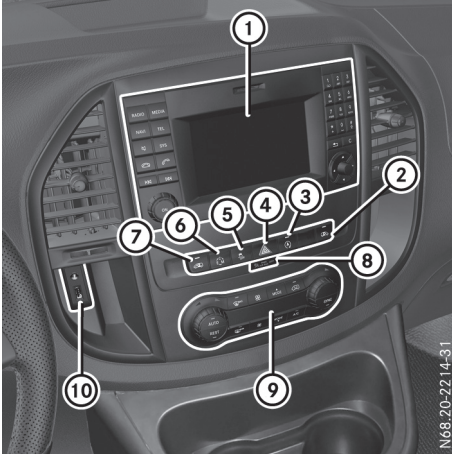

Center console

Control panel

At a glance



	Function	Page
①	Audio system (see separate operating instructions)	
②	 Opens and closes the electric sliding door on the right side of the vehicle	77
③	 Activates and deactivates the ECO start/stop function	123
④	 Switches hazard warning lamps on and off	96
⑤	 Deactivates and activates ESP®	66

	Function	Page
⑥	 Selects the drive program	129
⑦	 Opens and closes the electric sliding door on the left side of the vehicle	77
⑧	PASSENGER AIR BAG OFF indicator lamp	46
⑨	Air-conditioning control panel	108
⑩	Media Interface with AUX jack and USB port	

The number and arrangement of the buttons is equipment-dependent.

Overhead control panel

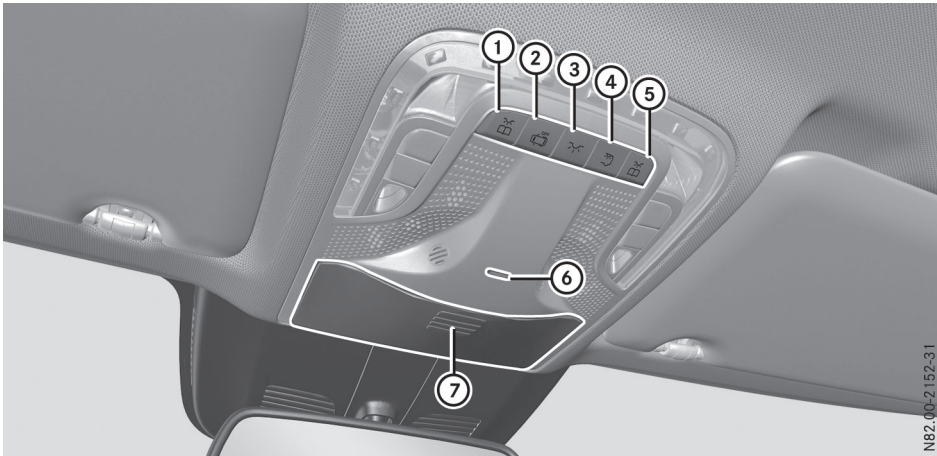

At a glance

Example: luxury overhead control panel

	Function	Page
①	Switches the left-hand reading lamp on/off	97
②	Switches the automatic interior lighting control on/off	97
③	Switches the front interior lighting on/off	98
④	Switches the rear interior lighting/cargo compartment lighting on/off	98





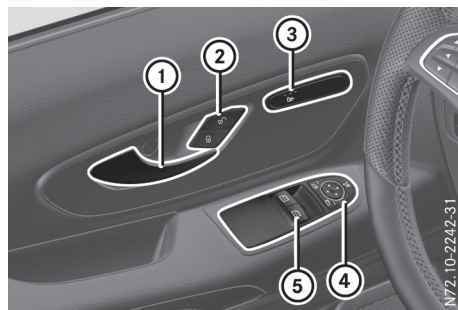

	Function	Page
⑤	Switches the right-hand reading lamp on/off	97
⑥	ATA indicator lamp	68
⑦	Eyeglasses compartment	238

The number and arrangement of the buttons is equipment-dependent.

Door control panel



	Function	Page
①	Opens the door	74

	Function	Page
②	 Seat heating	90
③	  Unlocks/locks the vehicle	73
④	   Adjusts the exterior mirrors electrically	92
⑤	 Opens/closes the front side windows	81

Useful information

This Operator's Manual describes all models as well as standard and optional equipment of your vehicle that were available at the time of going to print. Country-specific variations are possible. Note that your vehicle may not be equipped with all of the described functions. This also applies to systems and functions relevant to safety.

Read the information on qualified specialist workshops (▷ page 31).

Occupant safety

Restraint system introduction

The restraint system can reduce the risk of vehicle occupants coming into contact with parts of the vehicle's interior in the event of an accident. The restraint system can also reduce the forces to which vehicle occupants are subjected during an accident.

The restraint system comprises:

- Seat belt system
- Air bags
- Child restraint system
- Child seat securing systems

The components of the restraint system work in conjunction with each other. They can only deploy their protective function if, at all times, all vehicle occupants:

- have fastened their seat belts correctly (▷ page 48)
- have the seat and head restraint adjusted properly (▷ page 84)

As the driver, you also have to make sure that the steering wheel is adjusted correctly.

Observe the information relating to the correct driver's seat position (▷ page 84).

You also have to make sure that an air bag can inflate properly if deployed (▷ page 50).

An air bag supplements a correctly worn seat belt. As an additional safety device, the air bag increases the level of protection for vehicle occupants in the event of an accident. For example, if, in the event of an accident, the protection offered by the seat belt is sufficient, the air bags are not deployed. When an accident occurs, only the air bags that increase protection in that particular accident situation are deployed. How-

ever, seat belts and air bags generally do not protect against objects penetrating the vehicle from the outside.

Information on restraint system operation can be found under "Triggering of the Emergency Tensioning Devices and air bags" (▷ page 56).

See "Children in the vehicle" for information on children traveling with you in the vehicle as well as on child restraint systems (▷ page 58).

Important safety notes

WARNING

Modifications to the restraint system may cause it to no longer work as intended. The restraint system may then not perform its intended protective function and may fail in an accident or trigger unexpectedly, for example. This poses an increased risk of injury or even fatal injury.

Never modify parts of the restraint system. Never tamper with the wiring, the electronic components or their software.

If it is necessary to modify components of the restraint system to accommodate a person with disabilities, contact a Mercedes-Benz Commercial Van Center for details. USA only: contact our Mercedes-Benz Customer Assistance Center on 1-877-762-8267 for details.

Restraint system warning lamp

The functions of the restraint system are checked after the ignition is switched on and at regular intervals while the engine is running. Therefore, malfunctions can be detected in good time.

The  restraint system warning lamp on the instrument cluster lights up when the ignition is switched on. It goes out no later than a few seconds after the vehicle is started. The components of the restraint system are in operational readiness.

A malfunction has occurred if the  restraint system warning lamp:

- does not light up after the ignition is switched on
- does not go out after a few seconds with the engine running
- lights up again while the engine is running

WARNING

If the restraint system is malfunctioning, restraint system components may be triggered unintentionally or may not deploy as intended during an accident. This can affect for example the Emergency Tensioning Device or the air bag. This poses an increased risk of injury or even fatal injury.

Have the restraint system checked and repaired in a qualified specialist workshop as soon as possible.

PASSENGER AIR BAG OFF indicator lamp



PASSENGER AIR BAG OFF indicator lamp ① is part of the Occupant Classification System (OCS).

The PASSENGER AIR BAG OFF indicator lamp informs you about the status of the front-passenger front air bag.

If the PASSENGER AIR BAG OFF indicator lamp:

- **is lit:** the front-passenger front air bag is deactivated. It will then not be deployed in the event of an accident.
- **is not lit:** the front-passenger front air bag is enabled. If, in the event of an accident, all deployment criteria are met, the front-passenger front air bag is deployed.

Depending on the person in the front-passenger seat, the front-passenger front air bag must either be deactivated or enabled; see the following points. You must make sure of this both before and during a journey.

• Children in a child restraint system:

whether the front-passenger front air bag is enabled or deactivated depends on the installed child restraint system, and the age and size of the child. Therefore, be sure to observe the notes on the "Occupant Classification System (OCS)" (▷ page 52) and on "Children in the vehicle" (▷ page 58). There you will also find instructions on rearward and forward-facing child restraint systems on the front-passenger seat.

- **All other persons:** depending on the classification of the person in the front-passenger seat, the front-passenger front air bag is enabled or deactivated (▷ page 52). Be sure to observe the notes on "Seat belts" (▷ page 46) and "Air bags" (▷ page 49). There you can also find information on the correct seat position.

Seat belts

Introduction

Seat belts are the most effective means of restricting the movement of vehicle occupants in the event of an accident or the vehicle rolling over. This reduces the risk of vehicle occupants coming into contact with parts of the vehicle interior or being ejected from the vehicle. Furthermore, the seat belt helps to keep the vehicle occupant in the best position in relation to the air bag.

The seat belt system comprises:

- Seat belts
- Emergency Tensioning Devices for the front seat belts

The seat belt system also includes a seat belt force limiter for the relevant seat if the vehicle is equipped with a front air bag.

If the seat belt is pulled out of the belt outlet quickly or with a jerky movement, the belt retractor locks. The belt strap cannot be extracted any further.

The Emergency Tensioning Device tightens the seat belt in an accident, pulling the belt close against the body. However it does not pull the

vehicle occupant back in the direction of the backrest.

The Emergency Tensioning Device does not correct an incorrect seat position or the routing of an incorrectly fastened seat belt.

When triggered, a seat belt force limiter helps to reduce the force exerted by the seat belt on the vehicle occupant.

The seat belt force limiters for the front seats are synchronized with the front air bags, which absorb part of the deceleration force. This can reduce the force exerted on the vehicle occupants during an accident.

! If the front-passenger seat is unoccupied, do not insert the belt tongue into the buckle of the front-passenger seat. This may otherwise lead to the triggering of the Emergency Tensioning Device in the event of an accident, which will then need to be replaced.

Important safety notes

The use of seat belts and child restraint systems is required by law in:

- all 50 states
- the U.S. territories
- the District of Columbia
- all Canadian provinces

Even where this is not required by law, all vehicle occupants should correctly fasten their seat belts before starting the journey.

WARNING

If the seat belt is not worn correctly, it cannot perform its intended protective function. An incorrectly fastened seat belt can also cause injuries, for example, in the event of an accident or when braking or changing direction abruptly. This poses an increased risk of injury or even fatal injury.

Always ensure that all vehicle occupants have their seat belts fastened correctly and are sitting properly.

The components of the restraint system work in conjunction with each other. They can only deploy their protective function if, at all times, all vehicle occupants:

- have fastened their seat belts correctly (> page 48)
- have the seat and head restraint adjusted properly (> page 84)

WARNING

The seat belt does not offer the intended level of protection if you have not moved the backrest to an almost vertical position. When braking or in the event of an accident, you could slide underneath the seat belt and sustain abdomen or neck injuries, for example. This poses an increased risk of injury or even fatal injury.

Adjust the seat properly before beginning your journey. Always ensure that the backrest is in an almost vertical position and that the shoulder section of your seat belt is routed across the center of your shoulder.

WARNING

Persons less than 5 ft (1.50 m) tall cannot wear the seat belt correctly without an additional and suitable restraint system. If the seat belt is not worn correctly, it cannot perform its intended protective function. An incorrectly fastened seat belt can also cause injuries, for example, in the event of an accident or when braking or changing direction abruptly. This poses an increased risk of injury or even fatal injury.

For this reason, always secure persons under 5 ft (1.50 m) tall in suitable additional restraint systems.

If a child younger than twelve years old and under 5 ft (1.50 m) in height is traveling in the vehicle:

- always secure the child in a child restraint system suitable for this Mercedes-Benz vehicle. The child restraint system must be appropriate to the age, weight and size of the child
- always observe the instructions and safety notes on "Children in the vehicle" (> page 58) in addition to the child restraint

system manufacturer's installation and operating instructions

- always observe the instructions and safety notes on the "Occupant classification system (OCS)" (▷ page 52)

WARNING

The seat belts may not perform their intended protective function if:

- they are damaged, modified, extremely dirty, bleached or dyed
- the seat belt buckle is damaged or extremely dirty
- the Emergency Tensioning Devices, belt anchorages or inertia reels have been modified.

Seat belts may be damaged in an accident, although the damage may not be visible, e.g. due to splinters of glass. Modified or damaged seat belts may tear or fail, e.g. in an accident. Modified Emergency Tensioning Devices could accidentally trigger or fail to deploy when necessary. This poses an increased risk of injury or even fatal injury.

Never modify the seat belts, Emergency Tensioning Devices, belt anchorages and inertia reels. Make sure that the seat belts are undamaged, not worn out and clean. Following an accident, have the seat belts checked immediately at a qualified specialist workshop.

Only use seat belts that have been approved for your vehicle by Mercedes-Benz.

Proper use of the seat belts

Observe the safety notes on the seat belt (▷ page 47).

All vehicle occupants must be wearing the seat belt correctly before beginning the journey. Also make sure that all vehicle occupants are always wearing the seat belt correctly while the vehicle is in motion.

When fastening the seat belt, always make sure that:

- the seat belt buckle tongue is inserted only into the belt buckle belonging to that seat
- the seat belt is pulled tight across your body

Avoid wearing bulky clothing, e.g. a winter coat.

- the seat belt is not twisted
Only then can the forces which occur be distributed over the area of the belt.
- the shoulder section of the belt is routed across the center of your shoulder
The shoulder section of the seat belt should not touch your neck or be routed under your arm or behind your back. Where possible, adjust the seat belt to the appropriate height.
- the lap belt is taut and passes across your lap as low down as possible
The lap belt must always be routed across your hip joints and not across your abdomen. This applies particularly to pregnant women. If necessary, push the lap belt down to your hip joint and pull it tight using the shoulder section of the belt.

- the seat belt is not routed across sharp, pointed or fragile objects

If you have such items located on or in your clothing, e.g. pens, keys or eyeglasses, store these in a suitable place.

- only one person is using a seat belt
Infants and children must never travel sitting on the lap of a vehicle occupant. In the event of an accident, they could be crushed between the vehicle occupant and seat belt.
- objects are never secured with a seat belt if the seat belt is also being used by one of the vehicle's occupants

Also ensure that there are never objects between a person and the seat, e.g. cushions.

Seat belts are only intended to secure and restrain vehicle occupants. Always observe the "Loading guidelines" for securing objects, luggage or loads (▷ page 242).

Fastening and adjusting seat belts

Observe the safety notes on the seat belt (▷ page 47) and the notes on correct use of seat belts (▷ page 48).

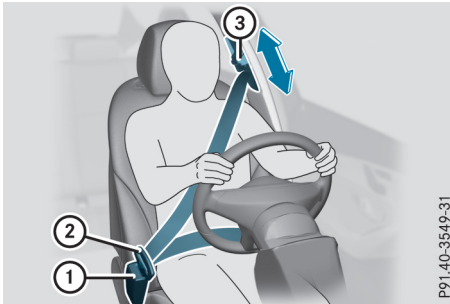

Basic illustration

- ▶ Adjust the seat (▷ page 84). The seat backrest must be in an almost upright position.
- ▶ Pull the seat belt smoothly from the belt outlet and engage belt tongue ② into belt buckle ①. The shoulder section of the seat belt must always be routed across the center of the shoulder. Adjust the belt outlet if necessary.
- ▶ If necessary, pull up on the shoulder section of the seat belt to tighten the belt across your body.

The shoulder section of the seat belt must always be routed across the center of the shoulder. Adjust the belt outlet if necessary.

- ▶ **To raise:** slide the belt outlet up. The belt outlet will engage in various positions.
- ▶ **To lower:** hold belt outlet release ③ and slide the belt outlet down.
- ▶ Let go of belt outlet release ③ in the desired position and make sure that the belt outlet engages.

All seat belts except the driver's seat belt are equipped with a special seat belt retractor to securely fasten child restraint systems in the vehicle. Further information can be found under "Special seat belt retractor" (▷ page 59).



Releasing seat belts

- ❗ Make sure that the seat belt is fully rolled up. Otherwise, the seat belt or belt tongue will be trapped in the door or in the seat mechanism. This could damage the door, the door trim panel and the seat belt. Damaged seat belts can no longer fulfill their protective function and must be replaced. Visit a qualified specialist workshop.

- ▶ Press the release button in the belt buckle, hold the belt tongue firmly and guide the belt back.

Belt warning for drivers and front passenger

The  seat belt warning lamp in the instrument cluster is a reminder that all vehicle occupants must wear their seat belts. It may light up continuously or flash. In addition, there may be a warning tone.

Regardless of whether the driver's seat belt has already been fastened, the  seat belt warning lamp lights up for six seconds each time the engine is started. If the front doors are closed and the driver's or front-passenger seat belt has not been fastened, the  seat belt warning lamp lights up again after the six seconds. As soon as the driver's and front-passenger seat belts are fastened or a front door is opened again, the  seat belt warning lamp goes out.

If the driver's seat belt is not fastened when the engine is started, an additional warning tone will sound. This warning tone stops after a maximum of six seconds or once the driver's seat belt is fastened.

If the vehicle's speed exceeds 15 mph (25 km/h) once and the driver's and front-passenger seat belts are not fastened, a warning tone sounds. A warning tone also sounds with increasing intensity for 60 seconds or until the driver or front passenger have fastened their seat belts.

If the driver or front passenger unfasten their seat belts during the journey, the seat belt warning is activated again.

Air bags

Introduction

The installation point of an air bag can be recognized by the AIRBAG marking.

An air bag complements the correctly fastened seat belt. It is no substitute for the seat belt. The air bag provides additional protection in applicable accident situations.

Not all air bags are deployed in an accident. The different air bag systems function independently from one another (▷ page 56).

However, no system available today can completely eliminate injuries and fatalities.

It is also not possible to rule out a risk of injury caused by an air bag due to the high speed at which the air bag must be deployed.

Important safety notes

WARNING

If you do not sit in the correct seat position, the air bag cannot protect as intended and could even cause additional injury when deployed. This poses an increased risk of injury or even fatal injury.

To avoid hazardous situations, always make sure that all of the vehicle's occupants:

- have fastened their seat belts correctly, including pregnant women
- are sitting correctly and maintain the greatest possible distance to the air bags
- follow the following instructions

Always make sure that there are no objects between the air bag and the vehicle's occupants.

- Adjust the seats properly before beginning your journey. Always make sure that the seat is in an almost upright position. The center of the head restraint must support the head at about eye level.
- Move the driver's and front-passenger seats as far back as possible. The driver's seat position must allow the vehicle to be driven safely.
- Only hold the steering wheel on the outside. This allows the air bag to be fully deployed.
- Always lean against the backrest while driving. Do not lean forward or lean against the door or side window. You may otherwise be in the deployment area of the air bags.
- Always keep your feet in the footwell in front of the seat. Do not put your feet on the dashboard, for example. Your feet may otherwise be in the deployment area of the air bag.
- For this reason, always secure persons less than 5 ft (1.50 m) tall in suitable restraint systems. Up to this height, the seat belt cannot be worn correctly.

If a child is traveling in your vehicle, also observe the following notes:

- Always secure children under twelve years of age and less than 5 ft (1.50 m) tall in suitable child restraint systems.
- Child restraint systems should be installed on the rear seats.
- Only secure a child in a rearward-facing child restraint system on the front-passenger seat when the front-passenger front air bag is deactivated. If the PASSENGER AIR BAG OFF indicator lamp is permanently lit, the front-passenger front air bag is deactivated (▷ page 46).
- Always observe the instructions and safety notes on the "Occupant Classification System (OCS)" (▷ page 52) and on "Children in the vehicle" (▷ page 58) in addition to the child restraint system manufacturer's installation and operating instructions.

Objects in the vehicle interior may prevent an air bag from functioning correctly. Before starting your journey and to avoid risks resulting from the speed of the air bag as it deploys, make sure that:

- there are no people, animals or objects between the vehicle occupants and an air bag
- there are no objects between the seat, door and B-pillar
- there are no hard objects, e.g. coat hangers, hanging on the grab handles or coat hooks
- no accessories, such as cup holders, are attached to the vehicle within the deployment area of an air bag, e.g. to doors or side windows
- no heavy, sharp-edged or fragile objects are in the pockets of your clothing. Store such objects in a suitable place

WARNING

If you modify the air bag cover or affix objects such as stickers to it, the air bag can no longer function correctly. There is an increased risk of injury.

Never modify an air bag cover or affix objects to it.

Vehicles with window curtain air bags for all seat rows:

⚠ WARNING

Sensors to control the air bags are located in the doors. Modifications or work not performed correctly to the doors or door paneling, as well as damaged doors, can lead to the function of the sensors being impaired. The air bags might therefore not function properly anymore. Consequently, the air bags cannot protect vehicle occupants as they are designed to do. There is an increased risk of injury.

Never modify the doors or parts of the doors. Always have work on the doors or door paneling carried out at a qualified specialist workshop.

Front air bags

! Do not place heavy objects on the front-passenger seat. This could cause the system to identify the seat as being occupied. In the event of an accident, the restraint systems on the front-passenger side may be triggered and have to be replaced.

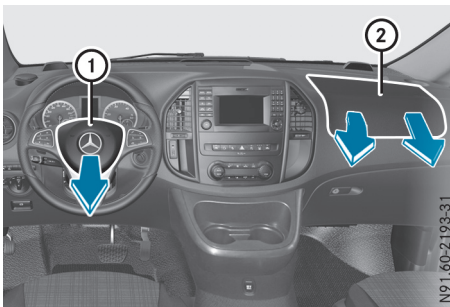

Driver's air bag ① deploys in front of the steering wheel. Front-passenger front air bag ② deploys in front of and above the glove box and the center console.

When deployed, the front air bags offer additional head and thorax protection for the occupants in the front seats.

The PASSENGER AIR BAG OFF indicator lamp informs you about the status of the front-passenger front air bag (▷ page 46).

The front-passenger front air bag will only deploy if:

- the system, based on the OCS weight sensor readings, detects that the front-passenger

seat is occupied (▷ page 52). The PASSENGER AIR BAG OFF indicator lamp is not lit (▷ page 53)

- the restraint system control unit predicts a high accident severity

Side impact air bags**⚠ WARNING**

Unsuitable seat covers can obstruct or prevent deployment of the air bags integrated into the seats. Consequently, the air bags cannot protect vehicle occupants as they are designed to do. In addition, the operation of the occupant classification system (OCS) could be adversely affected. This poses an increased risk of injury or even fatal injury.

You should only use seat covers that have been approved for the respective seat by Mercedes-Benz.



Side impact air bags ① deploy next to the outer bolster of the seat backrest.

When deployed, the side impact air bag offers additional thorax and pelvis protection. However, it does not protect the:

- Head
- Neck
- Arms

If the restraint system control unit detects a side impact, the side impact air bag is deployed on the side on which the impact occurs.

The side impact air bag on the front-passenger side deploys under the following conditions:

- the OCS system detects that the front-passenger seat is occupied or
- the seat belt buckle tongue is engaged in the belt buckle of the front-passenger seat

If the belt tongue is engaged in the belt buckle, the side impact air bag on the front-passenger side deploys if an appropriate accident situation occurs. In this case, deployment is independent of whether the front-passenger seat is occupied or not.

Window curtain air bags

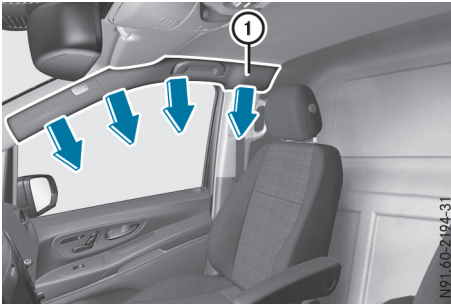

Example: window curtain air bag above the front door

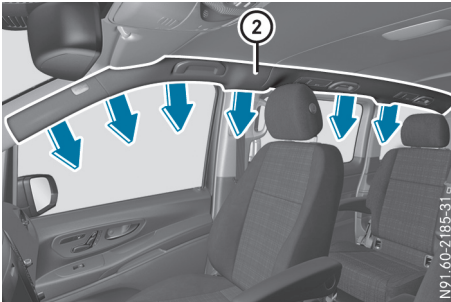

Example: window curtain air bag for all seat rows
Window curtain air bags ① or ② are integrated into the side of the roof frame. The window curtain air bags for all seat rows ② deploy in the area extending from the front door (A-pillar) to the rear side window (D-pillar).

When deployed, the window curtain air bag enhances the level of protection for the head. However, it does not protect the chest or arms. If the restraint system control unit detects a side impact, the window curtain air bag is deployed on the side on which the impact occurs.

If the system determines that they can offer additional protection to that provided by the seat belt, a window curtain air bag may be deployed in other accident situations (▷ page 56).

Occupant Classification System (OCS)

Introduction

The Occupant Classification System (OCS) categorizes the person in the front-passenger seat. Depending on that result, the front-passenger front air bag is either enabled or deactivated.

The system does not deactivate:

- the side impact air bag
- the window curtain air bag
- the Emergency Tensioning Devices

Conditions

To be classified correctly, the front passenger must sit:

- with the seat belt fastened correctly
- in an almost upright position with their back against the seat backrest
- with their feet resting on the floor, if possible

If the front passenger does not observe these conditions, OCS may produce a false classification, e.g. because the front passenger:

- transfers their weight by supporting themselves on a vehicle armrest
- sits in such a way that their weight is raised from the seat cushion

If it is absolutely necessary to install a child restraint system on the front-passenger seat, be sure to observe the correct positioning of the child restraint system. Never place objects under or behind the child restraint system, e.g. a cushion. The entire base of the child restraint system must always rest on the seat cushion of the front-passenger seat. The backrest of the forward-facing child restraint system must lie as flat as possible against the backrest of the front-passenger seat.

The child restraint system must not touch the roof or be subjected to a load by the head restraint. Adjust the angle of the seat backrest and the head restraint position accordingly.

Only then can OCS be guaranteed to function correctly. Always observe the child restraint system manufacturer's installation and operating instructions.

Occupant Classification System (OCS) operation



PASSENGER AIR BAG OFF indicator lamp ① shows you whether the front-passenger front air bag is deactivated.

- ▶ Turn the SmartKey to position ① or ② in the ignition lock.

The system carries out self-diagnostics.

The PASSENGER AIR BAG OFF indicator lamp must light up for approximately six seconds.

The PASSENGER AIR BAG OFF indicator lamp then displays the status of the front-passenger front air bag. If the status of the front-passenger front air bag changes while the vehicle is in motion, an air bag display message may appear in the instrument cluster:

- in vehicles without steering wheel buttons (> page 191)
- in vehicles with steering wheel buttons (> page 205)

When the front-passenger seat is occupied, always pay attention to the PASSENGER AIR BAG OFF indicator lamp. Be aware of the status of the front-passenger front air bag both before and during the journey.

If the PASSENGER AIR BAG OFF indicator lamp:

- **is lit:** the front-passenger front air bag is deactivated. It will then not be deployed in the event of an accident.
- **is not lit:** the front-passenger front air bag is enabled. If, in the event of an accident, all deployment criteria are met, the front-passenger front air bag is deployed.

WARNING

If the PASSENGER AIR BAG OFF indicator lamp is lit, the front-passenger front air bag is

disabled. It will not be deployed in the event of an accident and cannot perform its intended protective function. A person in the front-passenger seat could then, for example, come into contact with the vehicle's interior, especially if the person is sitting too close to the dashboard. This poses an increased risk of injury or even fatal injury.

When the front-passenger seat is occupied, always ensure that:

- the classification of the person in the front-passenger seat is correct and the front-passenger front air bag is enabled or disabled in accordance with the person in the front-passenger seat
- the front-passenger seat has been moved back as far back as possible.
- the person is seated correctly.

Make sure, both before and during the journey, that the status of the front-passenger front air bag is correct.

WARNING

If you secure a child in a child restraint system on the front-passenger seat and the PASSENGER AIR BAG OFF indicator lamp is off, the front-passenger front air bag can deploy in the event of an accident. The child could be struck by the air bag. This poses an increased risk of injury or even fatal injury.

Make sure that the front-passenger front air bag has been deactivated. The PASSENGER AIR BAG OFF indicator lamp must be lit.

NEVER use a rearward-facing child restraint on a seat protected by an ACTIVE FRONT AIR BAG in front of it; DEATH or SERIOUS INJURY to the child can occur.

 **WARNING**

If you secure a child in a forward-facing child restraint system on the front-passenger seat and you position the front-passenger seat too close to the dashboard, the child could, in the event of an accident:

- come into contact with the vehicle's interior if the PASSENGER AIR BAG OFF indicator lamp is lit, for example
- be struck by the air bag if the PASSENGER AIR BAG OFF indicator lamp is off

This poses an increased risk of injury or even fatal injury.

Move the front-passenger seat as far back as possible. Always make sure that the shoulder belt strap is correctly routed from the vehicle belt sash guide to the shoulder belt guide on the child restraint system. The shoulder belt strap must be routed forwards and downwards from the vehicle belt sash guide. If necessary, adjust the vehicle belt sash guide and the front-passenger seat accordingly. Always observe the child restraint system manufacturer's installation instructions.

If OCS determines that:

- The front-passenger seat is unoccupied, the PASSENGER AIR BAG OFF indicator lamp lights up after the system self-test and remains lit. This indicates that the front-passenger front air bag is deactivated.
- The front-passenger seat is occupied by a child of up to twelve months old, in a standard child restraint system, the PASSENGER AIR BAG OFF indicator lamp lights up after the system self-test and remains lit. This indicates that the front-passenger front air bag is deactivated.

But even in the case of a twelve-month-old child, in a standard child restraint system, the PASSENGER AIR BAG OFF indicator lamp can go out after the system self-test. This indicates that the front-passenger front air bag is activated. The result of the classification is dependent on, among other factors, the child restraint system and the child's stature. It is recommended that you install the child restraint system on a suitable rear seat.

- The front-passenger seat is occupied by a person of smaller stature (e.g. a teenager or small adult), the PASSENGER AIR BAG OFF indicator lamp lights up and remains lit after the system self-test depending on the result of the classification or, alternatively, goes out.
 - If the PASSENGER AIR BAG OFF indicator lamp is off, move the front-passenger seat as far back as possible. Alternatively, a person of smaller stature can sit on a rear seat.
 - If the PASSENGER AIR BAG OFF indicator lamp is lit, a person of smaller stature should not use the front-passenger seat.
- The front-passenger seat is occupied by an adult or a person of adult stature, the PASSENGER AIR BAG OFF indicator lamp goes out after the system self-test. This indicates that the front-passenger front air bag is activated.

If children are traveling in the vehicle, be sure to observe the notes on "Children in the vehicle" (> page 58).

When the occupant classification system (OCS) is malfunctioning, the red  restraint system warning lamp in the instrument cluster and the PASSENGER AIR BAG OFF indicator lamp light up simultaneously. The front-passenger front air bag is deactivated in this case and does not deploy during an accident. Have the Occupant Classification System (OCS) checked and repaired immediately at a qualified specialist workshop. Mercedes-Benz recommends that you visit a Mercedes-Benz Commercial Van Center.

If the front-passenger seat, the seat cover or the seat cushion are damaged, have the necessary repair work carried out at a qualified specialist workshop. Mercedes-Benz recommends that you visit a Mercedes-Benz Commercial Van Center.

For safety reasons, Mercedes-Benz recommends that you only use seat accessories that have been approved by Mercedes-Benz.

If the driver's air bag deploys, this does not mean that the front-passenger front air bag will also deploy. The Occupant Classification System (OCS) categorizes the occupant on the front-passenger seat. Depending on that result, the front-passenger front air bag is either enabled or deactivated.

System self-test

DANGER

If the PASSENGER AIR BAG OFF indicator lamp does not light up during the system self-test, then the system is malfunctioning. The front-passenger front air bag might be triggered unintentionally or might not be triggered at all in the event of an accident with high deceleration. This poses an increased risk of injury or even fatal injury.

In this case the front-passenger seat may not be used. Do not install a child restraint system on the front-passenger seat. Have the Occupant Classification System (OCS) checked and repaired immediately at a qualified specialist workshop.

WARNING

If the PASSENGER AIR BAG OFF indicator lamp remains lit after the system self-test, the front-passenger front air bag is disabled. It will not be deployed in the event of an accident. In this case, the front-passenger front air bag cannot perform its intended protective function, e.g. when a person is seated in the front-passenger seat.

That person could, for example, come into contact with the vehicle's interior, especially if the person is sitting too close to the dashboard. This poses an increased risk of injury or even fatal injury.

When the front-passenger seat is occupied, always ensure that:

- the classification of the person in the front-passenger seat is correct and the front-passenger front air bag is enabled or disabled in accordance with the person in the front-passenger seat
- the person is seated properly with a correctly fastened seatbelt
- the front-passenger seat has been moved as far back as possible

If the PASSENGER AIR BAG OFF indicator lamp remains lit when it should not, the front-passenger seat may not be used. Do not install a child restraint system on the front-passenger seat. Have the Occupant Classification System (OCS) checked and repaired immediately at a qualified specialist workshop.

WARNING

Objects between the seat surface and the child restraint system could affect OCS operation. This could result in the front-passenger air bag not functioning as intended during an accident. This poses an increased risk of injury or even fatal injury.

Do not place any objects between the seat surface and the child restraint system. The entire base of the child restraint system must always rest on the seat cushion of the front-passenger seat. The backrest of the forward-facing child restraint system must, as far as possible, be resting on the backrest of the front-passenger seat. Always comply with the child restraint system manufacturer's installation instructions.

After the system self-test, the PASSENGER AIR BAG OFF indicator lamp then shows the status of the front-passenger front air bag (> page 53). For more information about the OCS, see "Problems with the Occupant Classification System" (> page 56).

Problems with the Occupant Classification System (OCS)

Be sure to observe the notes on "System self-test" (▷ page 55).

Problem	Possible causes/consequences and ► Solutions
The PASSENGER AIR BAG OFF indicator lamp lights up and remains lit, even though the front-passenger seat is occupied by an adult or a person of a stature corresponding to that of an adult.	<p>The classification of the person on the front-passenger seat is incorrect.</p> <ul style="list-style-type: none"> ► Make sure the conditions for a correct classification of the person on the front-passenger seat are met (▷ page 52). ► If the PASSENGER AIR BAG OFF indicator lamp remains lit, the front-passenger seat may not be used. ► Have OCS checked as soon as possible at a Mercedes-Benz Commercial Van Center.
<p>The PASSENGER AIR BAG OFF indicator lamp does not light up and/or does not stay on.</p> <p>The front-passenger seat is:</p> <ul style="list-style-type: none"> • unoccupied • occupied with the weight of a child up to twelve months old in a child restraint system 	<p>OCS is malfunctioning.</p> <ul style="list-style-type: none"> ► Make sure there is nothing between the seat cushion and the child seat. ► Make sure that the entire base of the child restraint system rests on the seat cushion of the front-passenger seat. The backrest of the forward-facing child restraint system must lie as flat as possible against the backrest of the front-passenger seat. If necessary, adjust the position of the front-passenger seat. ► When installing the child restraint system, make sure that the seat belt is tight. Do not pull the seat belt tight using the front-passenger seat adjustment. This could result in the seat belt and the child restraint system being pulled too tightly. ► Check for correct installation of the child restraint system. Make sure that the head restraint does not apply a load to the child restraint system. If necessary, adjust the head restraint accordingly. ► Make sure that no objects are applying additional weight onto the seat. ► If the PASSENGER AIR BAG OFF indicator lamp remains off, do not install a child restraint system on the front-passenger seat. It is recommended that you install the child restraint system on a suitable rear seat. ► Have OCS checked as soon as possible at a Mercedes-Benz Commercial Van Center.

Deployment of Emergency Tensioning Devices and air bags

Important safety notes

WARNING

The air bag parts are hot after an air bag has been deployed. There is a risk of injury.

Do not touch the air bag parts. Have a deployed air bag replaced at a qualified specialist workshop as soon as possible.

WARNING

A deployed air bag no longer offers any protection and cannot provide the intended protection in an accident. There is an increased risk of injury.

Have the vehicle towed to a qualified specialist workshop in order to have a deployed air bag replaced.

It is important for your safety and that of your passenger to have deployed air bags replaced and to have any malfunctioning air bags repaired. This will help to make sure the air bags continue to perform their protective function for the vehicle occupants in the event of a crash.

WARNING

Emergency Tensioning Devices that have deployed pyrotechnically are no longer operational and are unable to perform their intended protective function. This poses an increased risk of injury or even fatal injury. Have pyrotechnically triggered Emergency Tensioning Devices replaced immediately at a qualified specialist workshop.

If Emergency Tensioning Devices are triggered or air bags are deployed, you will hear a bang, and a small amount of powder may also be released. The  restraint system warning lamp lights up.

Only in rare cases will the bang affect your hearing. The powder that is released generally does not constitute a health hazard, but it may cause short-term breathing difficulties in people with asthma or other respiratory problems. Provided it is safe to do so, you should leave the vehicle immediately or open the window in order to prevent breathing difficulties.

Air bags and pyrotechnic Emergency Tensioning Devices (ETDs) contain perchlorate material, which may require special handling and regard for the environment. National guidelines must be observed during disposal. In California, see www.dtsc.ca.gov/HazardousWaste/Perchlorate/index.cfm.

Method of operation

During the first stage of a collision, the restraint system control unit evaluates important physical data relating to vehicle deceleration or acceleration, such as:

- duration
- direction
- intensity

Based on the evaluation of this data, the restraint system control unit triggers the Emergency Tensioning Devices during a frontal or rear collision.

An Emergency Tensioning Device can only be triggered, if:

- the ignition is switched on
- the components of the restraint system are operational. You can find further information under "Restraint system warning lamp" (> page 45)

- the seat belt buckle tongue has engaged in the belt buckle of the respective front seat

If the restraint system control unit detects a more severe accident, further components of the restraint system are activated independently of each other in certain frontal collision situations:

- Front air bags
- Window curtain air bag, if the system determines that deployment can offer additional protection to that provided by the seat belt

The front-passenger front air bag is activated or deactivated depending on the person on the front-passenger seat. The front-passenger front air bag can only deploy in an accident if the PASSENGER AIR BAG OFF indicator lamp is off. Observe the information on the PASSENGER AIR BAG OFF indicator lamp (> page 46).

Your vehicle has two-stage front air bags. In the first deployment stage, the front air bag is filled with propellant gas. The front air bag is fully deployed with the maximum amount of propellant gas if a second deployment threshold is reached within a few milliseconds.

The activation threshold of the Emergency Tensioning Devices and the air bags is determined by evaluating the rate of vehicle deceleration or acceleration which occurs at various points in the vehicle. This process is pre-emptive in nature. Deployment should take place in good time at the start of the collision.

The rate of vehicle deceleration or acceleration and the direction of the force are essentially determined by:

- the distribution of forces during the collision
- the collision angle
- the deformation characteristics of the vehicle
- the characteristics of the object with which the vehicle has collided

Factors which can only be seen and measured after a collision has occurred do not play a deci-

sive role in the deployment of an air bag. Nor do they provide an indication of air bag deployment.

The vehicle can be deformed considerably, without an air bag being deployed. This is the case if only parts which are relatively easily deformed are affected and the rate of deceleration is not high. Conversely, air bags may be deployed even though the vehicle suffers only minor deformation. This is the case if, for example, very rigid vehicle parts such as longitudinal body members are hit, and sufficient deceleration occurs as a result.

If the restraint system control unit detects a side impact or if the vehicle rolls over, the applicable components of the restraint system are activated independently of each other depending on the apparent type of accident.

- Side impact air bag and pelvis air bag on the side on which an impact occurs, independent from the Emergency Tensioning Device and seat belt usage

The side impact air bag on the front-passenger side deploys under the following conditions:

- the OCS system detects that the front-passenger seat is occupied or
- the seat belt buckle tongue is engaged in the belt buckle of the front-passenger seat
- Window curtain air bag on the side of impact, independently of the use of the seat belt and independently of whether the front-passenger seat is occupied
- Emergency Tensioning Devices, if the system determines that deployment can offer additional protection in this situation
- Window curtain air bags on the driver's and front-passenger side in certain situations when the vehicle rolls over, if the system determines that deployment can offer additional protection to that provided by the seat belt

i Not all air bags are deployed in an accident. The different air bag systems work independently of each other.

How the air bag system works is determined by the severity of the accident detected, especially the vehicle deceleration or acceleration and the apparent type of accident:

- Frontal collision
- Side impact
- Rollover

Automatic measures after an accident

Immediately after an accident, the following measures are implemented, depending on the type and severity of the impact:

- the hazard warning lamps are activated
- the emergency lighting in the interior is activated
- the vehicle doors are unlocked
- the front side windows are lowered
- air-recirculation mode is activated
- climate control is switched off
- the engine is switched off and the fuel supply is cut off

Children in the vehicle

Important safety notes

Accident statistics show that children secured in the rear seats are safer than children secured in the front-passenger seat. For this reason, Mercedes-Benz strongly advises that you install a child restraint system on a rear seat. Children are generally better protected there.

If a child younger than twelve years old and under 5 ft (1.50 m) in height is traveling in the vehicle:

- always secure the child in a child restraint system suitable for Mercedes-Benz vehicles. The child restraint system must be appropriate to the age, weight and size of the child
- be sure to observe the instructions and safety notes in this section in addition to the child restraint system manufacturer's installation instructions
- be sure to observe the instructions and safety notes on the "Occupant classification system (OCS)" (▷ page 52)

⚠ WARNING

If you leave children unsupervised in the vehicle, they could set it in motion by, for example:

- release the parking brake.
- shift the automatic transmission out of the parking position **P**.
- start the engine.

In addition, they may operate vehicle equipment and become trapped. There is a risk of an accident and injury.

When leaving the vehicle, always take the SmartKey with you and lock the vehicle. Never leave children unsupervised in the vehicle.

 **WARNING**

If persons, particularly children are subjected to prolonged exposure to extreme heat or cold, there is a risk of injury, possibly even fatal. Never leave children unattended in the vehicle.

 **WARNING**

If the child restraint system is subjected to direct sunlight, parts may get very hot. Children may burn themselves on these parts, particularly on the metal parts of the child restraint system. There is a risk of injury.

If you leave the vehicle, taking the child with you, always ensure that the child restraint system is not exposed to direct sunlight. Protect it with a blanket, for example. If the child restraint system has been exposed to direct sunlight, let it cool down before securing the child in it. Never leave children unattended in the vehicle.

Always ensure that all vehicle occupants have their seat belts fastened correctly and are sitting properly. Particular attention must be paid to children.

Observe the safety notes on the seat belt (▷ page 47) and the notes on correct use of seat belts (▷ page 48).

A booster seat may be necessary to achieve proper seat belt positioning for children over 41 lbs (18 kg) until they reach a height where a three-point seat belt can be properly fastened without a booster seat.

Special seat belt retractor

 **WARNING**

If the seat belt is released while driving, the child restraint system will no longer be

secured properly. The special seat belt retractor is disabled and the inertia reel draws in a portion of the seat belt. The seat belt cannot be immediately refastened. There is an increased risk of injury, possibly even fatal. Stop the vehicle immediately, paying attention to road and traffic conditions. Reactivate the special seat belt retractor and secure the child restraint system properly.

All seat belts in the vehicle, except the driver's seat belt, are equipped with a special seat belt retractor. When activated, the special seat belt retractor ensures that the seat belt cannot slacken once the child seat is secured.

Installing a child restraint system:

- ▶ Make sure you observe the child restraint system manufacturer's installation instructions.
- ▶ Pull the seat belt smoothly from the belt outlet.
- ▶ Engage seat belt tongue in belt buckle.

Activating the special seat belt retractor:

- ▶ Pull the seat belt out fully and let the inertia reel retract it again. While the seat belt is retracting, you should hear a ratcheting sound. The special seat belt retractor is enabled.
- ▶ Push the child restraint system down so that the seat belt is tight and does not loosen.

Removing the child restraint system and deactivating the special seat belt retractor:

- ▶ Make sure you observe the child restraint system manufacturer's installation instructions.
- ▶ Press the release button of the seat belt buckle and guide the seat belt tongue back towards the belt sash guide. The special seat belt retractor is deactivated.

Child restraint system

The use of seat belts and child restraint systems is required by law in:

- all 50 states
- the U.S. territories
- the District of Columbia
- all Canadian provinces

You can obtain further information about the correct child restraint system from any Mercedes-Benz Commercial Van Center.

 **WARNING**

If the child restraint system is installed incorrectly on a suitable seat, it cannot protect as intended. The child cannot then be restrained in the event of an accident, heavy braking or sudden changes of direction. There is an increased risk of injury, possibly even fatal.

Make sure that you observe the child restraint system manufacturer's installation instructions and the notes on use. Please ensure, that the base of the child restraint system is always resting completely on the seat cushion. Never place objects, e.g. cushions, under or behind the child restraint system. Only use child restraint systems with the original cover designed for them. Only replace damaged covers with genuine covers.

 **WARNING**

If a rearward facing child restraint system is installed in the direction of travel by mistake, it cannot protect as intended. This is the case if, for instance, you install a rearward-facing child restraint system on a rear seat opposite to the direction of travel. In the event of an accident, a child might not be restrained correctly. This poses an increased risk of injury or even fatal injury.

Always install the rear seat in the direction of travel before you install the rearward facing child restraint system.

 **WARNING**

If the child restraint system is installed incorrectly or is not secured, it can come loose in the event of an accident, heavy braking or a sudden change in direction. The child restraint system could be thrown about, striking vehicle occupants. There is an increased risk of injury, possibly even fatal.

Always install child restraint systems properly, even if they are not being used. Make

sure that you observe the child restraint system manufacturer's installation instructions.

You will find further information on stowing objects, luggage or loads under "Loading guidelines" (▷ page 242).

 **WARNING**

Child restraint systems or their securing systems which have been damaged or subjected to a load in an accident can no longer protect as intended. The child cannot then be restrained in the event of an accident, heavy braking or sudden changes of direction. There is an increased risk of injury, possibly even fatal.

Replace child restraint systems which have been damaged or subjected to a load in an accident as soon as possible. Have the securing systems on the child restraint system checked at a qualified specialist workshop, before you install a child restraint system again.

The securing systems of child restraint systems are:

- the seat belt system
- the LATCH-type (ISOFIX) securing rings
- the Top Tether anchorages

If it is absolutely necessary to carry a child on the front-passenger seat, be sure to observe the information on the "Occupant Classification System (OCS)" (▷ page 52). There you will also find information on deactivating the front-passenger front air bag.

All child restraint systems must meet the following standards:

- U.S. Federal Motor Vehicle Safety Standards 213 and 225
- Canadian Motor Vehicle Safety Standards 213 and 210.2

Confirmation that the child restraint system corresponds to the standards can be found on an instruction label on the child restraint system. This confirmation can also be found in the installation instructions that are included with the child restraint system.

Observe the warning labels in the vehicle interior and on the child restraint system.

LATCH-type (ISOFIX) child seat securing system

WARNING

LATCH-type (ISOFIX) child restraint systems do not offer sufficient protection for children whose weight combined with the child restraint system is greater than 65 lbs (29 kg) and who are secured using the safety belt integrated in the child restraint system. In the event of an accident, a child might not be restrained correctly. This poses an increased risk of injury or even fatal injury.

If the child and the child restraint system together weigh more than 65 lbs (29 kg), only use LATCH-type (ISOFIX) child restraint systems with which the child is also secured with the vehicle seat belt. Also secure the child restraint system with the Top Tether belt, if available.

Always comply with the manufacturer's installation and operating instructions for the child restraint system used.

Before installing a child seat, move the rear seat backrest to an upright position. Do not adjust the backrest of a seat with a LATCH-type (ISOFIX) child restraint system installed.

Before every trip, make sure that the LATCH-type (ISOFIX) child restraint system is engaged correctly in both LATCH-type (ISOFIX) securing rings

-  When fitting the child restraint system in vehicles with a rear bench seat, make sure that the seat belt for the center seat does not get trapped. Otherwise, the seat belt could be damaged.

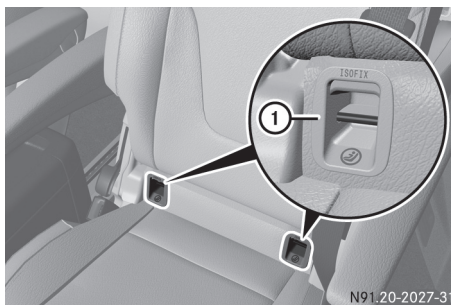

- ① LATCH-type (ISOFIX) securing rings (basic illustration)

- Install the LATCH-type (ISOFIX) child restraint system on both LATCH-type (ISOFIX) securing rings ①.

ISOFIX is a standardized securing system for specially designed child restraint systems on certain rear seats. LATCH-type (ISOFIX) securing rings ① for a LATCH-type (ISOFIX) child restraint system are installed between the seat cushion and the seat backrest.

Non-LATCH-type (ISOFIX) child seats may also be used and can be installed using the vehicle's seat belt system. Install the child seat according to the manufacturer's instructions.

Top Tether

Introduction

Top Tether provides an additional connection between the child restraint system secured with a LATCH-type (ISOFIX) system and the vehicle. This helps reduce the risk of injury even further. If the child restraint system is equipped with a Top Tether belt, this should always be used.

Top Tether anchorages

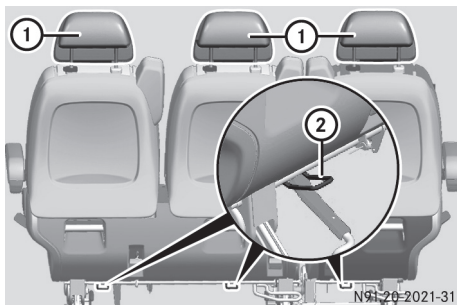

Example: rear bench seat

Top Tether anchorage ② is located at the bottom of the rear side of the rear seat on the cross brace between the seat or bench seat legs.

- ▶ Move head restraint ① up.
- ▶ Install the LATCH-type (ISOFIX) child restraint system with Top Tether. Always comply with the child restraint system manufacturer's installation instructions when doing so.

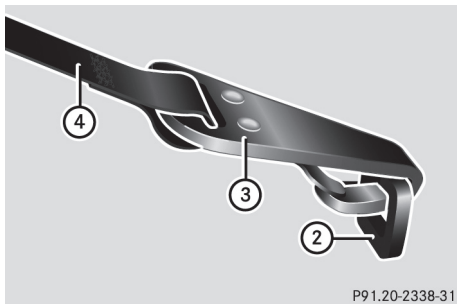

- ▶ Route Top Tether belt ④ under head restraint ① between the two head restraint bars.
- ▶ Hook Top Tether hook ③ of Top Tether belt ④ into Top Tether anchorage ②. Make sure that Top Tether belt ④ is not twisted.
- ▶ Tension Top Tether belt ④. Always comply with the child restraint system manufacturer's installation instructions when doing so.
- ▶ Move head restraint ① back down again slightly if necessary (▷ page 89). Make sure that you do not interfere with the correct routing of Top Tether belt ④.

Child restraint system on the front-passenger seat

General notes

Accident statistics show that children secured in the rear seats are safer than children secured in the front-passenger seat. For this reason, Mercedes-Benz strongly advises that you install the child restraint system on a rear seat.

If it is absolutely necessary to install a child restraint system on the front-passenger seat, always observe the instructions and safety notes on the "Occupant Classification System (OCS)" (▷ page 52).

You can thus avoid the risks that could arise as a result of:

- an incorrectly categorized person in the front-passenger seat
- the unintentional deactivation of the front-passenger front air bag
- the unsuitable positioning of the child restraint system, e.g. too close to the dashboard

Rearward-facing child restraint system

If it is absolutely necessary to install a rearward-facing child restraint system on the front-passenger seat, always make sure that the front-passenger front air bag is deactivated. Only if the PASSENGER AIR BAG OFF indicator lamp is permanently lit (▷ page 46) is the front-passenger front air bag deactivated.

Always observe the child restraint system manufacturer's installation and operating instructions.

Forward-facing child restraint system

If it is absolutely necessary to install a forward-facing child restraint system on the front-passenger seat, always move the front-passenger seat as far back as possible. The entire base of the child restraint system must always rest on the seat cushion of the front-passenger seat. The backrest of the child restraint system must lie as flat as possible against the backrest of the front-passenger seat. The child restraint system must not touch the roof or be subjected to a load by the head restraint. Adjust the angle of the seat backrest and the head restraint position accordingly. Always make sure that the shoulder belt strap is

correctly routed from the vehicle belt outlet to the shoulder belt guide on the child restraint system. The shoulder belt strap must be routed forward and down from the vehicle belt outlet. If necessary, adjust the vehicle belt outlet and the front-passenger seat accordingly.

Always observe the child restraint system manufacturer's installation and operating instructions.

Override features/Child-proof locks

Important safety notes

WARNING

If children are traveling in the vehicle, they could:

- open doors, thus endangering other people or road users
- exit the vehicle and be caught by oncoming traffic
- operate vehicle equipment and become trapped

There is a risk of an accident and injury.

Always activate the child-proof locks and override feature if children are traveling in the vehicle. When leaving the vehicle, always take the key with you and lock the vehicle. Never leave children unattended in the vehicle.

Child-proof lock/override feature for:

- Sliding doors (▷ page 63)

WARNING

If you leave children unsupervised in the vehicle, they could set it in motion by, for example:

- release the parking brake.
- shift the automatic transmission out of the parking position **P**.
- start the engine.

In addition, they may operate vehicle equipment and become trapped. There is a risk of an accident and injury.

When leaving the vehicle, always take the SmartKey with you and lock the vehicle. Never leave children unsupervised in the vehicle.

WARNING

If persons, particularly children are subjected to prolonged exposure to extreme heat or cold, there is a risk of injury, possibly even fatal. Never leave children unattended in the vehicle.

WARNING

If the child restraint system is subjected to direct sunlight, parts may get very hot. Children may burn themselves on these parts, particularly on the metal parts of the child restraint system. There is a risk of injury.

If you leave the vehicle, taking the child with you, always ensure that the child restraint system is not exposed to direct sunlight. Protect it with a blanket, for example. If the child restraint system has been exposed to direct sunlight, let it cool down before securing the child in it. Never leave children unattended in the vehicle.

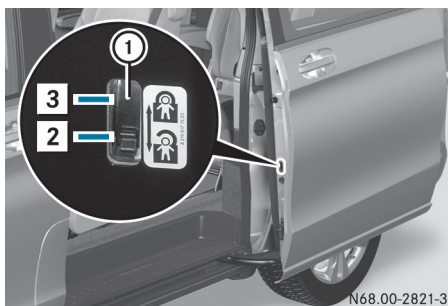

Child-proof lock for sliding door



Sliding door (example: left side of the vehicle)

- ① Child safety bolt
- ② Sliding door released
- ③ Sliding door secured – then make sure that the child-proof locks are working properly.

You can secure each sliding door individually with the child-proof locks on the sliding doors. A secured sliding door cannot be opened from inside the vehicle. When the vehicle is unlocked, the sliding door can be opened from the outside. If the electric sliding door is secured, only the sliding door rear controls are deactivated. If the electric sliding door is unlocked, you can open

the electric sliding door using the corresponding  or  sliding door button in the center console (▷ page 77).

Pets in the vehicle

WARNING

If you leave animals unattended or unsecured in the vehicle, they could press buttons or switches, for example.

As a result, they could:

- activate vehicle equipment and become trapped, for example
- activate or deactivate systems, thereby endangering other road users

Unsecured animals could also be flung around the vehicle in the event of an accident or sudden steering or braking, thereby injuring vehicle occupants. There is a risk of an accident and injury.

Never leave animals unattended in the vehicle. Always secure animals properly during the journey, e.g. use a suitable animal transport box.

Driving safety systems

Overview

In this section, you will find information about the following driving safety systems:

- EBD (**E**lectronic **B**rake **F**orce **D**istribution)
- ABS (**A**nti-**l**ock **B**raking **S**ystem)
- BAS (**B**rake **A**ssist **S**ystem)
- ESP® (**E**lectronic **S**tability **P**rogram)

Important safety notes

If you fail to adapt your driving style or if you are inattentive, the driving safety systems can neither reduce the risk of accident nor override the laws of physics. Driving safety systems are merely aids designed to assist driving. You are responsible for the distance to the vehicle in front, for vehicle speed, braking in good time and for staying in your lane. Always adapt your

driving style to the prevailing road and weather conditions and maintain a sufficient, safe distance from other road users. Drive carefully.

Please note that the driving safety systems described only work optimally when:

- there is adequate contact between the tires and the road surface
- you use winter tires (M+S tires), with snow chains if necessary, when the road conditions are wintry
- the speed information determined by the vehicle is within the legally prescribed display accuracy

Pay particular attention to the information regarding tires, tire tread and winter operation under "Wheels and tires" (▷ page 277).

ABS (Anti-lock Braking System)

General notes

ABS regulates brake pressure in such a way that the wheels do not lock when you brake. This allows you to continue steering the vehicle when braking.

The  warning lamp in the instrument cluster lights up when the ignition is switched on. The lamp goes out when the engine starts running.

Important safety notes

Observe the important safety guidelines for the driving safety system (▷ page 64).

ABS works from a speed of about 5 mph (8 km/h), regardless of road-surface conditions. ABS works on slippery surfaces, even when you only brake gently.

WARNING

If ABS is faulty, the wheels could lock when braking. The steerability and braking characteristics may be severely impaired. Additionally, further driving safety systems are deactivated. There is an increased danger of skidding and accidents.

Drive on carefully. Have ABS checked immediately at a qualified specialist workshop.

If ABS is malfunctioning, the  warning lamp (▷ page 222) lights up while the engine is running and the display shows a message:

- on vehicles without steering wheel buttons (▷ page 190)
- on vehicles with steering wheel buttons (▷ page 204)

BAS, Hill Start Assist and ESP[®] and its driving safety systems and other driving systems also fail. Observe the notes on the  warning lamp and the display messages.

Braking

If ABS intervenes when braking, you will feel a pulsating in the brake pedal.

The pulsating brake pedal can be an indication of hazardous road conditions and functions as a reminder to take extra care while driving.

- ▶ **If ABS intervenes:** continue to depress the brake pedal with force until the braking situation is over.
- ▶ **To make a full brake application:** depress the brake pedal with full force.

BAS (Brake Assist System)

General notes

BAS operates in emergency braking situations. If you depress the brake pedal quickly, BAS automatically boosts the braking force, thus shortening the stopping distance.

Important safety notes

Observe the important safety guidelines for the driving safety system (▷ page 64).

WARNING

If BAS is malfunctioning, the braking distance in an emergency braking situation is increased. There is a risk of an accident.

In an emergency braking situation, depress the brake pedal with full force. ABS prevents the wheels from locking.

If BAS is malfunctioning, the  warning lamp lights up while the engine is running (▷ page 222) and the display shows a message:

- on vehicles without steering wheel buttons (▷ page 194)
- on vehicles with steering wheel buttons (▷ page 208)

Brakes

- ▶ Keep the brake pedal firmly depressed until the emergency braking situation is over. ABS prevents the wheels from locking.

The brakes will function as usual once you release the brake pedal. BAS is deactivated.

EBD (electronic brake force distribution)

General notes

EBD monitors and controls the brake pressure to the rear wheels. This enables EBD to improve handling during braking.

Important safety notes

Observe the important safety guidelines for the driving safety system (▷ page 64).

WARNING

If EBD is malfunctioning, the rear wheels can lock, e.g. under full braking. This increases the risk of skidding and an accident.

You should therefore adapt your driving style to the different handling characteristics. Have the brake system checked at a qualified specialist workshop.

If EBD is malfunctioning, the  warning lamp (▷ page 221) lights up while the engine is running and the display shows a message.

- on vehicles without steering wheel buttons (▷ page 193)
- on vehicles with steering wheel buttons (▷ page 207)

Other driving systems and driving safety systems then also fail.

ESP[®] (Electronic Stability Program)

General notes

ESP[®] monitors driving stability and detects a tendency of the vehicle to understeer or oversteer (skidding) in good time. If ESP[®] detects that the vehicle is deviating from the direction desired by the driver, one or more wheels are braked to stabilize the vehicle. The engine out-

put is also modified to keep the vehicle on the desired course within physical limits. ESP® can also stabilize the vehicle during braking.

ESP® also monitors traction, i.e. power transmission between the tires and the road surface. The integrated traction control supports you when pulling away or accelerating on wet, slippery or slick roads. Should the drive wheels spin, traction control brakes them individually. In addition, greater drive torque is transmitted to the wheel or wheels with traction. If traction on the road surface is not sufficient, even ESP® will not allow you to pull away without difficulty. The type of tires and total weight of the vehicle as well as the gradient of the road also play a crucial role. Traction control remains active if you deactivate ESP®.

If the  warning lamp in the instrument cluster goes out before beginning the journey, ESP® is automatically active.

The  warning lamp in the instrument cluster flashes when ESP® intervenes:

- ▶ Do not deactivate ESP® under any circumstances.
- ▶ when driving off, apply as little throttle as possible.
- ▶ adapt your speed and driving style to the prevailing road conditions.

Important safety notes

Observe the important safety guidelines for the driving safety system (▷ page 64).

WARNING

If ESP® is malfunctioning it will not provide any vehicle stabilization. There is an increased risk of skidding or of an accident.

Exercise caution when continuing to drive.

Have ESP® checked at a qualified specialist workshop.

- ❗ Do not run the vehicle on a roller dynamometer (e.g. for performance tests). If you must operate the vehicle on a roller dynamometer, please consult a qualified specialist workshop in advance. You could otherwise damage the drive train or the brake system.

If ESP® is malfunctioning, the  warning lamp (▷ page 222) lights up continuously while

the engine is running and the display shows a message.

- on vehicles without steering wheel buttons (▷ page 194)
- on vehicles with steering wheel buttons (▷ page 208)

ESP® is deactivated if the  warning lamp in the instrument cluster is lit when the engine is running.

Only use wheels with the recommended tire sizes. Only then will ESP® function properly.

Deactivating or activating ESP®

WARNING

If you deactivate ESP®, ESP® no longer stabilizes the vehicle. There is an increased risk of skidding and an accident.



Only deactivate ESP® in the situations described in the following.

It may be best to deactivate ESP® in the following situations:

- when using snow chains
- in deep snow
- on sand or gravel

Activate ESP® as soon as the situations described above no longer apply. Otherwise, ESP® assistance for stabilizing the vehicle will remain significantly reduced, even if the vehicle starts to skid.

If you deactivate ESP®:



- the  warning lamp in the instrument cluster lights up
- the  warning lamp in the instrument cluster flashes if the wheels are spinning
- ESP® assistance for stabilizing the vehicle in the lower speed range up to approximately 37 mph (60 km/h) is significantly reduced
- engine torque is no longer limited and the drive wheels are able to spin. The spinning of the wheels results in a cutting action for better traction on loose surfaces
- traction control is still activated
- ESP® still provides support when you brake

Depending on the equipment in the vehicle, you can activate or deactivate ESP® when the engine is running by using the  button or by using the on-board computer:

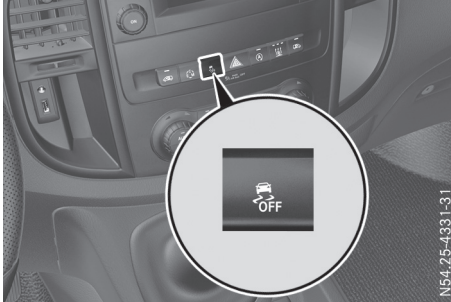
- on vehicles without steering wheel buttons (> page 174)
- on vehicles with steering wheel buttons (> page 184)



 button (equipment-dependent)

► **To activate/deactivate:** when the engine is running, press the  button. The  warning lamp in the instrument cluster lights up when ESP® is deactivated.

Trailer stabilization

Observe the important safety guidelines for the driving safety system (> page 64).

WARNING

If road and weather conditions are poor, trailer stabilization will not be able to prevent the vehicle/trailer combination from swerving. Trailers with a high center of gravity can tip over before ESP® can detect this. There is a risk of an accident.

Always adapt your driving style to the prevailing road and weather conditions.

ESP® trailer stabilization counteracts critical driving situations in good time and thereby provides considerable assistance when driving with a trailer. Trailer stabilization is part of ESP®.

If the sensor system and evaluation logic detect trailer swinging movements, ESP® trailer stabilization firstly brakes individual vehicle wheels in a targeted manner. It thus counteracts swinging movements. If the swinging movements do not stop, the vehicle is braked until the vehicle/

trailer combination is stabilized. If necessary, the vehicle's engine output is limited.

If your vehicle with trailer (vehicle/trailer combination) starts to swerve, you will be able to stabilize the vehicle/trailer combination only by braking. ESP® trailer stabilization helps you to stabilize the vehicle/trailer combination in this situation.

ESP® trailer stabilization is activated above speeds of about 40 mph (65 km/h).

If ESP® is switched off or deactivated because of a malfunction, the trailer stabilization system will not function.

Crosswind Assist

Observe the important safety guidelines for the driving safety system (> page 64).

Strong crosswind gusts can impair the road-holding of your vehicle when driving straight ahead. The Crosswind Assist function integrated in ESP® reduces these impairments.

Depending on the direction and intensity of the side wind, Crosswind Assist intervenes automatically. ESP® intervenes with stabilizing braking to assist you in keeping the vehicle in the lane. When Crosswind Assist intervenes, the display shows the traffic sign for strong side winds and the **Crosswind Assist** message.

Crosswind Assist is activated automatically above a vehicle speed of approx. 50 mph (80 km/h) when the vehicle is driving straight ahead or cornering gently.

Crosswind Assist does not react:

- in the event of severe jolts and vibrations, e.g. when driving over uneven surfaces or potholes
- when grip is reduced, e.g. on snow or ice or when hydroplaning

Crosswind Assist does not work if ESP® is deactivated or disabled because of a malfunction.

Theft deterrent locking system

Immobilizer

- **To activate:** remove the key from the ignition lock.
- **To deactivate:** turn the key to position **2** in the ignition lock.

The immobilizer prevents your vehicle from being started without the correct key.

Always take the key with you and lock the vehicle when leaving the vehicle. If you leave the key in the vehicle, anyone can start the engine.

Safety

- i** The immobilizer is always deactivated when you start the engine.

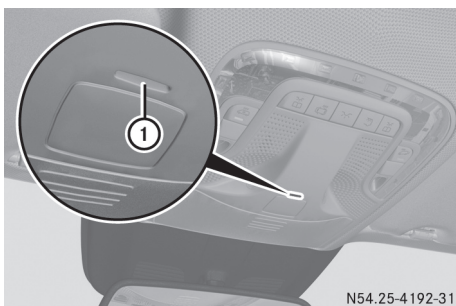

ATA (Anti-Theft Alarm system)



- ▶ **To arm:** lock the vehicle with the key.
Indicator lamp ① in the overhead control panel flashes.
 - ▶ **To disarm:** unlock the vehicle with the key.
- or
- ▶ Insert the key into the ignition lock.

If the alarm system is armed, a visual and audible alarm is triggered when the following are opened:

- a door
- the vehicle with the mechanical key
- the tailgate/rear door
- the hood

- ▶ **To stop the alarm:** press the  or  button on the key.

or

- ▶ Insert the key into the ignition lock.
The alarm stops.

The alarm is not switched off, even if you close the open door that triggered it, for example.

Useful information

This Operator's Manual describes all models as well as standard and optional equipment of your vehicle that were available at the time of going to print. Country-specific variations are possible. Note that your vehicle may not be equipped with all of the described functions. This also applies to systems and functions relevant to safety.

Read the information on qualified specialist workshops (▷ page 31).

Key

Important safety notes

WARNING

If children are left unsupervised in the vehicle, they could:

- open the doors, thus endangering other people or road users.
- get out and disrupt traffic.
- operate the vehicle's equipment.

Additionally, children could set the vehicle in motion if, for example, they:

- release the parking brake.
- shifting the automatic transmission out of park position **P**
- Start the engine.

There is a risk of an accident and injury.

When leaving the vehicle, always take the SmartKey with you and lock the vehicle. Never leave children or animals unattended in the vehicle. Always keep the SmartKey out of reach of children.

WARNING

If you attach heavy or large objects to the SmartKey, the SmartKey could be unintentionally turned in the ignition lock. This could cause the engine to be switched off. There is a risk of an accident.

Do not attach any heavy or large objects to the SmartKey. Remove any bulky key rings before inserting the SmartKey into the ignition lock.

! Keep the SmartKey away from strong magnetic fields. Otherwise, the remote control function could be affected.

Strong magnetic fields can occur in the vicinity of powerful electrical installations.



Do not keep the key:

- with electronic devices, e.g. a mobile phone or another key
- with metallic objects, e.g. coins or metal foil
- in metallic objects, e.g. metal cases

This can affect the key's functionality.

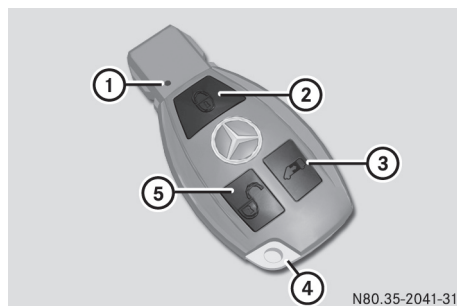
Key functions





- ① Battery check lamp
- ②  To lock the vehicle centrally
- ③  To unlock the sliding doors and the tailgate or rear door or to unlock and open or close the electric sliding door
- ④ Mechanical key
- ⑤  To unlock the vehicle centrally or unlock the front door(s) only

The vehicle's equipment includes two keys. There is a mechanical key in each key.

The key can be used to unlock the vehicle from some distance. To prevent theft, only use the key in the immediate vicinity of the vehicle.

Change the batteries immediately if battery check lamp ① does not light up briefly with every press of a button (▷ page 72).

► **To unlock centrally:** press the  button. The turn signals flash once.

- ▶ **To unlock the sliding doors and the tailgate or rear door only:** press the  button.

The turn signals flash once.

If you do not open the vehicle within approximately 40 seconds of unlocking:

- the vehicle is locked again.
- the anti-theft protection is armed again.
- ▶ **To lock centrally:** press the  button. The indicator lamps flash three times if:
 - the anti-theft protection is armed.
 - all the doors and the tailgate or rear door are closed.
- ▶ Check the locking knobs on all the doors. The locking knobs must all be in the lowered position.

The key's factory setting enables you to centrally lock and unlock the following:

- the driver's and the front-passenger door
- the sliding doors
- the tailgate or rear door

In an emergency, the driver's door can also be unlocked manually using the mechanical key (▷ page 70).

You can also set an audible signal to confirm that the vehicle has been locked. The audible locking-verification signal can be switched on/off:

- using the on-board computer on vehicles with steering wheel buttons (▷ page 188)
- at a specialist qualified workshop for vehicles without steering wheel buttons

After unlocking using the remote control, the surround lighting also goes on in the dark. For vehicles with steering wheel buttons, the surround lighting can be activated and deactivated in the on-board computer (▷ page 187).



Changing the settings of the locking system

If you travel alone a lot, you may wish to change the settings of the locking system. Press the  button to unlock:



- the driver's and front-passenger door (Cargo Van)

or

- the driver's door (Passenger Van)





- ▶ **To change the setting:** press and hold down the  and  buttons simultaneously until the battery check lamp flashes twice (▷ page 69).

If the setting of the locking system is changed within the signal range of the vehicle, press the

 or  button to:

- lock or
- unlock the vehicle

The key now functions as follows:

- ▶ **To unlock the driver's door or front doors:** press the  button once.
- ▶ **To unlock centrally:** briefly press the  button twice.
- ▶ **To lock centrally:** press the  button.
- ▶ **To restore factory settings:** press and hold down the  and  buttons simultaneously until the battery check lamp flashes twice (▷ page 69). The key unlocks the vehicle centrally again.



Mechanical key

General notes

If the vehicle can no longer be locked or unlocked with the SmartKey, use the mechanical key.

The anti-theft alarm system (ATA) is triggered when you unlock and open the vehicle using the mechanical key (▷ page 68).

The alarm can be stopped in the following two ways:

- ▶ Press the  or  button on the SmartKey.
- or
- ▶ Insert the SmartKey into the ignition lock.

Removing the mechanical key

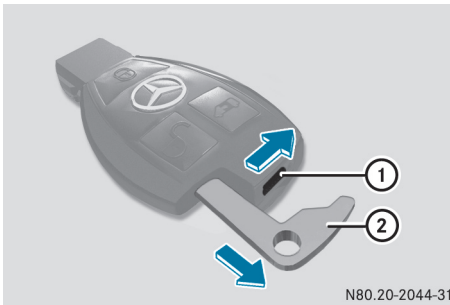

- ▶ Slide release catch ① in the direction of the arrow and, at the same time, remove mechanical key ② from the SmartKey completely.

Inserting the mechanical key

- ▶ Push mechanical key ② completely into the SmartKey until it engages and release catch ① is back in its basic position.

Unlocking/locking the vehicle using the mechanical key

The door lock for unlocking in an emergency is on the driver's door.

- ▶ **To unlock the driver's door:** insert the mechanical key fully into the driver's door lock and turn it counter-clockwise. The driver's door is unlocked.
- ▶ **To lock the vehicle:** lock all doors except the driver's door from the inside. To do this, push down the door-locking knobs.
- ▶ Insert the mechanical key fully into the driver's door lock and turn it clockwise. The driver's door is locked.

Battery of the key

Important safety notes

WARNING

Batteries contain toxic and corrosive substances. If batteries are swallowed, it can result in severe health problems. There is a risk of fatal injury.

Keep batteries out of the reach of children. If a battery is swallowed, seek medical attention immediately.

Environmental note



Batteries contain dangerous substances. It is against the law to dispose of them with the household rubbish. They must be collected separately and recycled to protect the environment.







Dispose of batteries in an environmentally friendly manner. Take discharged batteries to a qualified specialist workshop or a special collection point for used batteries.

Mercedes-Benz recommends that you have the battery changed at a qualified specialist workshop.

Checking the battery



- ▶ Press the  or  button. If battery check lamp ① lights up briefly, the battery is sufficiently charged. If battery check lamp ① does not light up briefly, the battery is empty.
 - ▶ Change the battery (▷ page 72).
- If the SmartKey battery is checked within the signal range of the vehicle, pressing the  or  button results in:
- lock or
 - unlock the vehicle

- i** The battery may be obtained at any qualified specialist workshop.

Changing the battery

You need a type CR 2025 3 V cell battery.

- ▶ Pull out the mechanical key from the SmartKey (▷ page 70).

Opening and closing

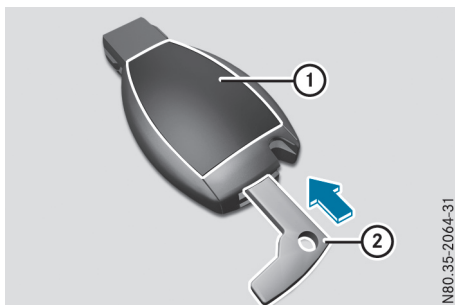

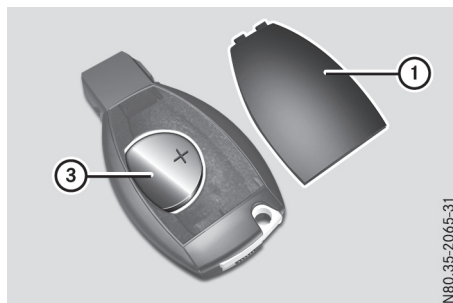

- ▶ Push mechanical key (2) into the opening in the SmartKey in the direction of the arrow until battery compartment cover (1) opens. When doing so, do not hold battery compartment cover (1) shut.
- ▶ Remove battery compartment cover (1).



- ▶ Tap the SmartKey against the palm of your hand so that battery (3) falls out of the battery compartment.
- ▶ Insert the new battery into the battery tray with the positive pole facing upwards. Use a lint-free cloth to do so.
- ▶ Install battery compartment cover (1) to the key casing with the front lugs first and push closed.
- ▶ Slide mechanical key (2) back into the SmartKey (▷ page 71).
- ▶ Check the function of all SmartKey buttons on the vehicle.

Problems with the key

Problem	Possible causes/consequences and ▶ Solutions
It is no longer possible to lock the vehicle using the SmartKey.	The doors are not closed properly. ▶ Close the doors properly and lock the vehicle again.
The turn signals do not flash when the vehicle is locked.	The central locking system has malfunctioned. ▶ Lock the vehicle using the mechanical key (▷ page 71) or press down the locking knob and then close the doors. ▶ Have the central locking system checked as soon as possible at a qualified specialist workshop.
It is no longer possible to lock or unlock the vehicle using the SmartKey.	The SmartKey battery is weak or discharged. ▶ Point the tip of the SmartKey at the driver's door handle from very close range and press the  or  button. If this does not work: ▶ Replace the SmartKey battery (▷ page 72). or ▶ Lock or unlock the vehicle using the mechanical key (▷ page 71).

Problem	Possible causes/consequences and ► Solutions
	<p>The SmartKey is faulty.</p> <ul style="list-style-type: none"> ► Lock the vehicle with the mechanical key (▷ page 71). ► Have the SmartKey checked at a qualified specialist workshop.
The engine cannot be started using the SmartKey.	<p>The on-board voltage is too low.</p> <ul style="list-style-type: none"> ► Switch off all non-essential consumers, such as interior lighting, and try to start the engine again. <p>If this does not work:</p> <ul style="list-style-type: none"> ► Check the starter battery and charge it if necessary (▷ page 262). <p>or</p> <ul style="list-style-type: none"> ► Jump-start the vehicle (▷ page 272). <p>or</p> <ul style="list-style-type: none"> ► Consult a qualified specialist workshop.
You have lost a SmartKey.	<ul style="list-style-type: none"> ► Have the SmartKey deactivated at a qualified specialist workshop. ► Report the loss immediately to the vehicle insurers. ► If necessary, have the mechanical locks replaced.
You have lost the mechanical key.	<ul style="list-style-type: none"> ► Report the loss immediately to the vehicle insurers. ► If necessary, have the mechanical locks replaced.

Central locking

Important safety notes

WARNING

If children are left unsupervised in the vehicle, they could:

- open the doors, thus endangering other people or road users.
- get out and disrupt traffic.
- operate the vehicle's equipment.

Additionally, children could set the vehicle in motion if, for example, they:

- release the parking brake.
- shifting the automatic transmission out of park position **P**
- Start the engine.

There is a risk of an accident and injury.

When leaving the vehicle, always take the SmartKey with you and lock the vehicle. Never leave children or animals unattended in the

vehicle. Always keep the SmartKey out of reach of children.

WARNING



If persons, particularly children are subjected to prolonged exposure to extreme heat or cold, there is a risk of injury, possibly even fatal. Never leave children unattended in the vehicle.

You can open a locked door from the inside at any time. For the sliding doors, the child-proof locks must be deactivated.

Centrally locking and unlocking the vehicle from the inside

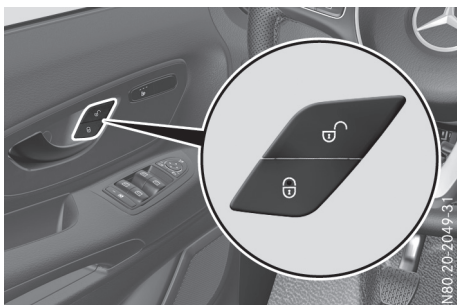
You can centrally lock and unlock the whole vehicle from the inside using the central locking buttons on the driver's door.



- ▶ **To unlock:** press the  button.
- ▶ **To lock:** press the  button.
If the driver's or front-passenger door is open, the open door is not locked.
All other doors and the tailgate/rear doors are locked.
If a sliding door or the tailgate/rear door is open, only the driver's and front-passenger doors are locked.



You cannot unlock the vehicle centrally from the inside if the vehicle has been locked with the key.

If the vehicle has been locked using the locking button for the central locking and a door is opened from the inside, only the door that has been opened is unlocked.

If the vehicle has previously been locked with the key, opening a door from the inside will trigger the anti-theft alarm system. Switch off the alarm (▷ page 68).

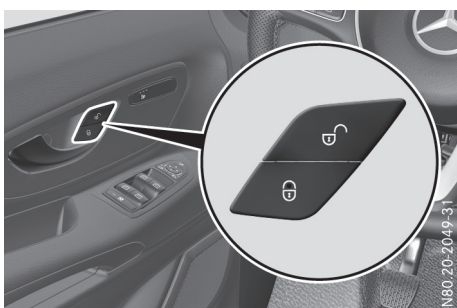
Automatic locking



- ▶ **To switch on:** press and hold the  button until an acoustic tone sounds.
- ▶ **To switch on :** press and hold the  button until an acoustic tone sounds.

When the ignition is switched on, the vehicle will lock automatically from a speed of approximately 9 mph (15 km/h).

You could therefore be locked out if:

- the vehicle is being pushed.
- the vehicle is being towed.
- the vehicle is being tested on a dynamometer.

If the vehicle has been automatically locked and a front door is opened from the interior while the vehicle is stationary, the vehicle unlocks centrally.

Driver's door and front-passenger door

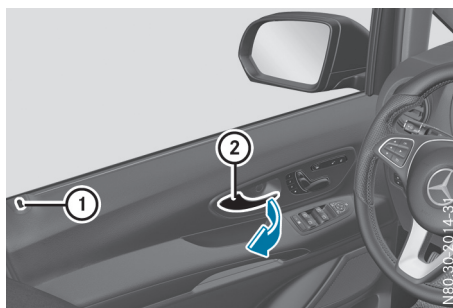

Door handle (example driver's door)

You can open the driver's or front-passenger door from the inside at any time, even if it is locked.

- ▶ Pull door handle ②.
If a front door is locked, locking knob ① pops up. The door is unlocked and opens.

Sliding door

Important safety notes

WARNING

When you open the sliding door, the sliding door could hit other people as it moves backwards. There is a risk of injury.

Only open the sliding door when traffic conditions permit.

⚠ WARNING

If the open sliding door is not engaged, it could move on its own if the vehicle is on a slope. This could trap you or other persons. There is a risk of injury.

Always make sure that the open sliding door is engaged.

! Do not use the lower sliding door guide (carriage) as a step. Otherwise, you could damage the paneling and/or the sliding door mechanism.

! When you open the sliding door, first make sure that:

- the rear door is not opened to an angle of 270°.
- the rear door is not clipped into the door retainer.

The sliding door could otherwise collide with the opened rear door and the doors could be damaged.

Information on opening and closing the rear doors can be found under "Rear doors" (▷ page 79).

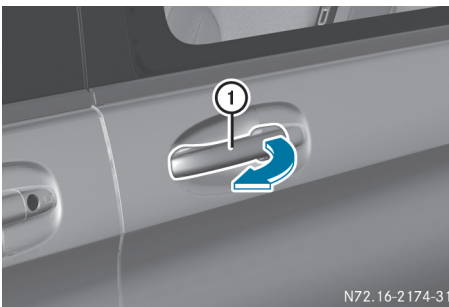
Opening and closing from the outside

The sliding door is equipped with an active retainer, which engages the door at the end stop when opened.

- ▶ **To open:** pull door handle ① in the direction of the arrow.
The sliding door opens.
- ▶ Push back the sliding door using door handle ① until it engages.
- ▶ Check the sliding door detent.

- ▶ **To close:** pull door handle ① in the direction of the arrow.
The sliding door is released from its lock.
- ▶ Push the sliding door forwards using door handle ① and close.

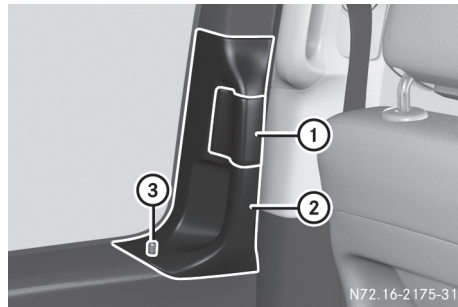
Opening/closing from the inside

The sliding door is equipped with an active retainer, which engages the door at the end stop when opened.

- ▶ **To open:** pull back rocker switch ①.
If the door is locked, locking knob ③ pops up. The sliding door unlocks and opens.
- ▶ Push back the sliding door using door handle ② until it engages
- ▶ Check the sliding door detent.
- ▶ **To close:** press rocker switch ① forwards.
The sliding door is released from its lock.
- ▶ Push the sliding door forwards using door handle ② and close.

Electric sliding door**Important safety notes****⚠ WARNING**

When you open the sliding door, the sliding door could hit other people as it moves backwards. There is a risk of injury.

Only open the sliding door when traffic conditions permit.

- !** Do not use the lower sliding door guide (carriage) as a step. Otherwise, you could damage the paneling and/or the sliding door mechanism.

You must reset the electric sliding door if there has been a malfunction or an interruption in the voltage supply (▷ page 78).

i Please note, if the child-proof locks have been activated, you cannot open the sliding door from the inside. You can only open a sliding door from the inside if the child-proof locks have not been activated. Further information can be found under "Child-proof locks for the sliding door" (▷ page 63) and "Opening/closing from the inside" (▷ page 77).

Obstacle detection with reversing feature

The sliding door is equipped with automatic obstacle detection with reversing feature. If a solid object blocks or restricts the sliding door during the automatic closing process, the sliding door opens again automatically. If the sliding door is obstructed during the opening procedure, it moves back a few centimeters in the opposite direction and stops.

Automatic obstacle detection with reversing feature is only an aid. It is not a substitute for your attentiveness when closing the electrical sliding door.

If an obstacle is detected, the display shows the **Left-hand Electric Sliding Door Obstruction Detected** message for example, and five warning tones sound.

⚠ WARNING

The reversing feature does not react:

- to soft, light and thin objects, e.g. small fingers
- over the last 8 mm of the closing movement

This means that the reversing feature cannot prevent someone being trapped in these situations. There is a risk of injury.

When closing, make sure that no-one has any parts of the body within the closing area.

If someone is trapped:

- press the  button on the SmartKey, or
- pull the exterior door handle, or
- press the corresponding sliding door button in the center console, or

- press the button on the door frame, or
- pull the rocker switch on door handle

Opening/closing from the outside

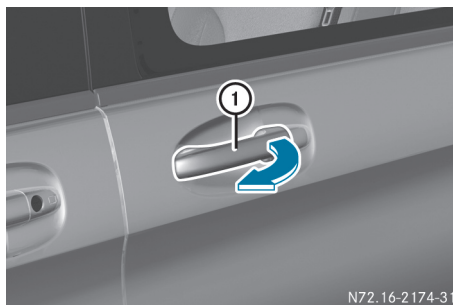

The sliding door is equipped with an active retainer, which engages the door at the end stop when opened.

If the vehicle is equipped with two electric sliding doors; the  button on the SmartKey can only be used to open or close one of the two sliding doors (▷ page 78).

► **To open:** pull door handle ① in the direction of the arrow.

or

► Press the  button on the SmartKey for longer than 0.5 seconds.

The sliding door unlocks, automatic operation is started and the sliding door opens. In addition, you will hear two warning signals.

► **To close:** pull door handle ① in the direction of the arrow.

or

► Press the  button on the SmartKey for longer than 0.5 seconds.

The sliding door is released from its lock and automatic operation is started. The sliding door closes.

If you press the  button on the SmartKey, you will hear two warning signals while the doors close.

► **To interrupt automatic operation:** pull door handle ① again.

or



► Press the  button on the SmartKey again.

i In unfavorable operating conditions, e.g. frost, ice or heavy soiling, you can press and

hold the relevant sliding door button. The electric sliding door moves with increased force. Observe that, in such circumstances, the obstacle detection is less sensitive. To stop the movement, release the sliding door button.

Opening/closing from the inside

If the sliding door is unlocked, you can open and close the sliding door from the inside with these controls:

- the  or  sliding door button in the front on the lower center console
- the sliding door button on the B-pillar next to the door sill
- the rocker switch on the door handle

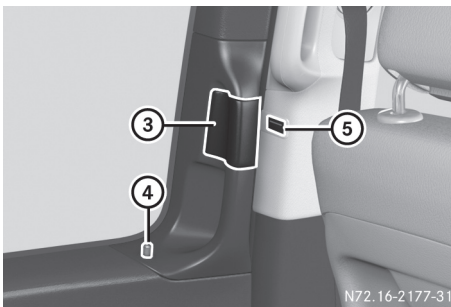
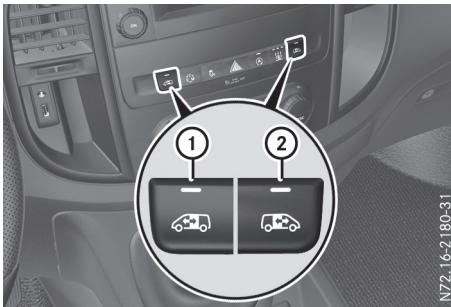



- ① Sliding door button for the sliding door on the left-hand side
- ② Sliding door button for the sliding door on the right-hand side
- ③ Rocker switch
- ④ Locking knob
- ⑤ Sliding door button in the door frame

You can only open a sliding door from the inside if the child-proof locks have not been activated.

If the sliding door is locked, the sliding door must first be unlocked.

The sliding door is equipped with an active retainer, which engages the door at the end stop when opened.



► **To open:** briefly press the respective  or  sliding door button in the center console.



or



► Briefly press sliding door button ⑤ in the door frame.

or



► Briefly pull back rocker switch ③. If the sliding door is unlocked, automatic operation is started and the sliding door opens.

If you use the  or  sliding door button in the center console you will hear two warning signals during the opening procedure.

The indicator lamp in the  or  sliding door button in the center console flashes for the duration of automatic operation.

The indicator lamp in the  or  sliding door button in the center console is lit whenever the respective sliding door is open.

Depending on the vehicle equipment, the display can also show the **Sliding Door Open** message.



► **To close:** briefly press the respective  or  sliding door button in the center console.



or



► Briefly press sliding door button ⑤ in the door frame.

or

► Briefly press rocker switch ③ forward. The sliding door is released from its lock and automatic operation is started. The sliding door closes.

If you use the  or  sliding door button in the center console you will hear two warning signals during the closing procedure.

The indicator lamp in the respective  or  sliding door button in the center console goes out whenever the sliding door is closed.



► **To interrupt automatic operation:** press the respective  or  sliding door button in the center console again.

or



- ▶ Press sliding door button in the door frame ⑤.
- or
- ▶ Briefly pull back rocker switch ③.

i In unfavorable operating conditions, e.g. frost, ice or heavy soiling, you can press and hold the relevant sliding door button. The electric sliding door moves with increased force. Observe that, in such circumstances, the obstacle detection is less sensitive. To stop the movement, release the sliding door button.

Programming the key button for the sliding door

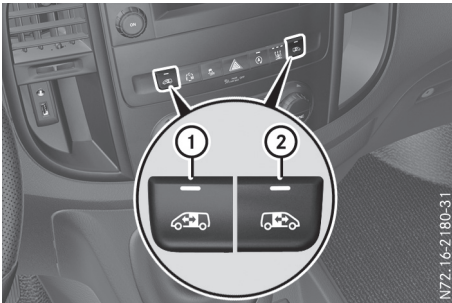



If the vehicle is equipped with two electric sliding doors, the  sliding door button on the key can only be programmed for one of the two sliding doors. You can then open or close the selected sliding door with the  button on the key.



- ① Sliding door button for sliding door on the left-hand side
 - ② Sliding door button for sliding door on the right-hand side
- ▶ Make sure that the sliding door to be programmed is open.
 - ▶ Turn the key to position 2 in the ignition lock.
 - ▶ Press and hold the  or  sliding door button in the center console for the appropriate sliding door until the sliding door is closed and four tones have sounded. The display shows the **Left-hand Electric Sliding Door Key Programmed/ Right-hand Electric Sliding Door Key Programmed** or **L. Slide Door Programmed/R. Slide Door Programmed** message.

Resetting the sliding door

You must reset the sliding door if there has been a malfunction or an interruption in the voltage supply.

- ▶ If the sliding door is open: close it by hand.
- ▶ Using the  or  sliding door button on the center console, open the sliding door at least 15.8 in (40 cm) and then close the sliding door completely.
- ▶ When the sliding door is closed, open the sliding door fully using the  or  sliding door button on the center console. The sliding door is reset and operational.
- ▶ Close the sliding door if required.

Problems with the sliding door

The electric sliding door is locked in place.

Unfavorable operating conditions, e.g. frost, ice or heavy soiling, may obstruct the sliding door.

- ▶ Press and hold the sliding door button until the sliding door has opened or closed. The sliding door moves with increased force. Observe that, in such circumstances, the obstacle detection is less sensitive. To stop the movement, release the sliding door button.
- ▶ Remove the cause of the blockage at the earliest opportunity.

Tailgate

Important safety notes

WARNING

Combustion engines emit poisonous exhaust gases such as carbon monoxide. If the tailgate is open when the engine is running, particularly if the vehicle is moving, exhaust fumes could enter the passenger compartment. There is a risk of poisoning.

Turn off the engine before opening the tailgate. Never drive with the tailgate open.

- !** The tailgate swings upwards and to the rear when opened. Therefore, make sure that there is sufficient clearance above and behind the tailgate.

You will find details of the tailgate opening dimensions under "Technical data" (▷ page 311).

Opening and closing

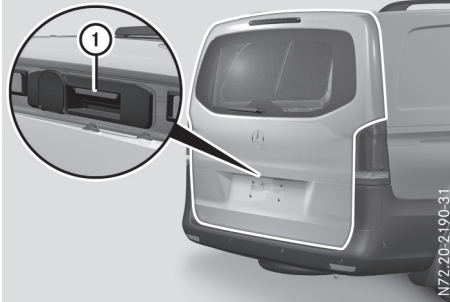

- ▶ **To open:** press button ① on the handle.
- ▶ Raise the tailgate.

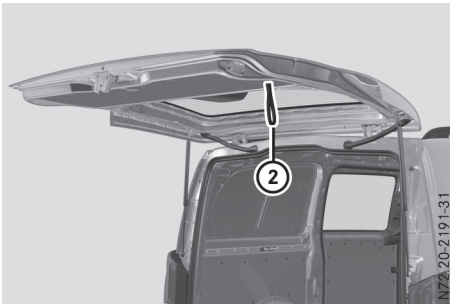

- ▶ **To close:** pull the tailgate firmly downwards by strap ② and close it from outside.

Problems with the tailgate

The tailgate cannot be opened.

The voltage supply has been interrupted or the battery charge is insufficient.

Consult a qualified specialist workshop which has the necessary specialist knowledge and tools to carry out the work required.

In an emergency, you can open the tailgate using the release catch for service purposes.

- ▶ Pry off the cover on the lower part of the tailgate with a suitable tool, e.g. the screwdriver from the vehicle tool kit.
- ▶ Insert the screwdriver into the opening and move the release lever until the tailgate unlocks and opens.
- ▶ Swing the tailgate upwards.

Rear doors

Important safety notes

WARNING

Combustion engines emit poisonous exhaust gases such as carbon monoxide. If the rear door is open when the engine is running, particularly if the vehicle is moving, exhaust fumes could enter the passenger compartment. There is a risk of poisoning.

Turn off the engine before opening the rear door. Never drive with the rear door open.

WARNING

If you open a rear door, you could:

- endanger other people or road users
- be caught by oncoming traffic

This is particularly the case if you open the rear door more than 90°. There is a risk of an accident and injury.

Only open the rear doors when traffic conditions permit. Always make sure that the rear doors are properly locked.

WARNING

If you open the rear doors 90°, the rear lights are no longer visible. The vehicle will then be difficult for other road users to see or will not be seen by them at all, particularly if it is dark or visibility is poor. There is a risk of an accident.

You should therefore ensure in this and similar situations that the vehicle is visible from the rear in accordance with the relevant

national regulations, by using the warning triangle, for instance.

- ! Make sure that there is sufficient clearance when opening the rear doors. You could otherwise damage the vehicle and objects in close range of the rear doors.

You can lock the rear doors at an angle of approx. 90° and, if necessary, 180° or 270°. Always make sure that the open rear door is correctly engaged in the detent.

Opening and closing from the outside

Opening the right-hand rear door

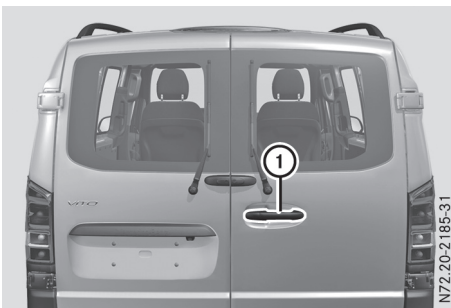

- ▶ Pull handle ①.
- ▶ Swing the rear door to the side until it engages.

The rear door can also be opened beyond 90 degrees (▷ page 81).

Opening the left-hand rear door

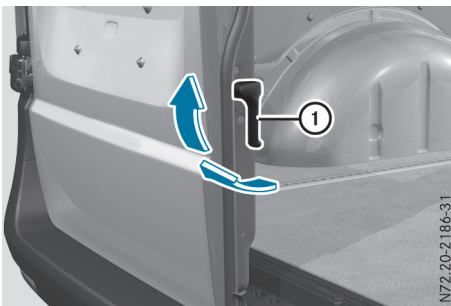

- ▶ Make sure that the right-hand rear door is open and engaged.
- ▶ Pull release handle ① in the direction of the arrow.
- ▶ Swing the rear door to the side until it engages.

The rear door can also be opened beyond 90 degrees (▷ page 81).

Closing the rear doors from the outside

- ▶ If necessary, pull the rear door away from the magnetic door retainer (▷ page 81).
- ▶ Close the left-hand rear door firmly from the outside.
- ▶ Close the right-hand rear door firmly from the outside.

Opening/closing from the inside

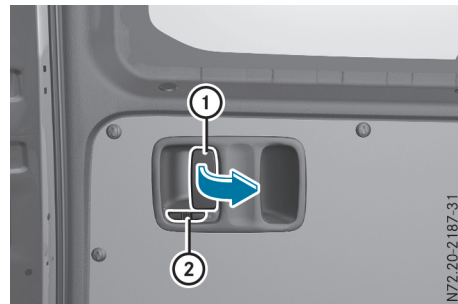

Release the lever on the inside of the right rear door. A white section on latch ② indicates that the rear door is unlocked.

- i You can only open the locked rear doors from the inside if the child-proof locks have not been activated.
- ▶ **To unlock:** slide latch ② to the left. You will see a white marking.
- ▶ **To open:** pull opening lever ① up and open the rear door.
- ▶ Swing the rear door to the side until it engages.
- i If you open a locked rear door from inside, you only unlock the rear door. The other doors remain locked.

The rear door can also be opened beyond 90 degrees (▷ page 81).

- ▶ **To close:** make sure that the left-hand rear door is closed.
- ▶ Pull the rear door firmly by the door handle to close it.
- ▶ **To lock:** slide latch ② to the right. The white section is no longer visible.

Opening at an angle of 180° or 270°

Depending on the vehicle equipment, you can open the rear doors up to an angle of 180° or 270° (side wall).

! When you open the sliding door, first make sure that:

- the rear door is not opened to an angle of 270°.
- the rear door is not clipped into the door retainer.

The sliding door could otherwise collide with the opened rear door and the doors could be damaged.

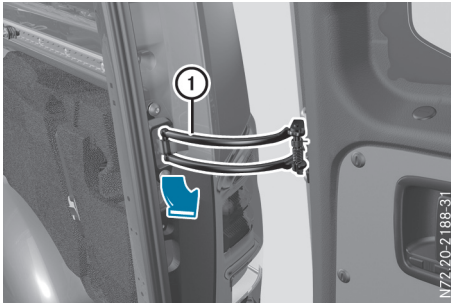

Door retainer (example: right rear door)

- ▶ Open the rear door to about 45°.
- ▶ Pull and hold door retainer ① in the direction of the arrow.
- ▶ Open the rear door more than 90°, so that the door retainer cannot engage.
- ▶ Release the door retainer and open the door to an angle of 180° or 270°.

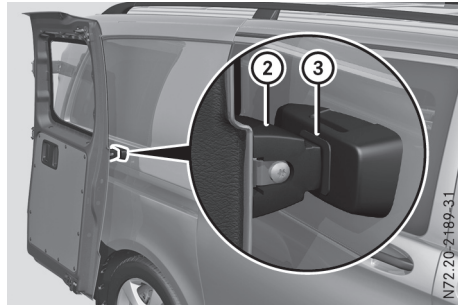

Magnetic door retainer

- ▶ With the rear door opened to an angle of 270° push it against the magnetic door retainer ③ on the side wall. When the magnet on rear door ② is in contact with magnetic door retainer ③, the rear door is held in this position.

Side windows

Important safety notes

⚠ WARNING

While opening the side windows, body parts could become trapped between the side window and the door frame as the side window moves. There is a risk of injury.

Make sure that nobody touches the side window during the opening procedure. If somebody becomes trapped, release the switch or pull the switch to close the side window again.

⚠ WARNING

While closing the side windows, body parts in the closing area could become trapped. There is a risk of injury.

When closing make sure that no parts of the body are in the closing area. If somebody becomes trapped, release the switch or press the switch to open the side window again.

⚠ WARNING

If children operate the side windows they could become trapped, particularly if they are left unsupervised. There is a risk of injury.

Activate the override feature for the rear side windows. When leaving the vehicle, always take the SmartKey with you and lock the vehicle. Never leave children unsupervised in the vehicle.

WARNING

If persons, particularly children are subjected to prolonged exposure to extreme heat or cold, there is a risk of injury, possibly even fatal. Never leave children unattended in the vehicle.

Side window reversing feature

The front side windows are equipped with an automatic reversing feature. If a solid object blocks or restricts a side window from moving upwards during the automatic closing process, the side window opens again automatically. During the manual closing process, the side window only opens again automatically after the corresponding switch is released. The automatic reversing feature is only an aid and is no substitute for your attention when closing a side window.

WARNING

The reversing feature does not react:

- to soft, light and thin objects, e.g. small fingers
- while resetting

This means that the reversing feature cannot prevent someone being trapped in these situations. There is a risk of injury.

Make sure that no body parts are in close proximity during the closing procedure. If someone becomes trapped, press the switch to open the side window again.

Opening and closing the side windows

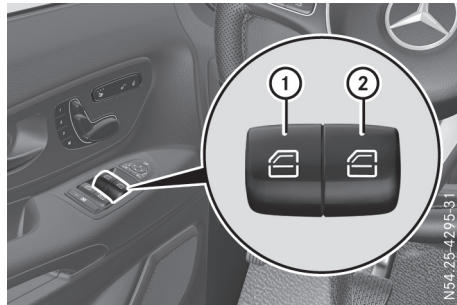

- ① Power window, left
- ② Power window, right

The switches on the driver's door take precedence.

- ▶ **To open manually:** press and hold the corresponding switch.
- ▶ **To open fully:** press the switch beyond the point of resistance and release it. Automatic operation is started.
- ▶ **To close manually:** pull the corresponding switch and hold it.
- ▶ **To close fully:** pull the corresponding switch beyond the point of resistance and release it. Automatic operation is started.
- ▶ **To interrupt automatic operation:** press/pull the corresponding switch again.



You can continue to operate the side windows after switching off the engine or removing the SmartKey. This function remains active for about five minutes or until you open a front door.

Convenience opening feature

You can ventilate the vehicle before you start driving. To do this, the key is used to carry out the following functions simultaneously:

- to unlock the vehicle
- to open the side windows

The convenience opening feature can only be operated using the key. The key must be close to the driver's door handle.

- ▶ **Convenience opening:** point the tip of the key at the driver's door handle.
- ▶ Press and hold the  button until the side windows are in the desired position.
- ▶ **To interrupt convenience opening:** release the  button.

Convenience closing feature

WARNING



When using the convenience closing feature, parts of the body could be trapped in the closing area when a side window is being closed. There is a risk of injury.

Observe the complete closing procedure when the convenience closing feature is operating. Make sure that no body parts are in close proximity during the closing procedure.

When you lock the vehicle, you can close the side windows at the same time.

The SmartKey must be close to the driver's door handle.

Observe the notes on the automatic reversing feature for the side windows (> page 82).

- ▶ **Convenience closing feature:** point the tip of the SmartKey at the driver's door handle.
- ▶ Keep the  button pressed until all side windows are fully closed.
- ▶ Make sure that all side windows are closed.
- ▶ **To interrupt convenience closing feature:** release the  button.

Resetting the side windows

You must reset the side windows if there has been a malfunction or an interruption in the voltage supply.

- ▶ Turn the SmartKey to position **2** in the ignition lock.
- ▶ Pull the two power window switches and hold for approximately one second after closing the side window.
- ▶ If the side windows remain closed after the button has been released, they have been reset correctly. If this is not the case, repeat the steps above for the open window.

Problems with the side windows

WARNING

If you close a side window again immediately after it has been blocked or reset, the side window closes with increased or maximum force. The reversing feature is then not active. Parts of the body could be trapped in the closing area in the process. This poses an increased risk of injury or even fatal injury.

Make sure that no parts of the body are in the closing area. To stop the closing process, release the switch or push the switch again to reopen the side window.

If you cannot completely open or close a side window:

If there are no objects or leaves in the window guide that prevent the sliding sunroof from closing, there has been a malfunction or the on-board voltage has been interrupted.

- ▶ Reset the side window (> page 83).

Useful information

This Operator's Manual describes all models as well as standard and optional equipment of your vehicle that were available at the time of going to print. Country-specific variations are possible. Note that your vehicle may not be equipped with all of the described functions. This also applies to systems and functions relevant to safety.

Read the information on qualified specialist workshops (▷ page 31).

Seats

Driver's and front-passenger seat

Important safety notes

WARNING

Children could become trapped if they adjust the seats, particularly when unattended. There is a risk of injury.

When leaving the vehicle, always take the SmartKey with you and lock the vehicle. Never leave children unsupervised in the vehicle.

WARNING

You could lose control of your vehicle if you do the following while driving:

- adjust the driver's seat, head restraint, steering wheel or mirrors
- fasten the seat belt

There is a risk of an accident.

Adjust the driver's seat, head restraint, steering wheel and mirror and fasten your seat belt before starting the engine.

WARNING

When you adjust a seat, you or other vehicle occupants could become trapped, e.g. on the seat guide rail. There is a risk of injury.

Make sure when adjusting a seat that no one has any body parts in the sweep of the seat.

WARNING

If the driver's seat is not engaged, it could move unexpectedly while the vehicle is in motion. This could cause you to lose control of the vehicle. There is a risk of an accident.

Always make sure that the driver's seat is engaged before starting the vehicle.

WARNING

The front-air bags for could also injure the vehicle occupants in the front if the front seats are positioned too close to the dashboard or steering wheel. This poses an increased risk of injury or even fatal injury.

Always adjust the front seats so that they are as far from the front air bags as possible. Also observe the notes on the correct adjustment of the seats.

WARNING

The seat belt does not offer the intended level of protection if you have not moved the backrest to an almost vertical position. When braking or in the event of an accident, you could slide underneath the seat belt and sustain abdomen or neck injuries, for example. This poses an increased risk of injury or even fatal injury.

Adjust the seat properly before beginning your journey. Always ensure that the backrest is in an almost vertical position and that the shoulder section of your seat belt is routed across the center of your shoulder.

WARNING

If the head restraints are not installed or not adjusted correctly, they cannot provide protection as intended. There is an increased risk of injury in the head and neck area, e.g. in the event of an accident or when braking.

Always drive with the head restraints installed. Before driving off, make sure for every vehicle occupant that the center of the head restraint supports the back of the head at about eye level.

! To avoid damage to the seats and the seat heating, observe the following information:

- keep liquids from spilling on the seats. If liquid is spilled on the seats, dry them as soon as possible.
- if the seat covers are damp or wet, do not switch on the seat heating. The seat heating should also not be used to dry the seats.
- clean the seat covers as recommended; see the "Interior care" section.
- do not transport heavy loads on the seats. Do not place sharp objects on the seat cushions, e.g. knives, nails or tools. The seats should only be occupied by passengers, if possible.
- when the seat heating is in operation, do not cover the seats with insulating materials, e.g. blankets, coats, bags, seat covers, child seats or booster seats.

Your seat must be adjusted in such a way that you can wear the seat belt correctly.

Observe the following points:

- Position the backrest in an almost vertical position so that you are sitting virtually upright. Do not drive with the backrest reclined too far back.
- Your arms should be slightly bent when you are holding the steering wheel.
- Avoid seat positions that prevent the seat belt from being correctly routed. The shoulder section of the belt must be routed over the middle of your shoulder and be pulled tight against your upper body. The lap belt must always pass across your lap as low down as possible, i.e. over your hip joints.
- Adjust the head restraint so that it supports the back of the head at eye level.
- The distance from the pedals should be such that you can depress them fully.

Please also observe the important safety notes on "Air bags" (▷ page 50), "Seat belts" (▷ page 47) and "Child restraint systems" (▷ page 59).

Adjusting the seat manually

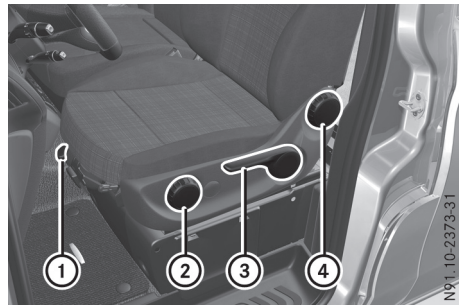

- ① Seat fore-and-aft adjustment
- ② Seat cushion angle adjustment
- ③ Seat height adjustment
- ④ Seat backrest adjustment

► **To adjust the seat fore-and-aft position:** pull lever ① up.

► Slide the seat forward or back until you can depress the pedals.

► Release lever ①.

► Slide the seat forward or back until you hear it engage.

► **To adjust the seat height:** press or pull lever ③ repeatedly until you have reached the desired seat height.

► **To adjust the backrest:** turn handwheel ④ towards the front. The seat backrest moves to a vertical position.

► Turn handwheel ④ towards the rear. The seat backrest tilts towards the rear.

► **To adjust the seat angle:** turn handwheel ② towards the front. The front of the seat cushion tilts down.

► Turn handwheel ② towards the rear. The front of the seat cushion tilts up.

Adjusting lumbar support

To support the lumbar region, you can set the backrest contour of each front seat (4-way lumbar support) electrically.

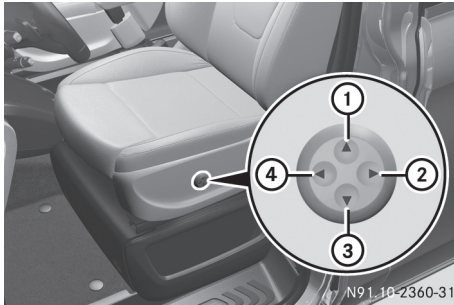

Electrically adjustable lumbar support

- ① To raise the backrest contour
- ② To soften the backrest contour
- ③ To lower the backrest contour
- ④ To harden the backrest contour

Rear bench seats

General notes

For a variable configuration of the vehicle interior in the rear, you can:

Rear bench seat

- remove the rear bench seat by releasing the quick-locking mechanism (▷ page 88)

Bench seat anchorage

WARNING

If the rear bench seat is not fully engaged, it may be thrown about while the vehicle is moving. There is a risk of an accident and injury.

Always make sure that the rear bench seat is fully engaged as described.

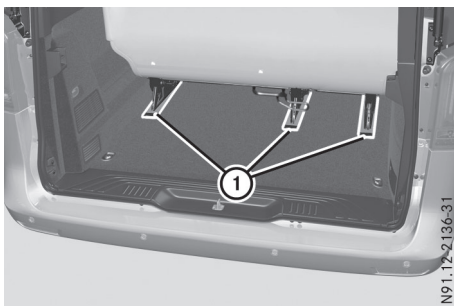

Example: seat rail system with quick-locking mechanism

Guide rails ① of the seat rail system allow you to:

- secure rear bench seats in up to two rear seat rows

The only way to ensure that the rear bench seats will engage securely is to always keep the seat anchorages clean and free of foreign objects.

Seating variants

WARNING

If the rear bench seats are not installed as described, the safety precautions integrated into the rear bench seats cannot protect as intended. There is an increased risk of injury.

Only install the rear bench seats as described. Only use rear bench seats approved for the vehicle.

You can install rear bench seats with two or three seats.

The seating variants shown are only permitted if the conditions named below for safe rear seating are met. Other seating variants are not permitted and can endanger the occupants.

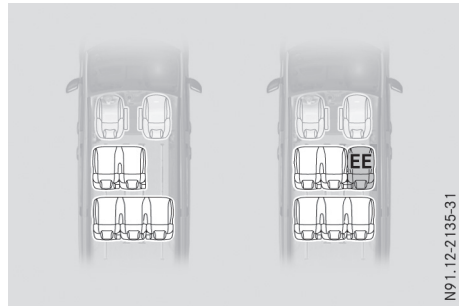

Seating variants facing forwards

EE EASY-ENTRY/EXIT feature

If a rear bench seat is marked with **EE** in the illustrations, a rear bench seat must be installed with the EASY-ENTRY/EXIT feature in the position indicated.

If a rear bench seat is not marked, a rear bench seat without an EASY-ENTRY/EXIT section must be installed in the position indicated.

Please observe the following conditions for safe rear seating:

- Only use rear bench seats approved for the vehicle.
- A rear bench seat with three seats **without** EASY-ENTRY/EXIT feature may only be installed if there is no other row of rear seats behind it.
- Passengers may only use the seats if the rear bench seat has engaged correctly (> page 88).

EASY-ENTRY/EXIT feature

WARNING

If the rear bench seat is not fully engaged, it may be thrown about while the vehicle is moving. There is a risk of an accident and injury. Always make sure that the rear bench seat is fully engaged as described.

WARNING

When you adjust a seat, you or other vehicle occupants could become trapped, e.g. on the seat guide rail. There is a risk of injury.

Make sure when adjusting a seat that no one has any body parts in the sweep of the seat.

WARNING

The rear bench seat will not engage when folded forward. The rear bench seat may inadvertently fold backward while accelerating, braking, changing direction suddenly or in the event of an accident, for example. People within the sweep of the rear bench seat may become trapped. There is a risk of injury.

Before driving off, always fold back the rear bench seat if it is folded forward. Make sure that the rear bench seat is fully engaged.

The only way to ensure that the rear bench seat will engage securely is to always keep the seat anchorages clean and free of foreign objects.

The rear seat leg is only engaged when the red indicator tab is no longer visible and is fully retracted into the seat leg.

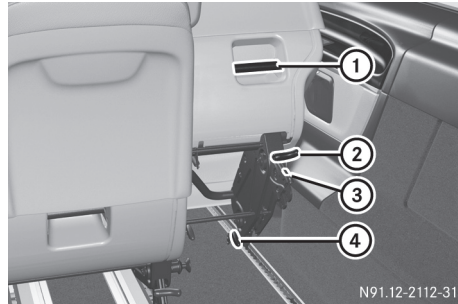

Rear bench seat with EASY-ENTRY

- ① Handle
- ② EASY-ENTRY release handle
- ③ Indicator tab for seat legs locking mechanism
- ④ Release handle for front seat legs

If you fold the EASY-ENTRY section of the rear bench seat forward, it is simpler and easier to get into or out of the second row of seats.

► **To fold the EASY-ENTRY section forward:** pull EASY-ENTRY release handle ② up.

► Fold the EASY-ENTRY section forward with the aid of release handle ②.

► **To fold the EASY-ENTRY section back:** fold the EASY-ENTRY section back until it engages in the seat anchorages.

Indicator tab ③ is no longer visible.

The EASY-ENTRY section has engaged correctly if:

- the seat legs engages audibly
- indicator tab ③ is no longer visible and is fully retracted into the seat leg

► **To remove the EASY-ENTRY section:** pull EASY-ENTRY release handle ② up.

► Fold the EASY-ENTRY section forward.

► Pull the release handle for front seat legs ④ up.

► Fold the EASY-ENTRY section further forward.

► Lift the EASY-ENTRY section up and out of the anchorage.

► **To install the EASY-ENTRY section:** place the front seat leg of the EASY-ENTRY section on the seat anchorage and allow to engage.

► Fold the EASY-ENTRY section back.

The rear seat leg of the EASY-ENTRY section engages audibly. Indicator tab ③ on the seat leg is no longer visible.

The EASY-ENTRY section has engaged correctly if:

- the seat legs engages audibly
- indicator tab ③ is no longer visible and is fully retracted into the seat leg

If the EASY-ENTRY section has not engaged correctly:

- ▶ Fold the EASY-ENTRY section forward.
- ▶ Fold the EASY-ENTRY section back again and check the locking mechanism.

Removing/installing the rear bench seat

Standard rear bench seat:

WARNING

If the rear bench seat is not fully engaged, it may be thrown about while the vehicle is moving. There is a risk of an accident and injury. Always make sure that the rear bench seat is fully engaged as described.

WARNING

If the rear bench seat is not installed as described or an unsuitable rear bench seat is installed, the seat belts may not provide protection as intended. There is an increased risk of injury.

Install the rear bench seat as described. Only use rear bench seats that are approved for your vehicle by the distributor named on the inside cover page.

The only way to ensure that the rear bench seat will engage securely is to always keep the seat anchorages clean and free of foreign objects. Always observe the notes about the seating variants (> page 86).

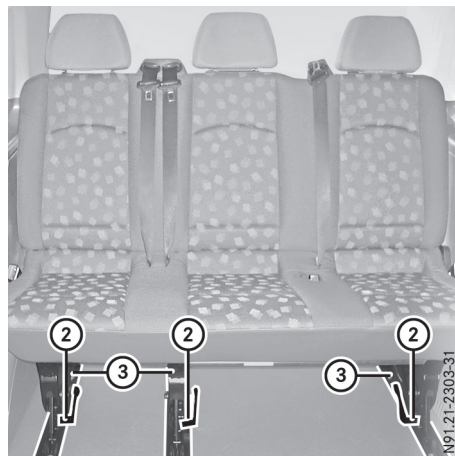
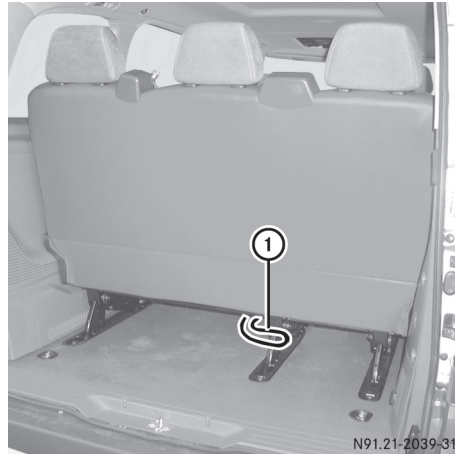

- ① Release handle for rear seat anchorage
- ② Release handle for front seat legs
- ③ Seat anchorages

- ▶ **To remove:** fold release handle for rear seat anchorage ① up.
- ▶ Tilt the rear bench seat forward by the upper edge of the seat backrest.
- ▶ Pull release handle for front seat legs ② up.
- ▶ Hold the rear bench seat by the lower edge of the seat cushion.
- ▶ Fold the rear bench seat forwards and pull it out of seat anchorages ③.

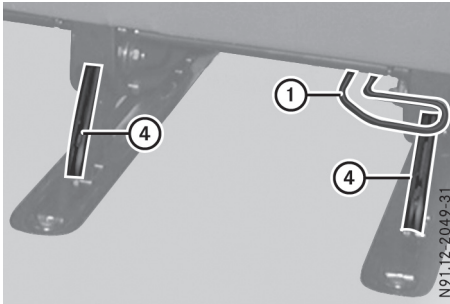

- ▶ **To install:** hold the rear bench seat by the lower edge of the seat cushion.
- ▶ Guide the rear bench seat from the front down into front seat anchorages ③ and allow it to engage.
- ▶ Make sure that release handles ② are folded underneath in the direction of the floor of the vehicle.
- ▶ Fold the rear bench seat back into the upright position.

The rear seat legs of the rear bench seat have engaged correctly if:

- the seat legs engage audibly
- indicator tabs ④ on the seat legs are no longer visible and have retracted fully into the seat legs

If the rear seat legs of the rear bench seat have not engaged correctly:

- ▶ Press release lever for rear seat legs ① down until indicator tabs ④ have fully retracted into the rear seat legs.

If the rear seat legs of the rear bench seat have not engaged correctly again:

- ▶ Fold the rear bench seat back again with force so that the seat legs engage correctly.

Head restraints

Important safety notes

⚠ WARNING

You could lose control of your vehicle if you do the following while driving:

- adjust the driver's seat, head restraint, steering wheel or mirrors
- fasten the seat belt

There is a risk of an accident.

Adjust the driver's seat, head restraint, steering wheel and mirror and fasten your seat belt before starting the engine.

⚠ WARNING

If the head restraints are not installed or not adjusted correctly, they cannot provide protection as intended. There is an increased risk of injury in the head and neck area, e.g. in the event of an accident or when braking.

Always drive with the head restraints installed. Before driving off, make sure for every vehicle occupant that the center of the head restraint supports the back of the head at about eye level.

Adjust the head restraint so that:

- the center of the head restraint supports the back of the head at eye level and the head restraint is engaged
- when your head is relaxed the back of your head rests as close as possible to the head restraint

Adjusting the head restraints

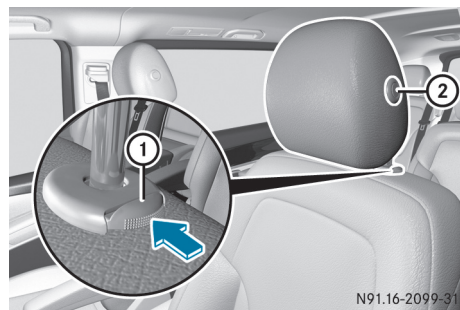

- ▶ **To raise:** pull the head restraint up to the desired position.
- ▶ **To lower:** press release button ① and slide head restraint down to the desired position.
- ▶ **To move the driver's or front-passenger head restraint forward:** pull the head restraint forward until it engages in the desired position.
- ▶ **To move the driver's or front-passenger head restraint back:** press and hold down

release knob ② and slide the head restraint back to the desired position.

- ▶ Let go of release button ②.
- ▶ Ensure that the head restraint has engaged properly.

The head restraints can be removed and installed as follows:

- ▶ **To remove:** pull the head restraint up to the stop.
- ▶ Press release button ① and pull out the head restraint.
- ▶ **To insert:** insert the head restraint so that the rod with the detents is on the left when viewed in the direction of travel.
- ▶ Push the head restraint down until it engages.

Armrests

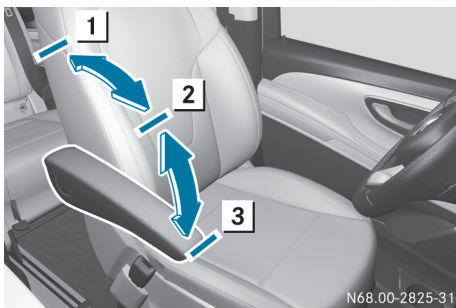

- ▶ **To adjust the armrest angle:** fold the armrest up by more than 45° to position ②. The armrest is released.
- ▶ Fold armrest ③ forward to the stop.
- ▶ Slowly fold the armrest up to the desired position.
- ▶ **To fold the armrest up:** if necessary, fold the armrest up by more than 90° to position ①.

Seat heating

WARNING

Repeatedly switching on the seat heating can cause the seat cushion and backrest pads to become very hot. The health of persons with limited temperature sensitivity or a limited ability to react to high temperatures may be

affected or they may even suffer burn-like injuries. There is a risk of injury.

Therefore, do not switch the seat heating on repeatedly.

- ▶ **!** When you leave your seat, do not place anything on the seat and switch off the seat heating. Do not switch the seat heating on when the seat is not occupied, e.g. when driving without a front passenger. The seat heating may otherwise overheat, causing damage to the seat.

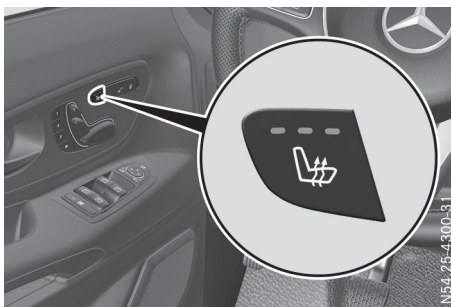



The three red indicator lamps in the  button show the activated heating level 1 to 3.

The seat heating automatically switches down from level 3 to level 2 after approximately seven minutes.

The system automatically switches down from level 2 to level 1 after approximately ten minutes.

At level 1 the seat heating switches off automatically after approximately 20 minutes.

- ▶ Make sure that the key is in position 1 or 2 in the ignition lock.
- ▶ **To switch on:** press the  button repeatedly until the desired heating level has been set.
- ▶ **To switch off:** press the  button repeatedly until all indicator lamps go out.

If the on-board voltage is too low, the seat heating will either switch itself off prematurely or not come on at all. In this case, too many electrical consumers are switched on or the battery charge is not sufficient. The seat heating will automatically switch back to the current heating level when enough on-board voltage is available again.

Steering wheel

WARNING

You could lose control of your vehicle if you do the following while driving:

- adjust the driver's seat, head restraint, steering wheel or mirrors
- fasten the seat belt

There is a risk of an accident.

Adjust the driver's seat, head restraint, steering wheel and mirror and fasten your seat belt before starting the engine.

WARNING

If the steering wheel is unlocked while the vehicle is in motion, it could change position unexpectedly. This could cause you to lose control of the vehicle. There is a risk of an accident.

Before starting off, make sure the steering wheel is locked. Never unlock the steering wheel while the vehicle is in motion.

WARNING

Children could injure themselves if they adjust the steering wheel. There is a risk of injury.

When leaving the vehicle, always take the SmartKey with you and lock the vehicle. Never leave children unsupervised in the vehicle.

The steering wheel can still be adjusted if the key has been removed.

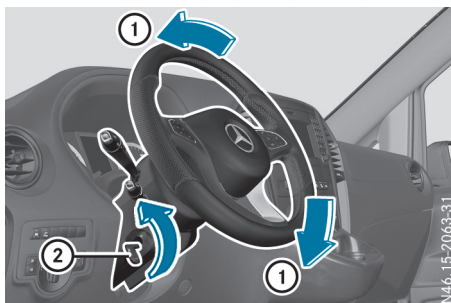

Adjusting the steering wheel

- ① Steering column height
- ② Lever

- ▶ **To adjust the steering wheel:** pull lever ② up and hold it.
The steering wheel is unlocked.
- ▶ Move the steering wheel to the desired position.
- ▶ Let go of lever ②.
The steering wheel engages and is locked again.

Mirrors

Important safety notes

WARNING

You could lose control of your vehicle if you do the following while driving:

- adjust the driver's seat, head restraint, steering wheel or mirrors
- fasten the seat belt

There is a risk of an accident.

Adjust the driver's seat, head restraint, steering wheel and mirror and fasten your seat belt before starting the engine.

WARNING

The exterior mirror on the front-passenger side reduces the size of the image. Visible objects are actually closer than they appear. This means that you could misjudge the distance from road users traveling behind, e.g. when changing lane. There is a risk of an accident.

For this reason, always make sure of the actual distance from the road users traveling behind by glancing over your shoulder.

Rear-view mirror

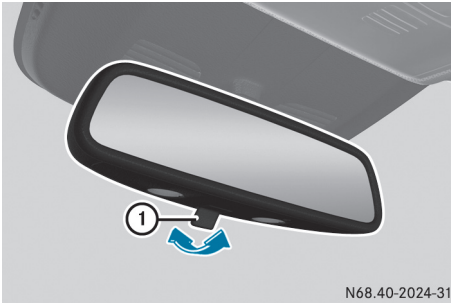

- ▶ **Anti-glare mode:** push anti-glare lever ① forwards or back.

Exterior mirrors

Adjusting manually

- ▶ Before starting off, manually adjust the exterior mirrors in such a way that you can get a good overview of road and traffic conditions.

Adjusting electrically

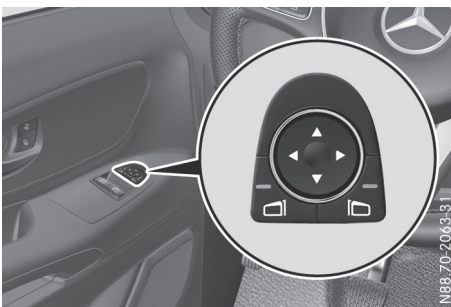

- ▶ Before pulling away, turn the key to position **1** or **2** in the ignition lock.
- ▶ Press the button for the left exterior mirror or the button for the right exterior mirror. The indicator lamp for the button switches on and the selected exterior mirror can be adjusted. The indicator lamp goes out again after some time.
- ▶ If the indicator lamp for button or lights up, press adjustment button up or down, to the right or left. Adjust the exterior mirrors in such a way that you have a good overview of traffic conditions.

After the engine has been started, the exterior mirrors are automatically heated if the rear window defroster is switched on and the outside temperature is low.

Disengaged exterior mirrors

If an exterior mirror has been pushed out of position, proceed as follows:

- ▶ Move the exterior mirror into the correct position manually. The mirror housing engages again and the exterior mirrors can be adjusted again as usual.

Exterior mirror heating

- ▶ **Information Vehicles without rear window defroster:** when the temperature is below 15 °C the mirror heating switches on automatically after engine start and remains on.
- ▶ **Information Vehicles with rear window defroster:** at temperatures below 15 °C, the mirror heating switches on automatically after engine start for 10 min. In addition, mirror heating can be switched on together with the rear window defroster.
- ▶ **To switch the mirror heating on manually:** turn the key to position **2** in the ignition lock.
- ▶ Press the button on the control panel. If the indicator lamp in the button lights up, both the mirror heating and the rear window defroster are switched on.

The rear window defroster switches off automatically after a few minutes.

Useful information

This Operator's Manual describes all models as well as standard and optional equipment of your vehicle that were available at the time of going to print. Country-specific variations are possible. Note that your vehicle may not be equipped with all of the described functions. This also applies to systems and functions relevant to safety.

Read the information on qualified specialist workshops (▷ page 31).

Exterior lighting

Important safety notes

For reasons of safety, Mercedes-Benz recommends that you drive with the lights switched on even during the daytime. There may be differences in operation due to legal requirements and voluntary recommendations in some countries.

Light switch

Operation

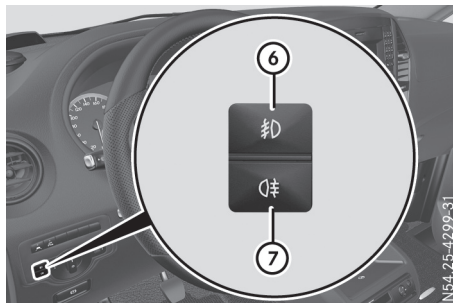
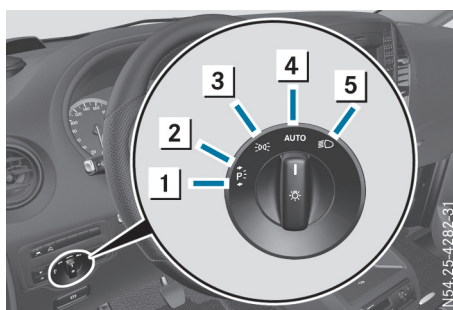

- 1 Left-hand standing lamps
- 2 Right-hand standing lamps
- 3 Parking lamps, license plate and instrument cluster lighting
- 4 Lights off and daytime running lamps
AUTO With light sensor: automatic headlamp mode, controlled by the light sensor
- 5 Low-beam or high-beam headlamps
- 6 Front fog lamp
- 7 Rear fog lamp

If you hear a warning tone when you leave the vehicle, the lights may still be switched on.



- Turn the light switch to the **0** or **AUTO** position.

The exterior lighting (except the parking lamps and standing lamps) switches off automatically if you:

- remove the key from the ignition lock
- open the driver's door with the key in position **0** in the ignition lock

Low-beam headlamps

When the ignition is switched on and the light switch is in the  position, the parking lamps and low-beam headlamps are switched on even if the light sensor does not sense dark ambient light. This is particularly useful when there is fog or rain.

- ▶ **To switch on:** turn the key to position **2** in the ignition lock or start the engine.
- ▶ Turn the light switch to the  position. The  indicator lamp in the instrument cluster lights up.

Daytime running lamps

- ▶ **To switch on:** turn the light switch to the  or **AUTO** position.

Automatic headlamp mode



WARNING

When the light switch is set to **AUTO**, the low-beam headlamps may not be switched on automatically if there is fog, snow or other causes of poor visibility due to the weather conditions such as spray. There is a risk of an accident.

In such situations, turn the light switch to



Automatic headlamp mode is only a driving aid. You are responsible for the vehicle lighting at all times.

When the parking lamps and low-beam headlamps are switched on, the green  (parking lamps) and  (low-beam headlamps) indicator lamps in the instrument cluster light up.

AUTO is the preferred light switch setting. The light setting is automatically selected according to the brightness of the ambient light (exception: poor visibility due to weather conditions, such as fog, snow or spray):

- Key in position **1** in the ignition lock: the standing lamps are switched on or off automatically depending on the brightness of the ambient light.
- When the engine is on: depending on the ambient light, the daytime running lamps or the parking lamps and low-beam headlamps are switched on/off automatically.





- ▶ **To switch on automatic headlamp mode:** turn the light switch to **AUTO**.

Fog lamps/rear fog lamp



You can only switch the fog lamps on or off manually in vehicles which have fog lamps installed.

Front fog lamps help you to see and be seen in conditions of poor visibility due to fog or precipitation. They can only be operated together with the parking lamps or with the low-beam headlamps.

The rear fog lamp improves visibility of your vehicle for the traffic behind in the event of heavy fog. Observe the legal requirements of the country you are currently in when using the rear fog lamp.

- ▶ Turn the light switch to  or **AUTO**.
- ▶ Turn the key to position **2** in the ignition lock or start the engine.
- ▶ **To switch the front foglamps on/off:** press the  button. When the green  indicator lamp in the instrument cluster goes on, the fog lamps are switched on.
- ▶ **To switch the rear foglamp on/off:** press the  button. When the yellow  indicator lamp in the instrument cluster goes on, the rear fog lamp is switched on.

Standing lamps

- ! If the battery charge is very low, the standing lamps will switch off automatically to enable the next engine start. Always park your vehicle in accordance with legal regulations, in a secure and adequately lit location. Avoid leaving the  parking lamps on for several hours. If possible, switch on the right  or left  standing lamp.

Switching on the standing lamps ensures that the corresponding side of the vehicle is illuminated.

Switching on the standing lamps:

- ▶ Turn the key to position **0** (▶ page 121) in the ignition lock or remove the key.
- ▶ **Right-hand standing lamp:** turn the light switch to position **P←→**.
- ▶ **Left-hand standing lamp:** turn the light switch to position **←P**.

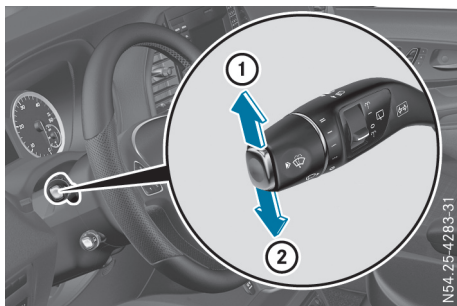
Combination switch**Turn signal lamps**

- ① To indicate a right turn
- ② To indicate a left turn

- ▶ **To indicate:** press the combination switch in desired direction ① or ② until it engages. The combination switch automatically returns to its original position after large steering movements.
- ▶ **To indicate briefly:** press the combination switch briefly in desired direction ① or ②. The corresponding turn signal flashes three times.

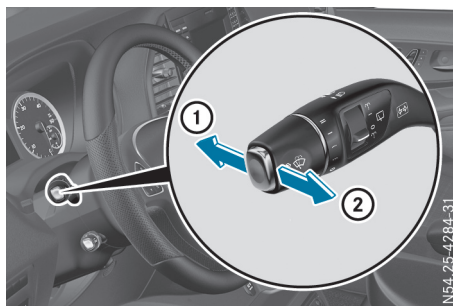
High-beam headlamps and high-beam flasher

- ① High-beam headlamps
- ② High-beam flasher

- ▶ **To switch on the high-beam headlamps:** turn the light switch to or **AUTO**.
- ▶ Press the combination switch forwards ①. The indicator lamp in the instrument cluster lights up.
 - ⓘ In the **AUTO** position, the high-beam headlamps are only switched on when it is dark and the engine is running.
- ▶ **To switch off the high-beam headlamps:** move the combination switch back to its normal position. The indicator lamp in the instrument cluster goes out.
- ▶ **To operate the headlamp flasher:** turn the key to position **1** or **2** in the ignition lock.
- ▶ Pull the combination switch briefly in direction of arrow ②.

Hazard warning lamps **WARNING**

If you open the rear doors 90°, the rear lights are no longer visible. The vehicle will then be difficult for other road users to see or will not be seen by them at all, particularly if it is dark or visibility is poor. There is a risk of an accident.

You should therefore ensure in this and similar situations that the vehicle is visible from the rear in accordance with the relevant national regulations, by using the warning triangle, for instance.

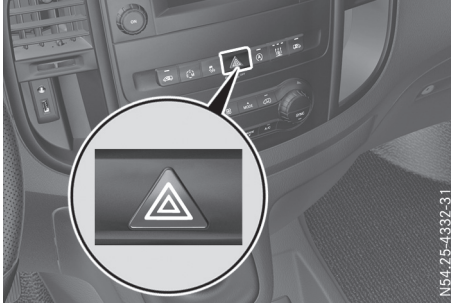

Hazard warning lamp switch

► **To switch on/off:** press the  hazard warning lamp switch.

If you have indicated a turn while the hazard warning lamps are switched on, only the turn signal lamps on the side of the vehicle selected will light up.

The hazard warning lamps automatically switch on if:

- an air bag is deployed.
- you brake sharply and bring the vehicle to a halt from a speed of more than 45 mph (70 km/h).

The hazard warning lamps switch off automatically if the vehicle reaches a speed of over 6 mph (10 km/h) again after a full brake application.

i The hazard warning lamps still operate even if the ignition is switched off.

Headlamps fogged up on the inside

The headlamps may fog up on the inside if there is high atmospheric humidity.

► Switch on the low-beam headlamps and drive off.
The level of moisture diminishes, depending on the length of the journey and the weather conditions (humidity and temperature).

If the level of moisture does not diminish:



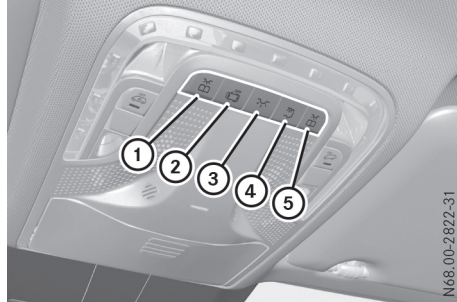

► Have the headlamps checked at a qualified specialist workshop.

Interior lighting

Overview



Interior lighting buttons (example: comfort overhead control panel)

- ①  Switches the front left-hand reading lamp on/off
- ②  Switches the automatic interior lighting control on and off
- ③  Switches the front interior lighting on and off
- ④  Switches the rear or cargo compartment lighting on/off
- ⑤  Switches the front right-hand reading lamp on and off

The number and arrangement of the buttons is equipment-dependent.

General notes

In order to prevent the vehicle's battery from discharging, the interior lighting functions are automatically deactivated after some time, unless the key is in position **2** in the ignition lock.

Automatic interior lighting control

The interior lighting is activated for about 20 seconds when the key is removed from the ignition lock. For a vehicle with steering wheel buttons, the light delay function for the interior lighting can be switched on and off using the on-board computer (► page 188).

- ▶ **To switch on or off:** press the  button. When the automatic interior lighting control is activated, the button is flush with the overhead control panel.

The interior lighting switches on automatically if you:



- unlock the vehicle
- open a door
- remove the key from the ignition lock

The cargo compartment lamp switches on automatically if you:

- unlock the vehicle
- open the tailgate or rear door
- open a sliding door

The trunk lamp always switches on automatically when the tailgate is opened.

Manual interior lighting control

- ▶ **To switch the front interior lighting on/off:** press the  button.
- ▶ **To switch the rear or cargo compartment lighting on/off:** press the  button.
- ▶ **To switch the front reading lamps on/off:** press the  button.

Rear interior light with reading lamp in the handles

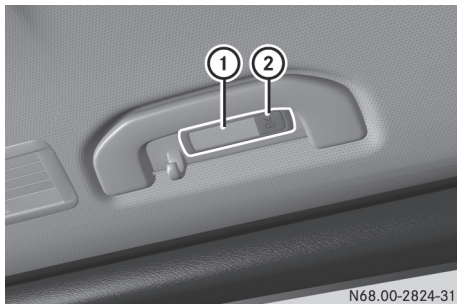

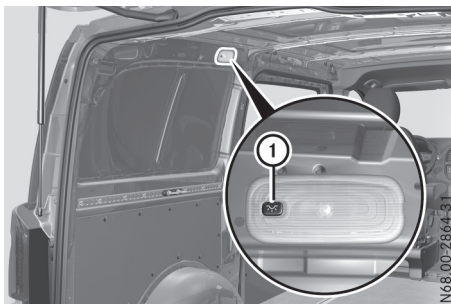

- ① Rear interior light and reading lamp
- ② Switches the reading light on and off

Cargo compartment lamp with button



Cargo compartment lamp with button

- ①  Switches the cargo compartment lighting on/off

If your vehicle is installed with a cargo compartment lamp with a button, you can switch all the cargo compartment lamps on/off using the  button in this cargo compartment lamp.

Regardless of the position of the switch, the cargo compartment lighting can be switched on/off centrally using the  button in the overhead control panel (▷ page 97).

Replacing bulbs: interior lighting and ambient lamps

General notes

It is essential that the important safety notes on changing light bulbs are observed (▷ page 100).

Have the bulbs of the following interior lights replaced at a qualified specialist workshop only:

- lights for the footwell lighting
- lights for the overhead control panel in the dashboard
- lamps in the rear compartment grab handles
- the trunk lamp in the headliner in a Passenger Van
- LED light strip in the cargo compartment in a Cargo Van

Otherwise, the lamps, their brackets or the side paneling and headliner may be damaged.

If you require help when changing bulbs of other interior lights, please visit a qualified specialist workshop.

Rear compartment and cargo compartment lamps

You cannot change the following bulbs yourself:

- in a Passenger Van, the bulbs in the trunk lamp and those of the rear interior lights in the grab handles
- in a Cargo Van with an LED light strip in the cargo compartment, the LED light strip

Have these bulbs or the LED light strip changed in a qualified specialist workshop only.

Information on changing the bulb of the trunk lamp in the side trim panel of vehicles with a cargo compartment stowage tray can be found under "Additional interior and ambient lighting" (▷ page 99)

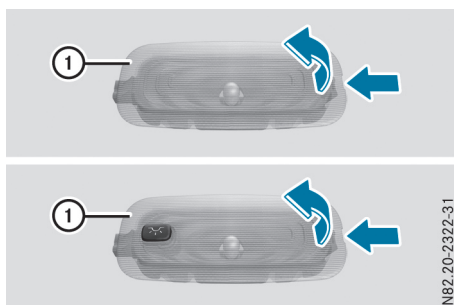

Rear interior and cargo compartment lamp in the headliner or side trim panel

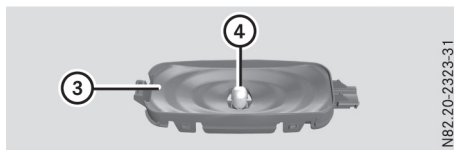
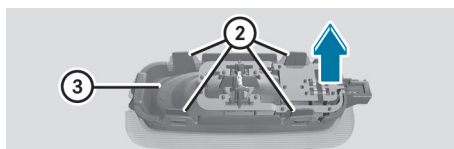

Bulb type: T10 6W Xenon

- ▶ Switch off the interior lighting.
- ▶ Press in the spring catch of lamp lens (1) with a suitable object, e.g. a screwdriver, and then pry off lamp lens (1) with lamp housing (3).
- ▶ Press in spring catches (2) and pull lamp lens (1) off from lamp housing (3).
- ▶ Remove bulb (4) from lamp housing (3).
- ▶ Insert new bulb (4).

- ▶ For cargo compartment lamps with a button, align lamp lens (1) so that its opening is above the button of lamp housing (3).
- ▶ Position lamp lens (1) on lamp housing (3) and engage.
- ▶ Position lamp lens (1) with lamp housing (3) on the left and engage.

Additional interior lighting and surround lighting

The scope of the additional interior and ambient lighting depends on your vehicle equipment. The bulb change described here is valid for:

- the mirror lamp in the sun visor
- the ambient lamp at the bottom of the front door
- the ambient lamp inside the tailgate

You can find information on changing the bulb of the signal and ambient lamp at the bottom of the tailgate under "Signal and ambient lamp in the tailgate" (▷ page 100).

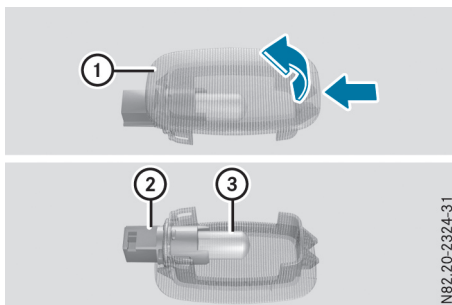

Type of lamp: W 5 W

- ▶ Press in the spring catch of lamp housing (1) with a suitable object, e.g. a screwdriver, and pry off lamp housing (1).
- ▶ Turn socket (2) anti-clockwise and remove from the lamp housing (1).
- ▶ Remove bulb (3) from socket (2).
- ▶ Press new bulb (3) into socket (2).
- ▶ Screw socket (2) clockwise into the lamp housing (1).
- ▶ Position lamp housing (1) on the left-hand side and engage.

Signal and ambient light in the tail-gate

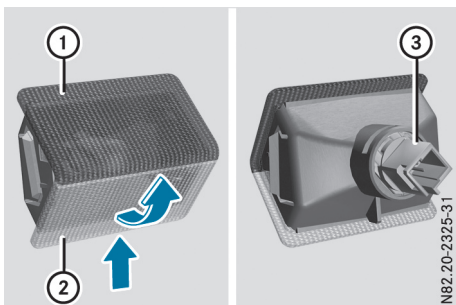

Type of lamp: W 5 W

- ▶ Press in the spring catch of the lamp housing at the side of crystal clear lamp lens (2) with a suitable object, e.g. with a screwdriver, and prise off the lamp housing.
- ▶ Turn socket (3) anti-clockwise and remove from the lamp housing.
- ▶ Remove the bulb from socket (3).
- ▶ Press the new bulb into socket (3).
- ▶ Screw socket (3) clockwise into the lamp housing.
- ▶ Position the lamp housing to the side of red lamp lens (1) and engage.

Replacing bulbs

Important safety notes

WARNING

Bulbs, lamps and connectors can get very hot when operating. If you change a bulb, you could burn yourself on these components. There is a risk of injury.

Allow these components to cool down before changing a bulb.

- ❗ Make sure the bulbs are always securely installed.

The bulbs and lamps are an essential component of vehicle safety. You must therefore make sure that these function correctly at all times. Have the headlamp setting checked regularly.

- Always switch off the ignition before replacing bulbs in the lighting system. This will prevent a short circuit.
 - Wear gloves and eye protection when changing a bulb.
 - Do not use a bulb that has been dropped or that has scratches on its glass tube. The bulb could may explode.
 - A bulb could explode if:
 - you touch it
 - it is hot
 - you drop it
 - you scratch or score it
 - Marks on the glass tube shorten the operating life of a bulb. Do not touch the glass tube with your bare hands. If necessary, clean the glass tube when cold with alcohol or spirit. Then rub off the glass tube with a clean, lint-free cloth.
 - Make sure that bulbs are protected from moisture when operating and that they do not come into contact with liquids. Make sure that seals are seated correctly and replace damaged seals.
 - Check the contacts for signs of corrosion and clean these if required.
 - Only operate bulbs in closed lamps which have been designed for this purpose.
 - Only use spare bulbs of the same type, with the prescribed voltage and the correct wattage.
 - If the new bulb does not light up, consult a qualified specialist workshop.
 - Have lamps with LED bulbs repaired at a qualified specialist workshop only.
 - Have the bulbs of the following lamps replaced at a qualified specialist workshop only:
 - the additional brake lamps
 - the license plate lighting
 - Front fog lamps
 - side marker lamp
- Please also observe the notes on the interior lights (▷ page 98).

If you require assistance changing bulbs, consult a qualified specialist workshop.

Front lamp clusters

Overview of bulb types



	Lights	Bulb type
①	Side-mounted additional turn signal lamp	WY 5 W
②	Turn signal lamp	PY 21 W
③	Low-beam headlamp	H7 55 W
④	Front fog lamp	H11 55 W
⑤	High-beam headlamp/ parking lamp/standing lamp/daytime running lamp	H15 55 W/ 15 W
⑥	Side marker lamp	LED

Installing/removing the cover on the front wheel arch



- ▶ **To remove:** switch off the lighting system.
- ▶ To change a bulb set in the left headlamp, turn the steering wheel clockwise as far as it will go. To change a bulb in the right headlamp,

turn the steering wheel counter-clockwise as far as it will go.

The space in front of the cover in the front wheel arch then becomes greater.

- ▶ Grip cover ① in the middle.
- ▶ Slide cover ① upwards, remove and let it hang from the strap.
- ▶ **To install:** if necessary, remove dirt from cover ① and the opening in the wheel arch.
- ▶ Insert cover ① at the top and thread the cover strap through the opening in the wheel arch.
- ▶ Slide cover ① down as far as it will go.

Low-beam headlamps

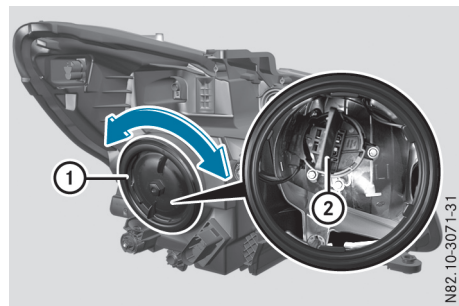

View from inside (example: left headlamp)

- ▶ Remove the cover in the front wheel arch (▷ page 101).
- ▶ Turn housing cover ① counter-clockwise and remove it.
- ▶ Turn socket ② for low-beam headlamps counter-clockwise and remove it.
- ▶ Remove the bulb from socket ②.
- ▶ Insert a new bulb into socket ②.
- ▶ Insert socket ② and tighten by turning clockwise.
- ▶ Press on housing cover ① and tighten by turning clockwise.
- ▶ Replace the cover in the front wheel arch (▷ page 101).

High-beam headlamps, parking lamps/ standing lamps and daytime running lamps

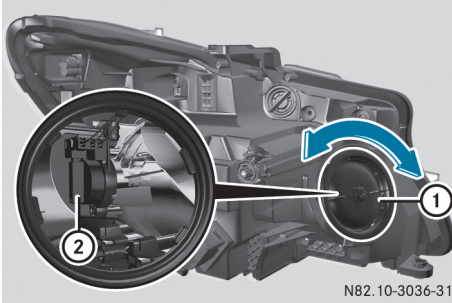

View from inside (example: left headlamp)

- ▶ Switch off the lighting system.
- ▶ Open the hood.
- ▶ Turn housing cover ① counter-clockwise and remove it.
- ▶ Pull out the bulb together with bulb holder ②.
- ▶ Insert the new bulb with bulb holder ② and engage it as far as it will go.
- ▶ Press on housing cover ① and turn clockwise to fasten.
- ▶ Close the hood.

Turn signal lamp

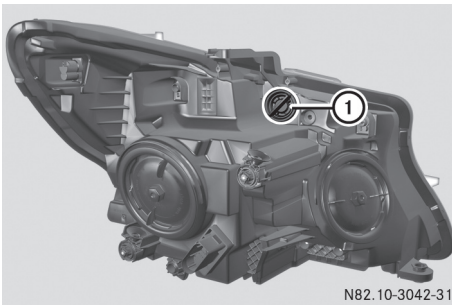

View from inside (example: left headlamp)

- ▶ Switch off the lighting system.
- ▶ Open the hood.
- ▶ Turn socket ① anti-clockwise and remove.
- ▶ Pull bulb out of socket ①.
- ▶ Insert a new bulb into socket ①.

- ▶ Insert socket ① and turn it clockwise until it engages.
- ▶ Close the hood.

Side-mounted additional turn signal lamp

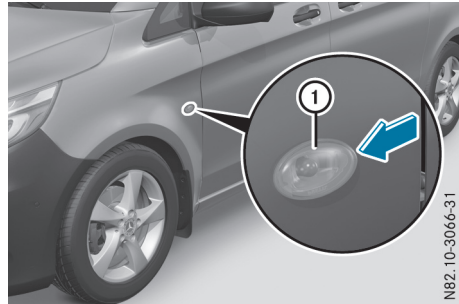

The additional turn signals are mounted on the side of the vehicle's front fender.

- ▶ Switch off the lighting system.
- ▶ Slide additional turn signal ① forwards and swing it out.
- ▶ Press the bulb to the rear.
- ▶ Apply light pressure to the bulb, turning it anti-clockwise and remove it from the socket.
- ▶ Press the new bulb into the socket and screw it in clockwise.
- ▶ Attach additional turn signal ① at the front and engage.

Replacing the rear lamp clusters

Overview of bulb types

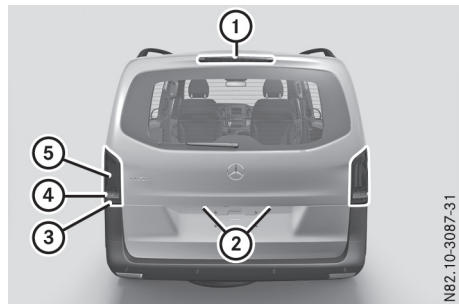

Tail lamps

	Lights	Bulb type
①	High-mounted brake lamp	LED
②	License plate lamp	LED
③	Rear fog lamp (driver's side)	P 21 W
④	Backup lamp	P 21 W
⑤	Brake lamp/tail lamp/standing lamp/turn signal	P 21 W
	Side marker lamp	LED

Tail lamps

Installing/removing the tail lamp

! Remove the tail lamps with care so as not to damage the paintwork.

Because of the installation position, Mercedes-Benz recommends that you have the tail lamp bulbs changed at a qualified specialist workshop.

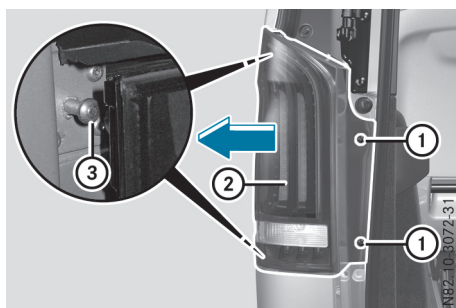

Tail lamp

- ▶ **To remove:** switch off the lighting system.
- ▶ Open the tailgate/rear door.
- ▶ **i** The vehicle tool kit contains a screwdriver (> page 270).
- ▶ Unscrew two side screws ①.
- ▶ Press tail lamp ② out as far as bolts ③.
- ▶ Remove tail lamp ② out from bolts ③.
- ▶ Pull the connector off the bulb holder of the tail lamp.
- ▶ **To install:** press the connector into the bulb holder of the tail lamp.

- ▶ Press the tail lamp sideways onto bolts ③ and slide onto the vehicle.
- ▶ Tighten two side screws ①.

Standard tail lamp

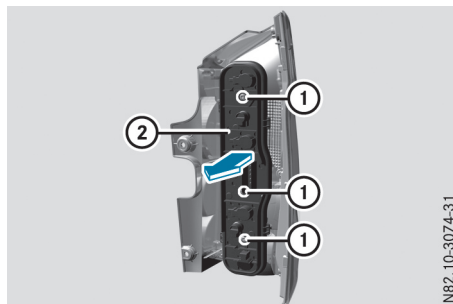

- ▶ Remove the tail lamp (> page 103).
- ▶ Unscrew three screws ① and remove bulb holder ② from the tail lamp.

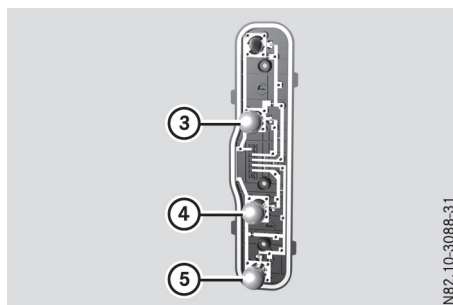

Bulb holder

- ③ Turn signals/brake lamps/tail lamps/standing lamps
- ④ Backup lamps
- ⑤ Rear fog lamp (driver's side only)
- ▶ Apply light pressure to the corresponding bulb, turn it counter-clockwise and remove it from the bulb holder.
- ▶ Press the new bulb into the socket and screw it in clockwise.
- ▶ Insert bulb holder ② into the tail lamp and tighten all three screws ①.
- ▶ Install the tail lamp (> page 103).

Windshield wipers

Switching the windshield wiper on/off

! Do not operate the windshield wipers when the windshield is dry, as this could damage the wiper blades. Moreover, dust that has collected on the windshield can scratch the glass if wiping takes place when the windshield is dry.

If it is necessary to switch on the windshield wipers in dry weather conditions, always use washer fluid when operating the windshield wipers.

! If the windshield wipers leave smears on the windshield after the vehicle has been washed in an automatic car wash, wax or other residues may be the reason for this. Clean the windshield using washer fluid after washing the vehicle in an automatic car wash.

! Intermittent wiping with rain sensor: due to optical influences and the windshield becoming dirty in dry weather conditions, the windshield wipers may be activated inadvertently. This could then damage the windshield wiper blades or scratch the windshield.

For this reason, you should always switch off the windshield wipers in dry weather.

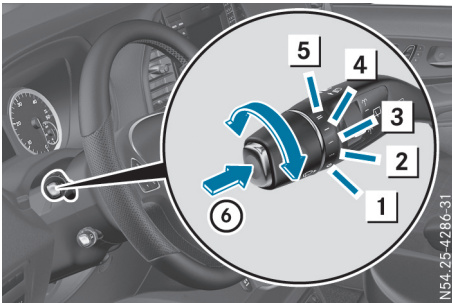

- 1 0 Windshield wipers off
- 2 ... Intermittent wipe, low (rain sensor set to low sensitivity)
- 3 Intermittent wipe, high (rain sensor set to high sensitivity)
- 4 — Continuous wipe, slow
- 5 == Continuous wipe, fast
- 6 1st pressure point – single wipe; 2nd pressure point – wipe with washer fluid

- ▶ Turn the key to position **1** or **2** in the ignition lock.
- ▶ Turn the wiper switch to the corresponding position.

In the or positions, the appropriate wiping frequency is set automatically according to the intensity of the rain. In the position, the rain sensor is more sensitive to precipitation than in the position, causing the windshield wipers to wipe more frequently.

The windshield will no longer be wiped properly if the wiper blades are worn. This may prevent you from observing the traffic conditions. Information on replacing the wiper blades can be found under "Replacing wiper blades" (> page 105).

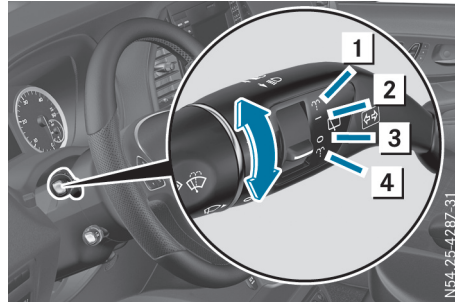

Switching the rear window wiper on/off



- 1 To wipe with washer fluid
- 2 — Intermittent wipe
- 3 0 Rear window wiper off
- 4 To wipe with washer fluid

- ▶ Turn the key to position **1** or **2** in the ignition lock.
- ▶ Move the switch to the corresponding position.
If the rear window wiper is activated, the symbol is shown in the status area of the display.

The **Status Overview** in the **Assist.** menu then also shows the  symbol for vehicles with steering wheel buttons (> page 184).

- ▶ **To wipe with washer fluid:** press the  switch beyond the current position as far as it will go to **1** or press and hold **4**. When you release the  switch, the rear window wiper continues to wipe for about another five seconds. The rear window wiper then wipes according to the original position **2** or **3**.

The rear window wiper switches on automatically if you engage reverse gear and the windshield wipers are on.

If the vehicle is stationary and you open the tailgate or rear door, the rear window wiper will stop automatically. The rear window wiper will only resume wiping again when the tailgate and rear door are closed and you pull away again.

The rear window will no longer be wiped properly if the wiper blade is worn. This may prevent you from observing the traffic conditions. Information on replacing the wiper blade can be found under "Replacing wiper blades" (> page 105).

Replacing the wiper blades

Important safety notes

WARNING

If the windshield wipers begin to move while you are changing the wiper blades, you could be trapped by the wiper arm. There is a risk of injury.

Always switch off the windshield wipers and ignition before changing the wiper blades.

- ❗ Never open the hood/tailgate or rear doors if a windshield wiper arm has been folded away from the windshield/rear window.

Never fold a windshield wiper arm without a wiper blade back onto the windshield/rear window.

Hold the windshield wiper arm firmly when you change the wiper blade. If you release the windshield wiper arm without a wiper blade and it falls onto the windshield/rear window, the windshield/rear window may be damaged by the force of the impact.

Mercedes-Benz recommends that you have the wiper blades changed at a qualified specialist workshop.

- ❗ Only hold the wiper blade by the wiper arm. You could otherwise damage the wiper rubber.

Wiper blades are wear parts. The windshield will no longer be wiped properly if the wiper blades are worn. This may prevent you from observing the traffic conditions.

Please observe the service indicator after changing the wiper blades of the windshield wiper.

Service indicator

Replacement wiper blades for the windshield wiper have a service indicator on the tip of the wiper blade.

Depending on the amount of use, the service indicator will change color from black to yellow. Change the wiper blade if:

- the wiper blade is damaged
- the service indicator has turned yellow

In order to activate the service indicator, you have to remove the protective film (> page 105).

Windshield wipers

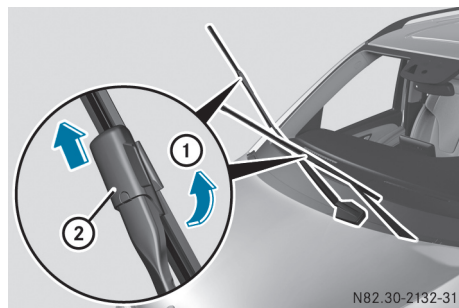

- ▶ Fold out wiper arm away from the windshield.
- ▶ Hold the wiper arm and turn the wiper blade in the direction of arrow **1** away from the wiper arm as far as it will go.
- ▶ Slide catch **2** upwards in the direction of the arrow until you can feel and hear it engage in the changing position.

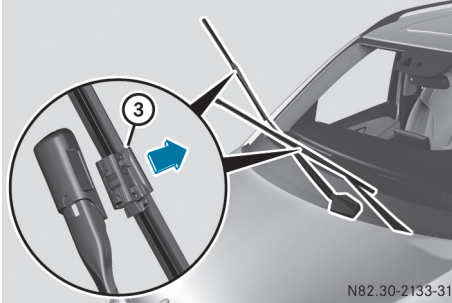

- ▶ Remove wiper blade ③ from wiper arm by pulling it in the direction of the arrow.

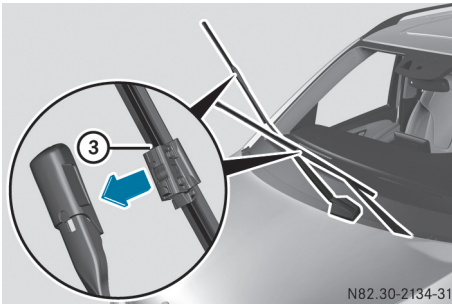

- ▶ Insert new wiper blade ③ into the wiper arm in the direction of the arrow.

Please take the differing lengths of the two wiper blades into account:

- Driver's side - long wiper blade
- Front-passenger side - short wiper blade

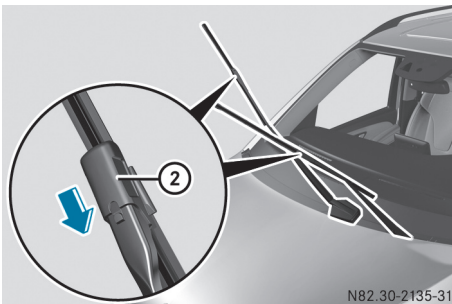

- ▶ Slide catch ② downwards in the direction of the arrow until you can feel and hear it engage.
- ▶ Fold the wiper arm back onto the windshield.

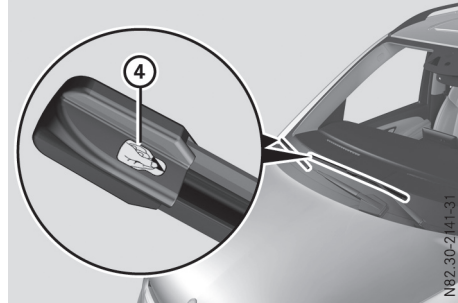

- ▶ Remove protective film ④ from the service indicator on the tip of the wiper blades.

Rear window wiper

Tailgate

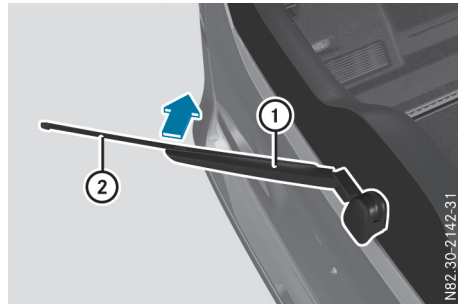

- ▶ Fold wiper arm ① away from the rear window until you hear it engage.
- ▶ Hold wiper arm ① and pull wiper blade ② in the direction of the arrow away from the wiper arm.
- ▶ Place new wiper blade ② onto wiper arm ①.
- ▶ Hold wiper arm ① and push wiper blade ② in the opposite direction to the arrow until it engages.
- ▶ Make sure that wiper blade ② is in the correct position.
- ▶ Fold wiper arm ① back onto the rear window.

Rear doors

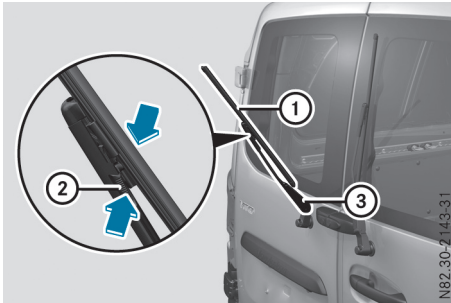

Rear window wipers (example: left rear door)

- ▶ Fold wiper arm (3) away from the rear window.
- ▶ Press both retaining clips (2) together in the direction of the arrow and swing wiper blade (1) away from wiper arm (3).
- ▶ Pull wiper blade (1) up and out of the retainer on wiper arm (3).
- ▶ Slide new wiper blade (1) into the retainer on wiper arm (3).
- ▶ Press new wiper blade (1) onto wiper arm (3) until you hear retaining clips (2) engage.
- ▶ Fold wiper arm (3) back onto the rear window.

Problems with the windshield wipers

Problem	Possible causes/consequences and ► Solutions
The windshield wiper jams.	Leaves or snow, for example, may be obstructing the windshield wiper movement. The wiper motor has switched off. <ul style="list-style-type: none"> ▶ Stop the vehicle as soon as possible, paying attention to road and traffic conditions. ▶ For safety reasons, you should remove the key from the ignition lock. ▶ Remove the cause of the obstruction. ▶ Switch on the windshield wipers again.
The windshield wiper does not move at all.	There is a malfunction in the windshield wiper drive. <ul style="list-style-type: none"> ▶ Select another wiper speed on the combination switch. ▶ Have the windshield wipers checked at a qualified specialist workshop.
The windshield washer fluid from the spray nozzles no longer hits the center of the windshield/rear window.	The spray nozzles are misaligned. <ul style="list-style-type: none"> ▶ Have the spray nozzles checked at a qualified specialist workshop.

Useful information

This Operator's Manual describes all models as well as standard and optional equipment of your vehicle that were available at the time of going to print. Country-specific variations are possible. Note that your vehicle may not be equipped with all of the described functions. This also applies to systems and functions relevant to safety.

Read the information on qualified specialist workshops (▷ page 31).

Overview of climate control systems

Important safety notes

Observe the recommended settings on the following pages. Otherwise, the windows could fog up.

To prevent the windows from fogging up:

- only switch off climate control briefly
- only switch on air-recirculation mode briefly
- for vehicles with air-conditioning system or dual-zone automatic climate control, switch on the "Cooling with air dehumidification" function
- for vehicles with dual-zone automatic climate control, switch on the windshield defrosting function briefly, if required

Climate control regulates the temperature and the humidity in the vehicle interior and filters undesirable substances from the air.

Climate control is only operational when the engine is running. The system only functions optimally when the side windows are closed.







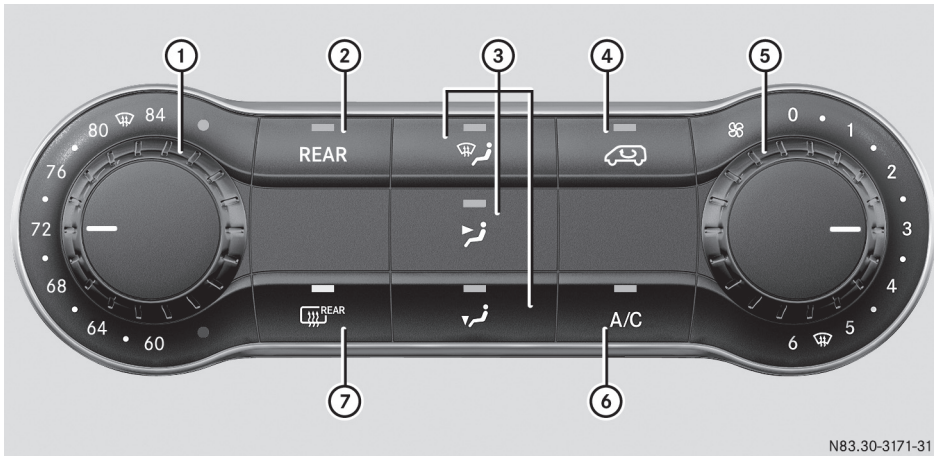

Ventilate the vehicle for a brief period during warm weather. In order to cool the vehicle more rapidly, switch climate control to air-recirculation mode briefly. This will speed up the cooling process and the desired interior temperature will be reached more quickly.

The integrated filter can filter out most particles of dust and completely filters out pollen. In vehicles with dual-zone automatic climate control, gaseous pollutants and odors will also be reduced. A clogged filter reduces the airflow into the vehicle interior. For this reason, you should always observe the interval for replacing the filter, which is specified in the Maintenance Booklet. As the interval between changes depends on environmental conditions, e.g. heavy air pollution, the interval may be shorter than stated in the Maintenance Booklet.

Control panel for the air-conditioning system





N83.30-3171-31

- ① Sets the temperature (▷ page 113)
- ②  Defrosts the windshield (▷ page 115)
- ③  Switches the rear-compartment air conditioning on/off (▷ page 111)
- ③  Sets the air distribution (▷ page 114)
- ③  Defrosts the windshield (▷ page 115)
- ④  Activates/deactivates air-recirculation mode (▷ page 116)
- ⑤  Sets the airflow (▷ page 114)
- ⑤  Defrosts the windshield (▷ page 115)
- ⑥  Switches the cooling with air dehumidification function on/off (▷ page 112)
- ⑦  Switches the rear window defroster and mirror heating on/off (▷ page 116)

Optimum use of the air-conditioning system

Below, you can find a number of notes and recommendations to help you use the air-conditioning system optimally.

- Switch on the cooling with air dehumidification function. The indicator lamp in the  switch comes on when the function is switched on.
- Set the temperature to 72 °F (22 °C). Only change the temperature in small increments.
- Only use the settings for defrosting the windshield briefly, until the windshield is clear again.
- Only use air-recirculation mode briefly, e.g. if there are unpleasant outside odors or when in

a tunnel. The windows could otherwise fog up as no fresh air is drawn into the vehicle in air-recirculation mode. The indicator lamp in the  switch comes on when the function is switched on.

During automatic engine switch-off, the climate control system only operates at a reduced capacity. Further information on the automatic engine switch-off can be found under "ECO start/stop function" (▷ page 123).

Control panel for dual-zone automatic climate control

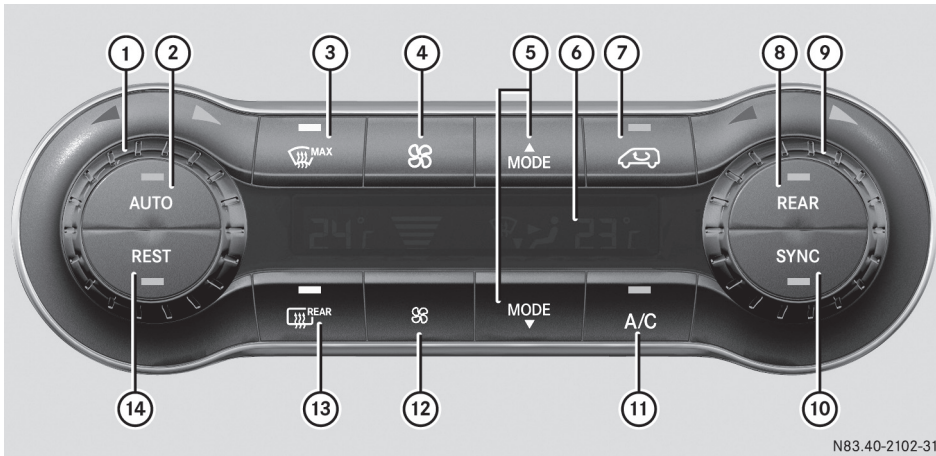

N83.40-2102-31

- ① Sets temperature to the left and at rear (only for vehicles with rear air conditioning) (▷ page 113)
- ② **AUTO** Activates automatic mode – controls the climate control automatically (▷ page 113)
- ③ **MAX** Defrosts the windshield (▷ page 115)
- ④ **FAN** Increases the airflow (▷ page 114)
- ⑤ **MODE** Sets the air distribution (▷ page 114)
- ⑥ Display
- ⑦ **RECIRC** Switches air-recirculation mode on or off (▷ page 116)
- ⑧ **REAR** Switches operation to rear air conditioning (2nd menu level) (▷ page 111)
- ⑨ Sets temperature to the right and at rear (only for vehicles with rear air conditioning) (▷ page 113)
- ⑩ **SYNC** Switches synchronization on or off (▷ page 115)
- ⑪ **A/C** Switches the cooling with air dehumidification function on or off (▷ page 112)
- ⑫ **FAN** Reduces the airflow (▷ page 114)
- ⑬ **REAR** Switches the rear window defroster and mirror heating on or off (▷ page 116)
- ⑭ **REST** Switches the residual heat utilization on or off (▷ page 117)

Optimum use of dual-zone automatic climate control

Below, you can find a number of notes and recommendations to help you use dual-zone automatic climate control optimally.

- Activate automatic mode. All basic functions are controlled automatically. The indicator lamp in the **AUTO** switch comes on when the function is switched on.
- Switch on the cooling with air dehumidification function. The indicator lamp in the **A/C** button comes on when the function is switched on.
- Set the temperature to 72 °F (22 °C) for both sides. Only change the temperature in small increments.
- Only use the "Windshield defrosting" function briefly until the windshield is clear again. The indicator lamp in the **MAX** button comes on when the function is switched on.
- Only use air-recirculation mode briefly, e.g. if there are unpleasant outside odors or when in a tunnel. The windows could otherwise fog up as no fresh air is drawn into the vehicle in air-recirculation mode. The indicator lamp in the **RECIRC** button comes on when the function is switched on.

- If you wish to use the driver's side settings on the front-passenger side and, for vehicles with rear-compartment air conditioning, for the rear compartment as well, use the "Synchronization" function. The indicator lamp in the **SYNC** button comes on when the function is switched on.
- After long journeys, you can use the residual heat of the engine to heat the stationary vehicle. The residual heat utilization can only be switched on or off while the ignition is switched off. The indicator lamp in the **REST** button comes on when the function is switched on.

Approximately 60 minutes after parking the vehicle, dual-zone automatic climate control can switch on automatically, depending on the outside temperature. The vehicle is then ventilated for about 30 minutes at low fan setting and dual-zone automatic climate control is dried out. During automatic engine switch-off, the climate control system only operates at a reduced capacity. Further information on the automatic engine switch-off can be found under "ECO start/stop function" (> page 123).

Optimum use of rear-compartment air conditioning

Vehicles with air-conditioning system

Switch the rear-compartment air-conditioning system on and off using the air-conditioning system control panel. When you switch on the rear-compartment air conditioning, your settings for temperature, airflow and air distribution are automatically adopted on the control panel for the rear-compartment air conditioning.

The indicator lamp in the **REAR** button comes on when the rear-compartment air-conditioning is switched on (> page 109).

Vehicles with dual-zone automatic climate control

To operate the rear-compartment air conditioning, use the control panel of the dual-zone automatic climate control system. When you switch on the rear-compartment air conditioning, you can set the temperature and airflow separately on the control panel. The airflow setting is automatically adopted for the rear-compartment air conditioning. When dual-zone automatic climate control is in **AUTO** automatic mode, the air distribution of the rear-compartment air conditioning is also automatically adjusted.

When you set the temperature and airflow of the rear-compartment air conditioning, the indicator lamp of the **REAR** button (> page 110) flashes. When the rear-compartment air conditioning is switched on, the indicator lamp on the **REAR** button lights up.

For optimum climate control, set the temperature to 72 °F (22 °C) and switch on **AUTO** automatic mode. Only change the temperature in small increments.

Operating the climate control system

Switching the climate control on/off

Important safety notes

When the climate control is switched off, air intake and air circulation also stop. Only use this setting for a brief period. Otherwise, the windows could fog up.

Air-conditioning system

- ▶ Turn the key to position **2** in the ignition lock.
- ▶ **To switch on:** turn airflow control **5** clockwise to at least level **1** - (> page 109).
- ▶ **To switch off:** turn airflow control **5** counter-clockwise to position **0**.

Dual-zone automatic climate control

- ▶ Turn the key to position **2** in the ignition lock.
- ▶ **To switch on:** press the **AUTO** button. The indicator lamp in the **AUTO** button and the display are switched on. The climate control is automatically adjusted depending on the set temperature (> page 113).



or

- ▶ Press the **fan** button and set blower setting 1 or above. The blower settings are shown in the display as a bar graph.
- ▶ **To switch off:** press the **fan** button and, after reaching the lowest blower speed, press it again. The control panel display goes off.









Preferably switch on climate control using the **AUTO** button.

Rear-compartment air-conditioning system



Vehicles with air-conditioning system

- ▶ Switch on air-conditioning system.
- ▶ **To activate/deactivate:** press the  button on the air-conditioning system control panel.
The indicator lamp in the  button comes on when the rear compartment air conditioning is switched on. The settings for temperature, airflow and, in the case of rear-compartment air conditioning, air distribution are adopted for the rear-compartment air conditioning.

Vehicles with dual-zone automatic climate control

- ▶ Switch on dual-zone automatic climate control.
- ▶ **To switch on:** press the  button on the control panel.
The indicator lamp in the  button flashes. The control panel display shows the second menu level for the temperature and airflow setting of the rear compartment air conditioning.
- ▶ Press the  button and set blower setting 1 or above for the rear-compartment air conditioning.
The blower settings are shown in the display as a bar graph. The rear-compartment air conditioning is switched on.
- ▶ If necessary set the temperature for the rear-compartment air conditioning using temperature control  or  (▶ page 110).
The display shows the selected rear-compartment temperature.
If you do not make any more settings for approximately ten seconds, the control panel display shows menu level 1 again for the automatic climate control settings. The indicator lamp in the  button remains lit.
- i** The air distribution setting applies both to automatic climate control and to the rear-compartment air conditioning and cannot be set separately for the two.
- ▶ **To switch off:** press the  button on the control panel.
The indicator lamp in the  button flashes. The control panel display shows the second menu level for the temperature and airflow

setting of the rear compartment air conditioning.

- ▶ Press the  button and, after reaching the lowest blower speed, press it again.
The control panel display goes off and the rear-compartment air conditioning is switched off.
If you do not make any more settings for approximately ten seconds, the control panel display shows menu level 1 again for the automatic climate control settings. The indicator lamp in the  button goes out.

Switching the cooling with air dehumidification function on/off

Important safety notes



The cooling with air dehumidification function of the air conditioning or automatic climate control is only available when the engine is running. The air inside the vehicle is cooled and dehumidified according to the temperature selected.

Condensation may appear on the underside of the vehicle when in cooling mode. This is normal and not a sign that there is a malfunction.

If you switch off the "Cooling with air dehumidification" function, the air inside the vehicle will not be cooled (in warm weather) or dehumidified. Therefore, only switch off the "Cooling with air dehumidification" function briefly. Otherwise, the windows will fog up more quickly.

Switching on and off

For dual-zone automatic climate control, the function for automatic climate control settings can only be activated or deactivated on the first menu level. If you do not set a new value for the rear-compartment climate control in the second menu level within approx. ten seconds, the control panel display goes back to the first menu level.

- ▶ Press the  button.
The indicator lamp in the  switch comes on when the function is switched on.
- i** The cooling with air dehumidification function has a delayed switch-off feature.

Regulating climate control automatically

General notes

When dual-zone automatic climate control is in automatic mode, the set temperature is automatically kept constant. The system automatically regulates the temperature of the dispensed air, the airflow and the air distribution. Automatic mode will achieve optimal operation if the cooling with air dehumidification function is also activated. If desired, the cooling with air dehumidification function can be deactivated (▷ page 112).

Dual-zone automatic climate control

Automatic mode for automatic climate control settings can only be activated or deactivated on the first menu level. If you do not set a new value for the rear-compartment climate control in the second menu level within approx. ten seconds, the control panel display goes back to the first menu level.

- ▶ Switch on climate control (▷ page 111).
- ▶ Set temperature for the driver's and front-passenger side and, for vehicles with rear-compartment air conditioning, for the rear compartment, too (▷ page 113).
- ▶ **To switch automatic mode on or off:** press the **AUTO** button.
If the indicator lamp in the **AUTO** button lights up, automatic mode is activated. The airflow and air distribution are controlled automatically and the windshield defrosting function is deactivated.

If you deactivate automatic mode, the automatic climate control system saves the current settings.

In automatic mode, if you adjust the airflow or air distribution manually, the indicator lamp above the **AUTO** button goes out. The function which has not been changed manually, however, continues to be controlled automatically.

Setting the temperature

Air-conditioning system

- ▶ Switch on climate control (▷ page 111).
- ▶ **To increase or reduce:** turn temperature control ① clockwise or counter-clockwise. When doing so, only change the temperature in small increments, and start in the center position or at 72 °F (22 °C) (▷ page 109).

Dual-zone automatic climate control

You can set the temperature separately for the driver's and front-passenger side. In vehicles with rear-compartment air conditioning, the temperature for the rear can be set additionally. Each set temperature is automatically maintained at a constant level.

- ▶ Switch on climate control (▷ page 111).
- ▶ **To increase or reduce:** turn temperature control ① or ② clockwise or counter-clockwise (▷ page 110). When doing so, only change the temperature in small increments starting at 72 °F (22 °C).
The control panel display shows the set temperature for the left and right side at the respective edge of the display.

Rear-compartment air-conditioning system

Vehicles with air-conditioning system

- ▶ Switch on climate control (▷ page 111).
The air conditioning settings for temperature, airflow and, for rear-compartment air conditioning, also the setting for air distribution are also applied to the rear-compartment climate control.

Vehicles with dual-zone automatic climate control

- ▶ Switch on climate control (▷ page 111).
- ▶ **To increase or decrease:** press the **REAR** button on the control panel of the automatic climate control.
The indicator lamp in the **REAR** button flashes. The control panel display shows the second menu level for the temperature and airflow

setting of the rear compartment air conditioning.



- ▶ Turn temperature control ① or ② counter-clockwise or clockwise (▷ page 110). When doing so, only change the temperature in small increments starting at 72 °F (22 °C). The control panel display shows the temperature set for the rear compartment.

If you do not make any more settings for approximately ten seconds, the control panel display shows menu level 1 again for the automatic climate control settings. The indicator lamp in the **REAR** button remains lit.

Setting the air distribution



Air-conditioning system

Air distribution settings

-  Directs air through the defroster vents
-  Directs air through the center and side air vents
-  Directs air through the footwell vents





Regardless of the air distribution selected, air is always directed to the side air vents. You can adjust this airflow by opening or closing the side air vents (▷ page 118).

Setting the air distribution

- ▶ Switch on climate control (▷ page 111).
- ▶ Press the ,  and/or  button. If the indicator lamp in a button lights up, the air is directed to the corresponding air vents.
- ▶ Adjust the air vents if necessary (▷ page 118).

Dual-zone automatic climate control

Air distribution settings

-  Directs air through the defroster vents
-  Directs air through the defroster, center and side air vents
-  Directs air through the defroster, center, side and footwell vents
-  Directs air through the defroster and footwell vents
-  Directs air through the center and side air vents

-  Directs air through the center, side and footwell vents

-  Directs air through the footwell vents

Regardless of the air distribution selected, air is always directed to the side air vents. You can adjust this airflow by opening or closing the side air vents (▷ page 118).

Setting the air distribution

- ▶ Switch on climate control (▷ page 111).
- ▶ Press the **MÖDE** or **MODE** button to set the air distribution. The control panel display shows the corresponding air distribution symbol.
- ▶ Adjust the air vents if necessary (▷ page 118).

i If the air distribution is set when dual-zone automatic climate control is in automatic mode, automatic control is deactivated. The indicator lamp on the **AUTO** button then goes out. The airflow continues to be adjusted automatically, however.

Rear-compartment air-conditioning system

When the rear-compartment air conditioning is switched on, the air distribution setting on the control panel also applies to the rear-compartment air conditioning.



This also applies to the automatic mode of dual-zone automatic climate control. The air is then automatically directed to the footwell or the headroom of the rear compartment.

Setting the airflow

Air-conditioning system

- ▶ Switch on climate control (▷ page 111).
- ▶ **To increase or reduce:** turn airflow control ⑤ counter-clockwise or clockwise to the desired level (▷ page 109).

Dual-zone automatic climate control

- ▶ Switch on climate control (▷ page 111).
- ▶ **To increase or reduce:** press the  or  button. The control panel display shows the airflow control setting as a bar display.



- i** If the airflow is set when in automatic mode, automatic control is deactivated. The indicator lamp in the **Auto** button then goes out. The air distribution continues to be adjusted automatically, however.

Rear-compartment air-conditioning system

Vehicles with air-conditioning system

- ▶ Switch on climate control (> page 111).
The air conditioning settings for temperature, airflow and, for rear-compartment air conditioning, also the setting for air distribution are also applied to the rear-compartment climate control.

Vehicles with dual-zone automatic climate control

- ▶ Switch on climate control (> page 111).
- ▶ **To increase or decrease:** press the **REAR** button on the control panel of the automatic climate control.
The indicator lamp in the **REAR** button flashes. The control panel display shows the second menu level for the temperature and airflow setting of the rear compartment air conditioning.
- ▶ Press the  or  button.
The control panel display shows the rear-compartment airflow control setting as a bar display.
If you do not make any more settings for approximately ten seconds, the control panel display shows menu level 1 again for the automatic climate control settings. The indicator lamp in the **REAR** button remains lit.

Activating/deactivating the synchronization function

General notes

Dual-zone automatic climate control can be set centrally using the synchronization function. The temperature setting for the driver's side is then adopted for the front-passenger side and, on vehicles with rear-compartment air conditioning, the rear compartment too.

Dual-zone automatic climate control

- ▶ Switch on climate control (> page 111).
- ▶ Press the **SYNC** button.
If the indicator lamp in the **SYNC** button lights up, the function is switched on. The display then shows the temperature set on the driver's side for the front-passenger side.
The synchronization function switches off if the temperature setting for the front-passenger side or for the rear compartment is altered. The indicator lamp on the **SYNC** button then goes out.







Defrosting the windshield

General notes



You can use the following settings to defrost the windshield or to defrost the inside of the windshield and the front side windows.

Only use the following settings until the windshield is clear.

Air-conditioning system

- ▶ Switch on climate control (> page 111).
- ▶ Turn temperature control  and airflow control  clockwise to the  setting (> page 109).
- ▶ Select the  air distribution setting (> page 114).
Only the indicator lamp in the  button lights up. The indicator lamps on the  and  buttons are off.

Dual-zone automatic climate control

- ▶ Switch on climate control (> page 111).
- ▶ **To activate/deactivate the windshield defrosting function:** press the  button.
The indicator lamp in the  button comes on when the windshield defrosting function is switched on. Temperature, airflow and air distribution are automatically set to the optimum defrosting effect. Air-recirculation mode is deactivated.
When you activate automatic mode, the windshield defrosting function is automatically deactivated.

When you deactivate the windshield defrosting function, the previous automatic climate control



settings are reactivated with the exception of air-recirculation mode. Air-recirculation mode remains deactivated.

Clearing condensation from the windows

Windows fogged up on the inside

Air-conditioning system

You should only select this setting until the windows are clear again.

- ▶ Switch on the rear window defroster if necessary (▷ page 116).
- ▶ Switch on climate control (▷ page 111).
- ▶ Switch off air-recirculation mode (▷ page 116).
- ▶ Turn temperature control ① clockwise to a higher temperature and air flow control ⑤ to a blower speed between **3** and **6** (▷ page 109).
- ▶ If possible, only select the  setting of the air distribution (▷ page 114). Only the indicator lamp in the  button lights up.
- ▶ Switch on the cooling with air dehumidification function (▷ page 112).
- ▶ If the windows still fog up, set the climate control functions as described for defrosting of the windshield (▷ page 115).

Dual-zone automatic climate control

You should only select this setting until the windows are clear again.

- ▶ Switch on the rear window defroster if necessary (▷ page 116).
- ▶ Switch on climate control (▷ page 111).
- ▶ Switch off air-recirculation mode (▷ page 116).
- ▶ Switch on the cooling with air dehumidification function (▷ page 112).
- ▶ Switch on automatic mode (▷ page 113).
- ▶ If the windows continue to fog up, switch on the windshield defrosting function (▷ page 115).

Windows fogged up on the outside



You should only select this setting until the windshield is clear again.

- ▶ Switch on the windshield wipers (▷ page 104).
- ▶ Switch on climate control (▷ page 111).
- ▶ In warm and damp weather, do not allow cold air to flow onto the windows. Close the side air vents if required (▷ page 118).

Switching the rear window defroster on/off

General notes

The rear window defroster consumes a lot of power. You should therefore switch off the rear window defroster as soon as the rear window is clear.

- ▶ Turn the key to position **2** in the ignition lock.
- ▶ Press the  button on the control panel. If the indicator lamp in the  button lights up, the rear window defroster is switched on.

The rear window defroster switches off automatically after a few minutes.

Problems with the rear window defroster

The rear window defroster has switched off prematurely or cannot be activated.

The vehicle starter battery is not sufficiently charged.

- ▶ Switch off any consumers that are not required, e.g. reading lamps, interior lighting or seat heating. When the battery is sufficiently charged, the rear window defroster can be activated again.

Switching air-recirculation mode on/off



Important safety notes

You can deactivate the intake of fresh air if unpleasant odors enter the vehicle from outside. The air inside the vehicle is then circulated.

When you switch on air-recirculation mode, the side windows and windows could fog up more

quickly, in particular at low outside temperatures. Only switch on air-recirculation mode for a short time.

Air-conditioning system or dual-zone automatic climate control

- ▶ Switch on climate control (> page 111).
- ▶ Press the  button.
If the indicator lamp in the  button lights up, air-recirculation mode is activated.

Air-recirculation mode switches on automatically:

- at high outside temperatures.
- while driving in a tunnel (only vehicles with a navigation system).

The indicator lamp in the  button is then not lit up. Outside air is added automatically after about 30 minutes.

Air-recirculation mode is deactivated automatically:

- after approximately five minutes at outside temperatures below about 45 °F (7 °C)
- after approximately five minutes when the cooling with air-dehumidification function is deactivated
- after approximately 30 minutes at outside temperatures above about 45 °F (7 °C) and when the cooling with air-dehumidification function is active

Convenience opening/pre-entry climate control

WARNING

During convenience opening, body parts could be drawn in or become trapped between the side window and the door frame. There is a risk of injury.

Monitor the entire opening procedure when using convenience opening. When opening, make sure that nobody touches the side window. Release the  switch immediately if somebody becomes trapped, to interrupt the opening procedure.

- ▶ **Pre-entry climate control and convenience opening with the key:** press and hold the  button on the key.

The side windows open automatically and the blower of the climate control system is activated.

- ▶ Release the  button.

- i** At high interior temperatures, the blower is also switched on when a door is opened. This means that slightly cooled air enters the vehicle interior after the engine is started, to cool the vehicle more rapidly.



Switching the residual heat function on/off

General notes

Only vehicles with dual-zone automatic climate control have the residual heat function.

Once the engine is switched off, it is possible to make use of the residual heat of the engine to continue heating or ventilating the front compartment of the vehicle for approximately 30 minutes. The heating or ventilation time depends on the set interior temperature.

Switching the function on/off

- ▶ Turn the key to position **0** in the ignition lock or remove it.
- ▶ Press the  button.
If the residual heat function is activated, the indicator lamp in the  button comes on. The blower will run at a low speed regardless of the airflow setting.

If you activate the residual heat function at high temperatures, only the auxiliary ventilation will be activated. The blower then runs at medium speed.

The residual heat function switches off automatically

- after approximately 30 minutes
- if the starter battery's condition of charge is too low
- when you switch on the ignition

Adjusting the air vents

Important safety notes

WARNING

Very hot or very cold air can flow from the air vents. This could result in burns or frostbite in the immediate vicinity of the air vents. There is a risk of injury.

Make sure that all vehicle occupants always maintain a sufficient distance to the air outlets. If necessary, redirect the airflow to another area of the vehicle interior.

The center and side air vents are adjustable. The air vents can also be adjusted on vehicles with rear-compartment air conditioning. In order to ensure the direct flow of fresh air through the air vents into the vehicle interior, please observe the following notes:

- keep the air inlet between the windshield and the hood free of blockages, such as ice, snow or leaves.
- never cover the vents or the ventilation grilles in the vehicle interior.

Setting the center air vents

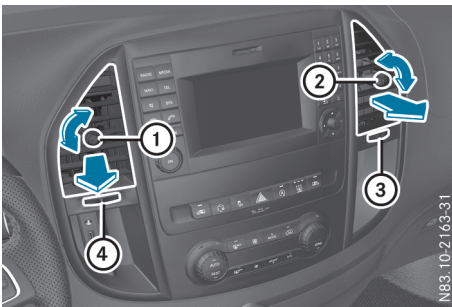

- ① Control for center air vent, left
- ② Control for center air vent, right
- ③ Thumbwheel for center air vent, right
- ④ Thumbwheel for center air vent, left

- ▶ **To open/close:** turn control ① or ② clockwise or counter-clockwise as far as it will go.
- ▶ **To adjust the air direction:** hold side air vent by control ① or ② and move it up or down.
- ▶ Using thumbwheel ③ or ④ move center air vent to the left or right.

Setting the side air vents

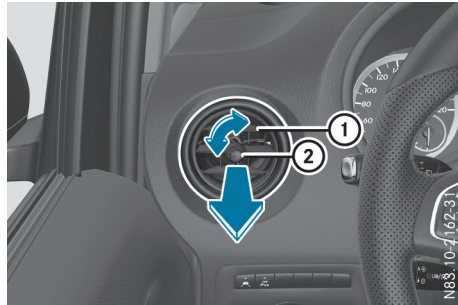

- ① Side air vent
- ② Control for side air vent

- ▶ **To open/close:** turn control ② to the left or right as far as it will go.
- ▶ **To adjust the air direction:** hold side air vent ① by control ② and move it up or down or to the left or right.

Setting the rear-compartment air vents

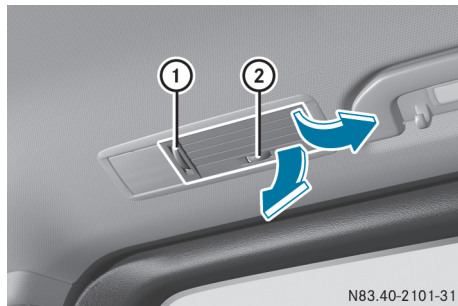

- Rear air vents (example: right-hand side of vehicle)
- ① Thumbwheel for vertical adjustment of the airflow and air quantity control
 - ② Thumbwheel for horizontal adjustment of the airflow

The air vents can only be adjusted on vehicles with rear-compartment air conditioning.

Vehicles with rear-compartment air conditioning: in heating mode, the air in the rear compartment is automatically distributed in the footwells and roof area after the coolant has reached the required temperature. In cooling mode, in the initial phase the air is distributed in the footwells and roof area of the hot vehicle, and subsequently only in the roof area.

- ▶ **To open:** turn thumbwheel ① of the rear air vent to the center position.
- ▶ **To close:** turn thumbwheel ① to the upper or lower end position.

Useful information

This Operator's Manual describes all models as well as standard and optional equipment of your vehicle that were available at the time of going to print. Country-specific variations are possible. Note that your vehicle may not be equipped with all of the described functions. This also applies to systems and functions relevant to safety.

Read the information on qualified specialist workshops (▷ page 31).

Breaking-in notes

Important safety notes

In certain driving and driving safety systems, the sensors adjust automatically while a certain distance is being driven after the vehicle has been delivered or after repairs. Full system effectiveness is not reached until the end of this teach-in procedure.

New or replaced brake pads and brake discs only reach their optimal braking effect after a few hundred kilometers of driving. Until then, compensate for this by applying greater force to the brake pedal.

The first 1000 miles (1500 km)

For the service life and economy of your vehicle it is crucial that you break in the engine with due care.

- Therefore, protect the engine for the first 1000 miles (1500 km) by driving at varying vehicle and engine speeds.
- Avoid overstraining the vehicle and high engine speeds during this period, e.g. driving at full throttle. Do not exceed $\frac{3}{4}$ of the permissible maximum speed for each gear.
- Do not change down a gear manually in order to brake.
- Try to avoid depressing the accelerator pedal beyond the pressure point (kickdown).

After 1000 miles (1500 km), you can increase the engine speed gradually and accelerate the vehicle to full speed.

- i** You should also observe these notes on breaking-in if the engine or parts of the drive train on your vehicle have been replaced.

Driving

Important safety notes

WARNING

Flammable materials introduced through environmental influence or by animals can ignite if in contact with the exhaust system or parts of the engine that heat up. There is a risk of fire.

Carry out regular checks to make sure that there are no flammable foreign materials in the engine compartment or in the exhaust system.

WARNING

If you switch off the ignition while driving, safety-relevant functions are only available with limitations, or not at all. This could affect, for example, the power steering and the brake boosting effect. You will require considerably more effort to steer and brake. There is a risk of an accident.

Do not switch off the ignition while driving.

WARNING

If the parking brake has not been fully released when driving, the parking brake can:

- overheat and cause a fire
- lose its hold function.

There is a risk of fire and an accident. Release the parking brake fully before driving off.

- !** Warm up the engine quickly. Do not use the engine's full performance until it has reached operating temperature.

Only shift the automatic transmission to the desired drive position when the vehicle is stationary.

Where possible, avoid spinning the drive wheels when pulling away on slippery roads. You could otherwise damage the drive train.

Key positions

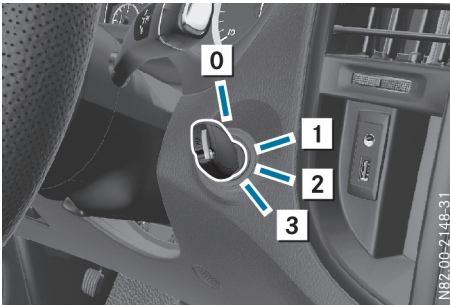

- 0 To insert/remove the key, to lock the steering wheel
 - 1 To unlock the steering wheel, power supply for some consumers (e.g. the radio)
 - 2 To switch on the ignition, power supply for all consumers, preglow and drive position
 - 3 To start the engine
- i** If the key does not belong to the vehicle, it can still be turned in the ignition lock. However, the ignition will not be switched on. The engine cannot be started.

Preparing for a journey

Visual check of the vehicle exterior

- ▶ In particular, check the following components on the vehicle, and on the trailer as necessary:
 - license plates, vehicle lighting, turn signals, brake lamps and wiper blades for dirt and damage
 - tires and wheels for firm seating, correct tire pressure and general condition
 - trailer tow hitch for play and security

The trailer coupling is one of the most important vehicle parts with regard to road safety. Observe the notes on operation, care and maintenance of the trailer tow hitch (see the manufacturer's operating instructions).
- ▶ Rectify any noticeable defects before commencing the journey.

Checks in the vehicle

Emergency equipment/first-aid kit

- ▶ Check the equipment to make sure that it is accessible, complete and ready for use.

The first aid and breakdown assistance equipment is located:

- in the front door stowage compartments
- in the seat base of the left front seat
- in the rear stowage compartment on the right-hand side of the vehicle (▷ page 270)

Vehicle lighting

- ▶ Turn the key to position **2** in the ignition lock.
- ▶ Check the lighting system with the aid of a second person.
- ▶ Replace defective bulbs (▷ page 100).

Before driving off

⚠ WARNING

Objects in the driver's footwell may restrict the clearance around the pedals or block a depressed pedal. This jeopardizes the operating and road safety of the vehicle. There is a risk of an accident.

Stow all objects securely in the vehicle so that they do not get into the driver's footwell. When using floor mats or carpets, make sure that they are properly secured so that they do not slip or obstruct the pedals. Do not place several floor mats or carpets on top of one another.

⚠ WARNING

Unsuitable footwear can hinder correct usage of the pedals, e.g.:

- shoes with thick soles
- shoes with high heels
- slippers

There is a risk of an accident.

Wear suitable footwear to ensure correct usage of the pedals.

- ▶ Stow luggage items securely. Secure the load as per the loading guidelines (▷ page 242).
- ▶ Make sure that the floor mats and carpets are properly secured so that they cannot slip and obstruct the pedals.
- ▶ Close all doors.

Starting the engine

Important safety notes

WARNING

Combustion engines emit poisonous exhaust gases such as carbon monoxide. Inhaling these exhaust gases leads to poisoning. There is a risk of fatal injury. Therefore never leave the engine running in enclosed spaces without sufficient ventilation.

- ❗ Do not depress the accelerator when starting the engine.
- ▶ Before starting the engine, make sure that:
 - all the doors are closed.
 - all the vehicle occupants are wearing their seat belts correctly.
 - the parking brake is applied.
- i If you depress the brake pedal before starting the engine, the pedal travel may be shorter and pedal resistance higher.
If you depress the brake pedal again after starting the engine, pedal travel and resistance will be back to normal again.

Automatic transmission

- ▶ Shift the transmission to position **P** (▷ page 127).
The transmission position indicator in the display shows **P**.

You can also start the engine in neutral **N**.

Starting the engine

- ▶ Turn the key to position **3** in the ignition lock (▷ page 121) and release it as soon as the engine is running.

Driving off

Automatic transmission

WARNING

If the engine speed is above the idling speed and you engage transmission position **D** or **R**, the vehicle could pull away suddenly. There is a risk of an accident.

When engaging transmission position **D** or **R**, always firmly depress the brake pedal and do not simultaneously accelerate.

- ❗ Only shift into reverse gear **R** when the vehicle is stationary. Otherwise, you could damage the transmission.
- ▶ Depress the brake pedal and keep it depressed.
The parking lock is released.
- ▶ Shift the transmission to position **D** or **R**.
On vehicles with a reverse warning feature, a warning signal sounds when reverse gear **R** is engaged to alert other road users (▷ page 123).
- ▶ Release the parking brake (▷ page 134).
The **PARK** (only USA) or **(P)** (only Canada) indicator lamp in the instrument cluster goes out.
- ▶ Release the brake pedal.
Hill start assist automatically maintains the brake pressure for about another two seconds after the brake pedal is released. This makes it possible to pull away without the vehicle immediately rolling back (▷ page 123).
- ▶ Carefully depress the accelerator pedal.

It is only possible to shift the transmission from position **P** to the desired position if you depress the brake pedal. Only then is the parking lock released. If the brake pedal is not depressed, the DIRECT SELECT lever can still be moved but the parking lock remains engaged.

The vehicle locks centrally once you have pulled away. The locking knobs in the doors drop down. You can open the doors from the inside at any time.

You can also deactivate the automatic locking feature (▷ page 74).

Hill start assist

Hill start assist helps you when pulling away forwards or in reverse on an uphill gradient. Hill start assist automatically maintains the brake pressure for about another second, after you have taken your foot off the brake pedal. This gives you enough time to move your foot from the brake pedal to the accelerator pedal and depress it before the vehicle begins to roll.

WARNING

After a short time, hill start assist will no longer brake your vehicle and it could roll away. There is a risk of an accident and injury.

Therefore, quickly move your foot from the brake pedal to the accelerator pedal. Never leave the vehicle when it is held by hill start assist.

Hill start assist is not active if:

- you are pulling away on a level road or a downhill gradient
- the transmission is in position **N**
- the parking brake is applied
- ESP® is malfunctioning

Reverse warning device

WARNING

Other road users may ignore or fail to hear the warning tone of the reverse warning feature. There is a risk of injury if you fail to ensure that the area in which you are maneuvering is clear.

Make sure that there are no persons or objects in the area in which you are maneuvering. It may be necessary to enlist the help of a second person when maneuvering.

The reverse warning feature is a system designed to assist you in ensuring the safety of other road users.

A warning signal sounds to alert other road users when reverse gear is engaged. The volume of the warning tone can be reduced for nighttime driving.

- ▶ **To reduce the volume of the warning tone:** engage reverse gear twice in quick succession.

The warning tone is now quieter.

- i** The warning tone sounds at a normal volume by default. The volume of the warning tone has to be reduced each time you engage reverse gear if necessary.

ECO start/stop function

General notes

When the ECO start/stop function is operational, it switches the engine off automatically if the vehicle is slowed to a stop under certain conditions.

When pulling away again, it starts the engine automatically. The ECO start/stop function thereby helps you to reduce the fuel consumption and emissions of your vehicle.



The stop/start function is automatically activated each time you start the engine with the key. In drive program **M** the ECO start/stop function is automatically deactivated. You can manually activate the ECO start/stop function if required.

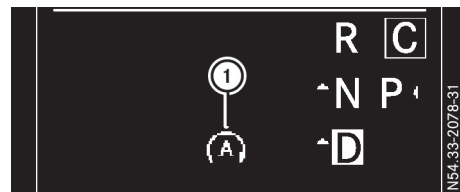

Display (example for vehicles without steering wheel buttons)



Display (example for vehicles with steering wheel buttons)

If the display shows  ECO symbol  in the status area or in the footer, the ECO start/stop function will switch the engine off automatically when the vehicle comes to a stop.

Important safety notes

WARNING

If the engine is switched off automatically and you exit the vehicle, the engine is restarted automatically. The vehicle may begin moving. There is a risk of accident and injury.

If you wish to exit the vehicle, always turn off the ignition and secure the vehicle against rolling away.

Automatic engine switch-off

General notes

The ECO start/stop function is operational when the  ECO symbol is shown in the status bar of the display.

For this to happen, various conditions, including the following, must be met:



- the ECO start/stop function is switched on. The indicator lamp in the  ECO button is lit (▷ page 125).
- the outside temperature is above 32 °F (0 °C).
- the engine has reached its operating temperature.
- the set temperature for the vehicle interior has been reached.
- the condition of charge of the starter battery is sufficient.
- the system detects that the windshield is not fogged up when the air-conditioning system or automatic climate control is switched on.
- the hood is closed.
- the driver's seat belt is fastened.
- the driver's door is closed.
- there is no danger of immediately rolling backwards, e.g. when stopped on a steep gradient.

If a trailer is attached and/or a rear carrier system is installed and connected electrically, this danger is detected on less steep gradients.

Only if all the conditions for automatic engine switch-off are fulfilled, does the display show the  ECO symbol.

All of the vehicle's systems remain active when the engine is switched off automatically.

The engine can be switched off automatically a maximum of four times (initial stop, then three

subsequent stops) in succession. After that, the display hides the  ECO symbol. Automatic engine switch-off is not possible again until the  ECO symbol is shown again.



If you open the hood after an automatic engine switch-off, the automatic engine start is deactivated. Once the hood is closed, you have to start the engine manually.

If the vehicle is stopped in **D** or **N**, the ECO start/stop function switches off the engine automatically once the vehicle is stationary.

Automatic engine start

General notes

The engine is started automatically if:

- you switch off the ECO start/stop function by pressing the  ECO button. The indicator lamp in the  ECO button then goes out. (▷ page 125)
- you depress the accelerator pedal.
- you engage reverse gear **R**.
- you unfasten your seat belt.
- you open the driver's door.
- the vehicle begins to roll away.
- the brake system requires this.
- the temperature in the vehicle interior increasingly deviates from the set value.
- the system detects moisture on the windshield when the air-conditioning system is switched on.
- the battery's condition of charge is too low.



The engine is started automatically if you:

- switch to drive program **M** (▷ page 129)
- release the brake pedal when in transmission position **D** or **N**
- switch to transmission position **P**

After shifting from transmission position **R** to **D**, the ECO start/stop function is not available until the  ECO symbol is shown in the display.

Activating and deactivating the ECO start/stop function



▶ Press the  ECO button.
When the indicator lamp in the  ECO button lights up, the ECO start/stop function is activated.

When all the conditions for automatic engine switch-off are fulfilled, the display shows the  ECO symbol in the status bar (> page 124). The engine is then automatically switched off when the vehicle comes to a stop.

Problems with the engine

Problem	Possible causes/consequences and ▶ Solutions
The engine does not start. The starter motor can be heard.	There is a malfunction in the fuel supply. ▶ Turn the key back to position 0 in the ignition lock before attempting to start the engine again. ▶ Start the engine again. Please bear in mind that lengthy and frequent starting attempts will drain the battery. If the engine does not start after several attempts: ▶ Consult a qualified specialist workshop.
The engine does not start. The starter motor can be heard. The reserve fuel warning lamp is lit and the fuel gage is at 0 .	The fuel tank has been run dry. ▶ Refuel the vehicle.
The engine does not start. The starter motor cannot be heard.	The on-board voltage is too low. The battery is too weak or discharged. ▶ Jump-start the vehicle (> page 272). If the engine cannot be jump-started, the starter motor is faulty. ▶ Consult a qualified specialist workshop.

Problem	Possible causes/consequences and ► Solutions
The engine does not start. The starter motor cannot be heard.	The battery is discharged or faulty. ► Check the battery for damage. ► Charge the battery (▷ page 262).
The engine is not running smoothly and is misfiring.	There is a malfunction in the engine electronics or a mechanical component of the engine management system. ► Only depress the accelerator pedal slightly. Unburnt fuel may otherwise get into the catalytic converter and damage it. ► Have the cause rectified immediately at a qualified specialist workshop.

Automatic transmission

Important safety notes

⚠ WARNING

If the engine speed is above the idling speed and you engage transmission position **D** or **R**, the vehicle could pull away suddenly. There is a risk of an accident.

When engaging transmission position **D** or **R**, always depress the brake pedal and do not simultaneously accelerate.

⚠ WARNING

The automatic transmission switches to neutral position **N** when you switch off the engine. The vehicle may roll away. There is a risk of an accident.

Before switching off the engine, always switch to parking position **P**. Prevent the parked vehicle from rolling away by applying the parking brake.

! If the engine is switched off, rolling in neutral **N** can damage the power transmission and result in transmission damage.

Always observe the instructions and safety notes under "Tow starting and towing away" (▷ page 274).

Bear in mind that power transmission between the engine and the transmission is interrupted when the engine is switched off. For this reason, shift the automatic transmission to **P** before the

engine is switched off and with the vehicle is stationary. Apply the parking brake to prevent the vehicle from rolling away.

DIRECT SELECT lever

Overview of the transmission shift system

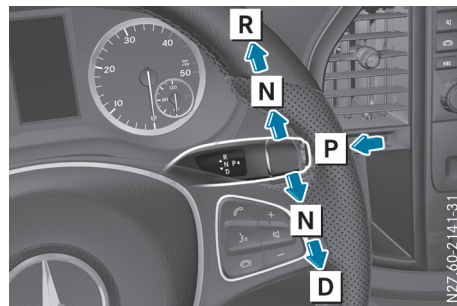

- P** Park position with parking lock
- R** Reverse gear
- N** Neutral
- D** Drive

The DIRECT SELECT lever is on the right of the steering column.

The DIRECT SELECT lever always returns to its original position. The display in the instrument cluster shows the current transmission position, namely **P**, **R**, **N** or **D** (▷ page 128).

Selecting transmission positions

! If the engine speed is too high or the vehicle is moving, do not shift the automatic transmission directly from **D** to **R**, from **R** to **D** or directly to **P**. The automatic transmission could otherwise be damaged.

! Only shift the automatic transmission to **R** when the vehicle is stationary.

▶ If park position **P** is selected, depress the brake pedal to change the transmission position.

▶ **Drive position D:** push the DIRECT SELECT lever down beyond the 1st point of resistance.

▶ **Reverse gear R:** push the DIRECT SELECT lever up beyond the 1st point of resistance.

i The ECO start/stop function is not available when reverse gear is engaged. Further information can be found under "ECO start/stop function" (▷ page 123).

▶ **Neutral N:** push the DIRECT SELECT lever up or down as far as the 1st point of resistance.

i When you switch off the engine, the automatic transmission shifts to **N** automatically.

▶ **Park position P:** press the button of the DIRECT SELECT lever in the direction of arrow **P**.

Park position **P** is engaged automatically if you:

- remove the key
- open the driver's door while the vehicle is stationary or traveling at very low speeds and the transmission is in position **D** or **R**

If you want the automatic transmission to remain in neutral **N** after you switch off the engine, you must leave the key in the ignition lock. This is necessary, for example, when washing the vehicle in a car wash with a conveyor.

Transmission positions

P

Park position

This prevents the vehicle from rolling away when stopped. Do not shift the transmission into position **P** unless the vehicle is stationary.

The automatic transmission shifts to **P** automatically if you:

- remove the key
- open the driver's door while the vehicle is stationary or traveling at very low speeds and the transmission is in position **D** or **R**.

The parking lock should not be used as a brake when parking. Always apply the parking brake as well once you have parked the vehicle.

R

Reverse gear

Only shift the transmission to **R** when the vehicle is stationary.

N

Neutral

No power is transmitted from the engine to the drive wheels. Releasing the brakes will allow you to move the vehicle freely, e.g. by pushing or towing.

If ESP[®] is deactivated or faulty: shift the transmission to position **N** if the vehicle is in danger of skidding, e.g. on icy roads.

When you switch off the engine, the automatic transmission automatically shifts into neutral **N**.

! If the engine is switched off, rolling in neutral **N** can damage the power transmission and result in transmission damage.

D

Drive

The automatic transmission changes gear itself. All forward gears are available.

You can influence gearshifts with your choice of drive program. You can also restrict the shift range.

Transmission position and drive program display

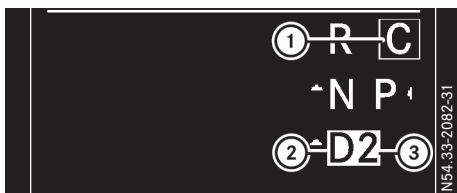

- ① Drive program
- ② Current transmission position or current gear in drive program **M**
- ③ Shift range, if restricted

The transmission positions and current drive program ① are shown at the bottom of the instrument cluster display. The current transmission position is highlighted.

In drive program **M**, the transmission position indicator shows the current gear in position **D** (▷ page 130).

If you restrict the shift range, the transmission position indicator shows the current transmission position plus restricted shift range ③, e.g. **D2** (▷ page 128).

The arrows in the transmission position display show how and into which transmission positions you can change using the DIRECT SELECT lever.

Changing gear

The 7-speed automatic transmission adapts to your individual driving style by continuously adjusting its shift points. These shift point adjustments take into account the current operating and driving conditions. If the operating or driving conditions change, the automatic transmission reacts by adjusting the gearshift program.

The 7-speed automatic transmission shifts to the individual gears automatically when it is in transmission position **D**. This depends on:

- the drive program selected (▷ page 129)
- any restriction in the shift range (▷ page 128)
- the position of the accelerator pedal
- the road speed

You can also change gear manually if you select drive program **M** (▷ page 130).

Shift ranges

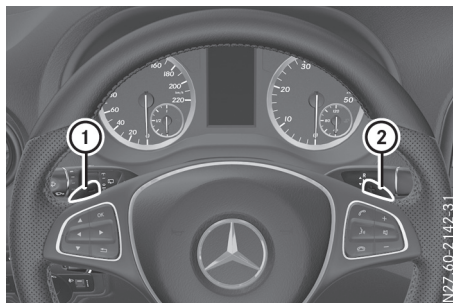

- ① To shift down and restrict the shift range
- ② To shift up and derestrict the shift range

In transmission position **D** and drive programs **E** and **C**, you can use the steering wheel paddle shifters to change gear yourself and restrict or derestrict the shift range of the automatic transmission.

► **To shift down and restrict the shift range:** briefly pull left steering wheel paddle shifter ①.

The automatic transmission shifts to the next gear down, depending on the gear currently engaged. The shift range is also restricted.

The transmission position indicator also shows the set shift range, e.g. **D2**. The automatic transmission shifts only as far as the relevant gear.

or

► Pull and hold left steering wheel paddle shifter ①.

The automatic transmission will shift to a range which allows easy acceleration and deceleration. To do this, the automatic transmission shifts down one or more gears and restricts the shift range.

The transmission position indicator also shows the set shift range, e.g. **D2**. The automatic transmission shifts only as far as the relevant gear.

The automatic transmission does not shift down if you pull the left steering wheel paddle shifter whilst traveling at too high a speed. If the maximum engine speed for the restricted shift range is reached and you continue to depress the accelerator pedal, the automatic transmission will shift up automatically. This protects the engine from overrevving.

- **To shift up and extend the shift range:** briefly pull right steering wheel paddle shifter ②. The automatic transmission shifts to the next gear up, depending on the gear currently engaged. This derestricts the shift range at the same time.

If the display shows only transmission position **D**, the shift range restriction is canceled.

- **To derestrict the shift range:** pull and hold right steering wheel paddle shifter ②. The automatic transmission shifts up one or more gears depending on the gear currently engaged. At the same time, the shift range restriction is canceled and the display shows transmission position **D**.

Shift ranges and driving situations

3	Use the engine's braking effect.
2	Use the braking effect of the engine on steep downhill gradients and for driving: <ul style="list-style-type: none"> • on steep mountain roads • in mountainous terrain • in arduous conditions
1	Use the braking effect of the engine on extremely steep downhill gradients and long downhill stretches.

Drive programs

General notes

You can use the program selector button to choose between different drive programs for the automatic transmission. Engine management and the gearshifting characteristics of the automatic transmission change depending on which drive program is selected. Thus, a more comfort-oriented or a more economical driving style is supported, depending on the wish of the driver. Selecting drive program **M** deactivates automatic gearshifting, requiring that you change gear manually.

After the engine is started, the automatic transmission automatically switches to drive program **C** (Comfort) for a comfortable and economical driving style.

Program selector button

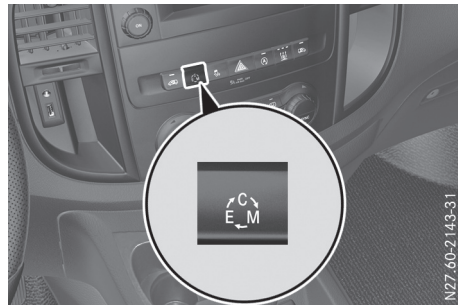

- Press the  program selector button repeatedly until the desired drive program is selected. The display shows the letter of the selected drive program at the top of the transmission position indicator (▷ page 128).

M Manual	Manual gearshifting
C Comfort	Comfortable, economical driving style
E Eco	Particularly economical driving style

Drive program (M)

The **Manual** drive program is characterized by the following:

- The automatic transmission must be shifted manually at all times. the automatic transmission does not shift up automatically even when the maximum engine speed is reached (▷ page 130).
- the ECO start/stop function must be activated manually.

Drive program C

Drive program **Comfort** has the following characteristics:

- the vehicle delivers comfortable, economical handling characteristics.
- optimal fuel consumption resulting from the automatic transmission shifting up sooner.

- increased sensitivity. This improves driving stability on slippery road surfaces, for example.
- the automatic transmission shifts up sooner. The vehicle thus maintains lower engine speeds.

Drive program E

Drive program **Eco** has the following characteristics:

- the vehicle exhibits particularly economical handling characteristics.
- the maximum available engine torque is reduced.
- optimal fuel consumption resulting from the automatic transmission shifting down significantly later and up significantly sooner, even at full-load operation.

No shift point adjustment for adapting to individual, dynamic driving styles.

In kickdown, the automatic transmission automatically shifts to drive program **C**.

- increased sensitivity. This improves driving stability on slippery road surfaces, for example.

Driving tips

Accelerator pedal position

Your style of driving influences how the automatic transmission shifts gear:

- little throttle: early upshifts
- lots of throttle: later upshifts

Kickdown

Use kickdown for maximum acceleration:

- ▶ Depress the accelerator pedal beyond the pressure point.
The automatic transmission shifts to the next gear down, depending on the engine speed.
- ▶ Ease off on the accelerator pedal once the desired speed is reached.
The automatic transmission shifts up again.

Rocking the vehicle free

At speeds up to 5 mph (9 km/h) you can switch back and forth between drive position **D** and reverse gear **R** without applying the brakes. This helps when rocking the vehicle out of snow or slush.

- ▶ Push the DIRECT SELECT lever alternately up and down beyond the first point of resistance.

Towing a trailer

- ▶ Depending on the downhill gradient, limit the shift range (> page 128) or shift manually into a lower gear (> page 130) in which the engine will operate in the middle of the engine speed range. This also applies if cruise control is activated.

Manual gearshifting

General notes

If you select drive program **M**, automatic gearshifting is deactivated and manual gearshifting is automatically activated. You must then permanently change gear yourself for as long as the drive program is selected.

Permanent manual gearshifting is deactivated automatically when you switch from drive program **M** to another drive program. The automatic transmission then shifts gears automatically. The display shows the selected drive program and transmission position **D** again.

Shifting gears

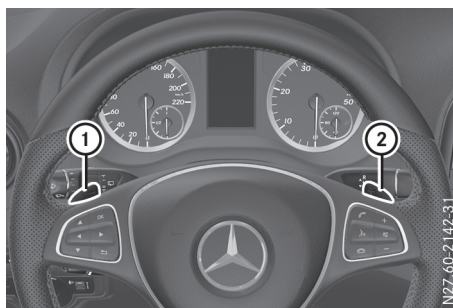

- ① To shift down
- ② To shift up

The drive program display shows **M** and the transmission position indicator shows the selected gear.

- ▶ **To shift up:** briefly pull right-hand steering wheel paddle shifter ②.
If the engine speed is sufficient, the automatic transmission shifts up to the next gear.
If the maximum engine speed is reached in the currently engaged gear and you continue to accelerate, the automatic transmission will not shift up automatically. Always make sure that the engine speed does not reach the red area of the tachometer. Observe the gearshift recommendation in the display (▷ page 131). When the engine reaches its maximum speed, the fuel supply is cut to prevent the engine from overrevving.
- ▶ **To shift down:** pull briefly on left-hand steering wheel paddle shifter ①.
Provided that the engine will not exceed its maximum speed when shifting down, the automatic transmission shifts down to the next gear.

or

- ▶ Pull the left-hand steering wheel paddle shifter until the automatic transmission selects the optimum gear for the current speed.

- ⓘ When coasting, the automatic transmission shifts down automatically.

Gearshift recommendation

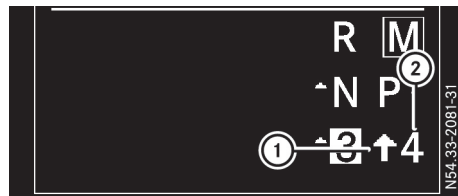

- ① Gearshift direction
- ② Recommended gear

The gearshift recommendations assist you in adopting an economical driving style.

- ▶ When the display shows the gearshift recommendation, shift to recommended gear ②.

Problems with the transmission

Problem	Possible causes/consequences and ► Solutions
The transmission is locked in position P .	The vehicle electronics are malfunctioning. ► Have the vehicle electronics checked immediately at a qualified specialist workshop.
The acceleration characteristics have deteriorated noticeably. The transmission does not shift.	The transmission is in emergency mode. It is only possible to shift into second gear or reverse gear R . ► Stop the vehicle. ► Depress the brake pedal. ► Move the selector lever to position P . ► Switch off the engine. ► Wait at least ten seconds before restarting the engine. ► Depress the brake pedal. ► Move the selector lever to position D or R . In position D , the transmission shifts into second gear; in position R , the transmission shifts into reverse gear. ► Have the transmission checked immediately at a qualified specialist workshop.

Refueling

Important safety notes

WARNING

Fuel is highly flammable. Improper handling of fuel creates a risk of fire and explosion.

Avoid fire, open flames, smoking and creating sparks under all circumstances. Switch off the engine and, if applicable, the auxiliary heating before refueling.

WARNING

Fuel is poisonous and hazardous to health. There is a risk of injury.

You must make sure that fuel does not come into contact with your skin, eyes or clothing and that it is not swallowed. Do not inhale fuel vapors. Keep fuel away from children.

If you or others come into contact with fuel, observe the following:

- Wash away fuel from skin immediately using soap and water.
- If fuel comes into contact with your eyes, immediately rinse them thoroughly with clean water. Seek medical assistance without delay.
- If fuel is swallowed, seek medical assistance without delay. Do not induce vomiting.
- Immediately change out of clothing which has come into contact with fuel.

WARNING

Electrostatic buildup can create sparks and ignite fuel vapors. There is a risk of fire and explosion.

Always touch the vehicle body before opening the fuel filler flap or touching the fuel pump nozzle. Any existing electrostatic buildup is thereby discharged.

Do not get into the vehicle again during the refueling process. Otherwise, electrostatic charge could build up again.

Environmental note

If fuels are handled improperly, they pose a danger to persons and the environment. Do not allow fuels to run into the sewage system, the surface waters, the ground water or into the ground.

! Do not switch on the ignition if you accidentally refuel with the wrong fuel. Otherwise, the fuel will enter the fuel lines. Notify a qualified specialist workshop and have the fuel tank and fuel lines drained completely.

! Overfilling the fuel tank could damage the fuel system.

! Take care not to spill any fuel on painted surfaces. You could otherwise damage the paintwork.

! Use a filter when adding fuel from a fuel can. The fuel lines and/or the fuel injection system could otherwise be blocked by particles from the fuel can.

You will find further information about fuel and fuel grades under "Service products and capacities" (▷ page 305).

- ▶ Remove the key from the ignition lock.
- ▶ Open the front left-hand door first, and then fuel filler flap ①.
- ▶ Close all vehicle doors to prevent fuel vapors from entering the vehicle interior.
- ▶ Turn fuel filler cap ② counter-clockwise, remove it and let it hang from the strap.
- ▶ Completely insert the filler neck of the fuel pump nozzle into tank ④ and refuel.
- ▶ Only fill the tank until the pump nozzle switches off. Fuel may otherwise leak out.
- ▶ Replace tank filler cap ② on tank ④ and turn clockwise.
You will hear a click when the fuel filler cap is closed fully.
- ▶ Open the front left-hand door first, and then close filler flap ①.

Problems with the fuel and fuel tank

If your vehicle is losing fuel, the fuel lines or the fuel tank are defective.

- ▶ Turn the SmartKey immediately to position 0 in the ignition lock and remove it.
- ▶ Do not restart the engine under any circumstances.
- ▶ Consult a qualified specialist workshop.

Refueling procedure

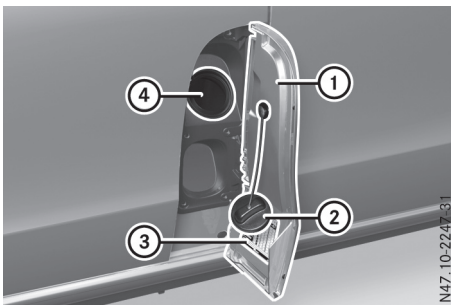

- ① Fuel filler flap
- ② Fuel filler cap
- ③ Tire pressure table (▷ page 280)
- ④ Fuel filler neck

Fuel filler flap ① is on the left side of the vehicle behind the front door. It is only possible to open fuel filler flap ① when the front door is open.

Parking

Important safety notes

⚠ WARNING

Flammable material such as leaves, grass or twigs may ignite if they come into contact with hot parts of the exhaust system or exhaust gas flow. There is a risk of fire.

Park the vehicle so that no flammable materials come into contact with parts of the vehicle which are hot. Take particular care not to park on dry grassland or harvested grain fields.

⚠ WARNING

If you leave children unsupervised in the vehicle, they could set it in motion by, for example:

- release the parking brake.
- shift the automatic transmission out of the parking position **P**.
- start the engine.

In addition, they may operate vehicle equipment and become trapped. There is a risk of an accident and injury.

When leaving the vehicle, always take the SmartKey with you and lock the vehicle. Never leave children unsupervised in the vehicle.

! Always secure the vehicle correctly against rolling away. Otherwise, the vehicle or its drivetrain could be damaged.

! When the vehicle is parked, always remove the key to prevent the battery from becoming discharged.

Always park your vehicle safely and secure it against rolling away. When parking, observe the legal requirements of the country in which you are currently driving.

To ensure that the vehicle is properly secured against rolling away unintentionally:

- the parking brake must be firmly applied
- the transmission must be in position **P** and the key must be removed from the ignition lock
- on steep uphill or downhill gradients, the front wheels must be turned towards the curb

Parking brake**⚠ WARNING**

If you leave children unsupervised in the vehicle, they could set it in motion by, for example:

- release the parking brake.
- shift the automatic transmission out of the parking position **P**.
- start the engine.

In addition, they may operate vehicle equipment and become trapped. There is a risk of an accident and injury.

When leaving the vehicle, always take the SmartKey with you and lock the vehicle. Never leave children unsupervised in the vehicle.

⚠ WARNING

If you must brake the vehicle with the parking brake, the braking distance is considerably longer and the wheels could lock. There is an increased danger of skidding and accidents.

Only use the parking brake to brake the vehicle when the service brake is faulty. Do not apply the parking brake too firmly. If the wheels lock, release the parking brake until the wheels begin turning again.

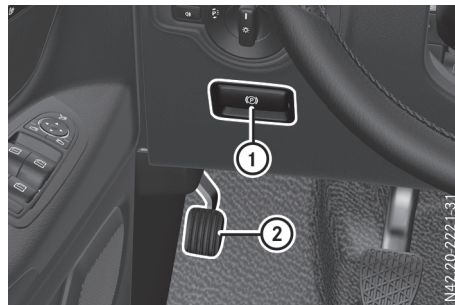

The brake lamps are not illuminated when you brake the vehicle using the parking brake.

As a rule, you may only apply the parking brake when the vehicle is stationary.

- ▶ **To apply the parking brake:** depress parking brake pedal ② firmly.
The red **PARK** (only USA) or **(P)** (only Canada) indicator lamp in the instrument cluster lights up if the engine is running.
- ▶ **To release the parking brake:** depress the brake pedal and keep it depressed.
- ▶ Pull release handle ①.
The parking brake is released abruptly. The red **PARK** (only USA) or **(P)** (only Canada) indicator lamp in the instrument cluster goes out.

Exceptionally, if the service brake fails, the parking brake can be used to brake the vehicle in an emergency.

- ▶ **Emergency braking:** pull release handle ① and gradually depress parking brake pedal ②.

Switching off the engine

Important safety notes

WARNING

The automatic transmission switches to neutral position **N** when you switch off the engine. The vehicle may roll away. There is a risk of an accident.

After switching off the engine, always switch to parking position **P**. Prevent the parked vehicle from rolling away by applying the parking brake.

-  If the coolant temperature is very high, e.g. after driving on hilly roads, leave the engine running at idle speed for about two minutes before turning it off.

This allows the coolant temperature to return to normal.

Vehicles with automatic transmission

- ▶ Stop the vehicle.
- ▶ Shift the transmission to position **P**.
- ▶ Apply the parking brake.
- ▶ Turn the key to position **0** in the ignition lock and remove it.
The immobilizer is activated.
If you switch the engine off with the transmission in position **R** or **D**, the automatic transmission shifts to **N** automatically.
If you then open one of the front doors or remove the key from the ignition, the automatic transmission automatically shifts to **P**.
If you shift the automatic transmission to **N** before switching off the engine, the automatic transmission remains in **N** even if a front door is opened.
- ▶ Secure the vehicle to prevent it from rolling away (▷ page 133).

Parking the vehicle for a long period

If you leave the vehicle parked for longer than four weeks, the battery may be damaged by exhaustive discharging.

- ▶ Disconnect the battery (▷ page 259).
or

- ▶ Connect the battery to a trickle charger. Be sure to observe the notes on charging the batteries (▷ page 262).

You can obtain information about trickle chargers from a qualified specialist workshop.

If you leave the vehicle parked for longer than 6 weeks, the vehicle may suffer damage as a result of lack of use.

- ▶ Visit a qualified specialist workshop and seek advice.

Driving tips

General notes

Important safety notes

WARNING

If you switch off the ignition while driving, safety-relevant functions are only available with limitations, or not at all. This could affect, for example, the power steering and the brake boosting effect. You will require considerably more effort to steer and brake. There is a risk of an accident.

Do not switch off the ignition while driving.

WARNING

If you operate mobile communication equipment while driving, you will be distracted from traffic conditions. You could also lose control of the vehicle. There is a risk of an accident.
Only operate this equipment when the vehicle is stationary.

Observe the legal requirements of the country in which you are driving. Some jurisdictions prohibit the driver from using a mobile phone while driving a vehicle.

Always use the hands-free system for telephoning while driving. Only use the telephone if road traffic conditions permit. If this is not the case, pull over to a safe location before using the telephone.

Bear in mind that at a speed of just 30 mph (approximately 50 km/h), your vehicle is covering a distance of 44 feet (approximately 14 m) every second.

Drive sensibly – save fuel

In order to save fuel, observe the following tips:

- ▶ The tires should always be inflated to the recommended tire pressure.
- ▶ Remove unnecessary loads.
- ▶ Remove roof carriers when they are not needed.
- ▶ Warm up the engine at low engine speeds.
- ▶ Avoid frequent acceleration or braking.
- ▶ Have all maintenance work carried out as indicated by the service intervals in the Maintenance Booklet or by the service interval display.

Fuel consumption also increases when driving in cold weather, in stop-start traffic and in mountainous terrain.

Overrun cutoff

If you are in overrun mode and take your foot off the accelerator pedal, the fuel supply is cut off when the engine speed is out of the idle speed control range.

Drinking and driving

WARNING

Drinking and driving and/or taking drugs and driving are very dangerous combinations. Even a small amount of alcohol or drugs can affect your reflexes, perceptions and judgment.

The possibility of a serious or even fatal accident is greatly increased when you drink or take drugs and drive.

Do not drink or take drugs and drive or allow anyone to drive who has been drinking or taking drugs.

Emission control

WARNING

Combustion engines emit poisonous exhaust gases such as carbon monoxide. Inhaling these exhaust gases leads to poisoning. There is a risk of fatal injury. Therefore never leave the engine running in enclosed spaces without sufficient ventilation.

Certain engine systems are designed to keep the level of poisonous substances in exhaust fumes within legal limits.

These systems only work optimally if they are maintained exactly in accordance with the manufacturer's specifications. Any work on the engine should therefore be carried out by qualified and authorized Mercedes-Benz technicians.

The engine settings must not be changed under any circumstances. In addition, all specific maintenance work must be carried out at regular intervals and in accordance with the service requirements of the dealer listed here on the inside title page. Details can be found in the Maintenance Booklet.

Speed limiter

WARNING

Exceeding the stated tire load-bearing capacity and the approved maximum speed could lead to tire damage or the tire bursting. There is a risk of accident.

Therefore, only use tire types and sizes approved for your vehicle model. Observe the tire load rating and speed rating required for your vehicle.

As the driver, you must be aware of the maximum design speed of the vehicle and the maximum permissible speed based on the tires (tire and tire pressure). In particular, also observe the tire approval regulations for each country.

You must not exceed the speed limit for the tires indicated by the speed rating. The speed rating is stated in the tire tables (▶ page 300).

You can permanently limit the permissible maximum speed of your vehicle, e.g. for driving on winter tires.

Mercedes-Benz recommends that you have the maximum permissible speed programmed at a Mercedes-Benz Commercial Van Center.

Before overtaking, take into consideration that the engine speed limiter prevents the speed increasing beyond the programmed permissible maximum speed.

Driving abroad

Service

An extensive network of authorized Mercedes-Benz Centers is also at your disposal when you are traveling abroad. Nevertheless, please bear in mind that service facilities or replacement parts may not always be immediately available. The relevant workshop directories are available from any Mercedes-Benz Commercial Van Center.

Fuel

In some countries, only fuels with a higher sulfur content are available.

Unsuitable fuel can cause engine damage. You will find information about fuel under "Service products and capacities" (> page 305).

Low-beam headlamps

General notes

When driving in countries in which traffic drives on the opposite side of the road to the country where the vehicle is registered, you must switch the headlamps to symmetrical low beam. This prevents oncoming traffic from being blinded. Symmetrical low beam does not illuminate as large an area of the edge of the road.

Vehicles with halogen headlamps

The headlamps do not need to be switched to symmetrical low beam. The legal requirements of countries in which traffic drives on the opposite side of the road to the country where the vehicle is registered are met without the need to convert the headlamps.

Transport by rail

Transporting your vehicle by rail may be subject to certain restrictions or require special meas-

ures to be taken in some countries due to varying tunnel heights and loading standards.

You can obtain information on this from any Mercedes-Benz Commercial Van Center.

Braking

Important safety notes

WARNING

If you shift down on a slippery road surface in an attempt to increase the engine's braking effect, the drive wheels could lose their grip. There is an increased danger of skidding and accidents.

Do not shift down for additional engine braking on a slippery road surface.

Downhill gradients

 Depressing the brake pedal constantly results in excessive and premature wear to the brake pads.

This also applies to automatic braking if you have activated cruise control.

On long and steep downhill gradients, you should change down to shift range **2** or **1** in good time (> page 128).

This should be observed in particular when driving with a laden vehicle and when towing a trailer.

You thereby make use of the braking effect of the engine and do not have to brake as often to maintain the speed. This relieves the load on the service brake and prevents the brakes from overheating and wearing too quickly.

Heavy and light loads

WARNING

If you rest your foot on the brake pedal while driving, the braking system can overheat. This increases the stopping distance and can even cause the braking system to fail. There is a risk of an accident.

Never use the brake pedal as a footrest. Never depress the brake pedal and the accelerator pedal at the same time.

! Depressing the brake pedal constantly results in excessive and premature wear to the brake pads.

If the brakes have been subjected to a heavy load, do not stop the vehicle immediately. Drive on for a short while. The brakes are cooled down more quickly in the airflow.

Wet road surfaces

If you have been driving for a long time in heavy rain without braking, there may be a delayed response when you first apply the brakes. This may also occur after driving through a car wash or deep water.

You must depress the brake pedal more firmly. Maintain a longer distance to the vehicle in front.

While paying attention to the traffic conditions, you should brake the vehicle firmly after driving on a wet road surface or through a car wash. This heats the brake discs, so that they dry more quickly, which protects them against corrosion.

Limited braking performance on salt-treated roads

When driving on salted roads, salt may start to build up on the brake disks and brake pads. This can increase braking distances considerably. Maintain a greater distance to the vehicle in front.

To remove any build-up of salt that may have formed:

- ▶ Apply the brakes at the start of the journey, occasionally during journey and at the end of the journey. Make sure that you do not endanger other road users when doing so.

Checking the brake pad thickness

In addition to monitoring using the brake pad wear sensor, regularly monitor and check all of the brake pads by performing a visual inspection to look for pad material wear.

If you are unable to check the brake wear on the inside of the wheels, remove the wheels with the tools provided.

Make sure that the brake pad material thickness never falls below 0.12 in (3 mm). Have the brake pads checked and replaced at a qualified specialist workshop, if necessary.

Do not solely rely on the brake pad wear sensor. It is strongly recommended that you have the brake pads checked at a qualified specialist workshop at every service displayed in the maintenance interval indicator, prior to long journeys and whenever the wheels are removed.

New brake discs and brake pads/linings

New brake pads and brake discs only reach their optimal braking effect after about 60 miles (100 kilometers). Until then, compensate for this by applying greater force to the brake pedal. For safety reasons, Mercedes-Benz recommends only installing the following brake discs and brake pads/linings:

- brake discs that have been approved by Mercedes-Benz
- brake pads/linings that have been approved by Mercedes-Benz or are of an equivalent standard of quality

Other brake discs or brake pads/linings can compromise the safety of your vehicle.

Always replace all brake discs or brake pads/linings on an axle at the same time and only have them replaced at a qualified specialist workshop. When replacing the brake discs, always have the brake pads/linings replaced at the same time.

Parking brake

WARNING

If you must brake the vehicle with the parking brake, the braking distance is considerably longer and the wheels could lock. There is an increased danger of skidding and accidents.

Only use the parking brake to brake the vehicle when the service brake is faulty. Do not apply the parking brake too firmly. If the wheels lock, release the parking brake until the wheels begin turning again.

When driving on wet roads or dirt-covered surfaces, road salt and/or dirt may get into the parking brake. This causes corrosion and a reduction of braking force.

In order to prevent this, drive with the parking brake lightly applied from time to time. When doing so, drive for a distance of approximately

110 yds (100 m) at a maximum speed of 12 mph (20 km/h).

The brake lamps are not illuminated when you brake the vehicle using the parking brake.

Driving in wet conditions

Hydroplaning

WARNING

There is a danger of hydroplaning occurring, even if you are driving slowly and your tires have sufficient tread depth, depending on the depth of water on the road. There is a risk of an accident.

For this reason, avoid tire ruts and brake carefully.

Therefore, in heavy rain or other conditions in which hydroplaning can occur, drive as follows:

- reduce your speed
- avoid tire ruts
- apply the brakes with care

Driving on flooded roads

! Do not drive through flooded areas. Check the depth of any water before driving through it. Drive slowly through standing water. Otherwise, water may enter the vehicle interior or the engine compartment. This can damage the electronic components in the engine or the automatic transmission. Water can also be drawn in by the engine's air suction nozzles and this can cause engine damage.

If you have to drive on stretches of road on which water has collected, please bear in mind that:

- the water level of standing water should not be above the lower edge of the front bumper
- do not drive faster than walking speed

Driving in winter

WARNING

If you shift down on a slippery road surface in an attempt to increase the engine's braking effect, the drive wheels could lose their grip.

There is an increased danger of skidding and accidents.

Do not shift down for additional engine braking on a slippery road surface.

! An accumulation of snow and ice, particularly when frozen, caught in the area around the air intake slots, moving parts, the axles and the wheel arches may:

- restrict air intake
- damage vehicle parts
- cause malfunctions by restricting the mobility intended by the design (e.g. reduced possible steering input).

Regularly check the vehicle and remove snow or ice when traveling in wintry conditions.

If there is any damage, inform a qualified specialist workshop.

! Vehicles with automatic transmission may roll only briefly in the neutral position **N**. Prolonged rolling of the wheels, e.g. when being towed, will result in transmission damage.

Have your vehicle winterproofed at a qualified specialist workshop at the onset of winter.

Drive particularly carefully on slippery roads. Avoid sudden acceleration, steering and braking maneuvers. Do not use cruise control.

If the vehicle threatens to skid or cannot be stopped when moving at low speed:

- ▶ Shift the transmission to position **N**.
- ▶ Try to maintain control of the vehicle using corrective steering.

The outside temperature indicator is not designed to serve as an ice-warning device and is therefore unsuitable for that purpose. Changes in the outside temperature are displayed after a short delay.

Indicated temperatures just above the freezing point do not guarantee that the road surface is free of ice. The road may still be icy, especially in wooded areas or on bridges. If you do not adjust your driving style, the vehicle may start to skid. Always adapt your driving style and drive at a speed to suit the prevailing weather conditions.

You should pay special attention to road conditions when temperatures are around freezing point.

You can find further information under:

- "M+S tires" (▷ page 279)
- "Snow chains" (▷ page 280)
- "Driving with summer tires" (▷ page 279)

Also observe the notes under "Winter operation" (▷ page 279).

Driving off-road

Important safety notes

WARNING

If you drive on a steep incline at an angle or turn when driving on an incline, the vehicle could slip sideways, tip and rollover. There is a risk of an accident.

Always drive on a steep incline in the line of fall (straight up or down) and do not turn the vehicle.

WARNING

When driving off-road, your body is subject to forces from all directions, due to the uneven surface. You could be thrown from your seat, for instance. There is a risk of injury.

Always wear a seat belt, even when driving off-road.

WARNING

If you drive over obstacles or in ruts, the steering wheel may jerk out of your grip, causing injury to your hands.

Always hold the steering wheel firmly with both hands. When driving over obstacles, you must expect steering forces to increase briefly and suddenly.

WARNING

Flammable material such as leaves, grass or twigs may ignite if they come into contact with hot parts of the exhaust system. There is a risk of fire.

When driving off road or on unpaved roads, check the vehicle's underside regularly. In particular, remove parts of plants or other flammable materials which have become

trapped. In the case of damage, contact a qualified specialist workshop.

- ❗ When driving off-road or on unpaved surfaces, check the underside of the vehicle and the wheels and tires at regular intervals. In particular, remove any trapped foreign objects, e.g. stones and branches.

Such foreign objects may:

- damage the chassis, the fuel tank or the brake system
- cause imbalances and thus vibrations
- be flung out when you continue driving

If there is any damage, inform a qualified specialist workshop.

When driving off-road and on construction sites, sand, mud and water mixed with oil, for example, may get into the brakes. This may lead to a reduction in braking performance or total brake failure, also as a result of increased wear. The braking characteristics will vary depending on the material that has got into the system. Clean the brakes after driving off-road. If you then notice reduced braking performance or hear scraping noises, have the brake system checked at a qualified specialist workshop. Adjust your driving style to the changed braking characteristics.

Driving off-road or on construction sites increases the possibility of vehicle damage which may in turn lead to the failure of certain assemblies and systems. Adapt your driving style to the off-road driving conditions. Drive carefully. Have any vehicle damage rectified at a qualified specialist workshop as soon as possible.

When loading your vehicle for driving off-road or on a construction site, keep the vehicle's center of gravity as low as possible.

Rules for driving off-road

- ❗ Always bear the vehicle's ground clearance in mind and avoid obstacles, e.g. deep ruts.

Obstacles may damage the following parts of the vehicle:

- the chassis
- the drive train
- the fuel and supply tanks

For this reason, you should always drive slowly when driving off-road. If you have to

drive over obstacles, have the front passenger direct you.

- i** We recommend that you additionally carry a shovel and a recovery rope with shackle in the vehicle.
- Ensure that loads and items of luggage are securely stowed or lashed down (▷ page 242).
- Before driving off-road, stop the vehicle and shift to a low gear.
- If the surface requires, temporarily deactivate ESP® when pulling away (▷ page 66).
- Only drive off-road with the engine running and a gear engaged.
- Drive slowly and smoothly. Walking pace is necessary in many situations.
- Avoid spinning the drive wheels.
- Make sure that the wheels always remain in contact with the ground.
- Drive with extreme care over unknown terrain where you can only see for a short distance. As a precaution, get out of the vehicle to take a look at the route to be taken in advance.
- Check the water depth before fording.
- Watch out for obstacles (e.g. rocks, holes, tree stumps and ruts).
- Avoid edges where the surface could crumble or break away.

Checklist after driving off-road

- !** If you detect damage to the vehicle after driving off-road, have the vehicle checked immediately at a qualified specialist workshop.

Off-road driving places a higher demand on your vehicle than normal road operation. Check your vehicle after driving on rough terrain. By doing so you will notice any damage in good time and reduce the risk of an accident for yourself and other road users. Clean your vehicle thoroughly before driving on public roads.

Observe the following points after driving off-road, on construction sites and before driving on public roads:

- ▶ Activate ESP® (▷ page 66).
- ▶ Clean the headlamps and tail lamps and check them for damage.
- ▶ Clean the front and rear license plates.

- ▶ Clean the windshield, windows and exterior mirrors.
- ▶ Clean the steps, door sills and grab handles. This increases safety of footing.
- ▶ Clean the wheels/tires, wheel housings and the underbody of the vehicle with a water jet. This increases road grip, especially on wet road surfaces.
- ▶ Check the wheels/tires and wheel housings for trapped foreign objects and remove them. Trapped foreign objects can damage the wheels/tires and may be flung out from the vehicle when you continue driving.
- ▶ Check the underbody for trapped branches or other parts of plants and remove them. Trapped branches or other parts of plants increase the risk of fire and can cause damage to fuel lines, brake hoses and the rubber bellows of axle joints and drive shafts.
- ▶ Clean the brake disks, brake pads and axle joints, particularly after operation in sand, mud, grit/gravel, water or similarly dirty conditions.
- ▶ Check the entire floor assembly, the tires, wheels, bodywork structure, brakes, steering, chassis and exhaust system for any damage.
- ▶ Check the service brake for operating safety, e.g. carry out a brake test.
- ▶ If you notice strong vibrations after driving off-road, check the wheels and drive train for foreign objects again. Remove any foreign objects which can lead to imbalances and thus cause vibrations.

Driving in mountainous areas

When driving in mountainous areas, note that the power output of the engine, and with it its gradient climbing capability, decrease with increasing altitude. Please take note of this particularly when driving with a trailer in mountainous areas.

The maximum permissible trailer loads are valid for journeys at altitudes up to 1100 yds (1000 m) above sea level with gradients up to 12%.

Information on maximum permissible trailer loads can be found in your vehicle registration papers and on the vehicle identification plate (▷ page 303) or under "Trailer loads" (▷ page 314).

When driving at altitudes of 2700 yds (2500 m) above sea level, the ECO start/stop function is no longer available.

Notes on braking on downhill gradients can be found in the "Braking" section (> page 137).

Driving systems

Cruise control

General notes

Cruise control maintains the speed of the vehicle for you. It brakes automatically in order to avoid exceeding the set speed.

Use cruise control if road and traffic conditions make it appropriate to maintain a steady speed for a prolonged period. You can set any speed from 30 km/h upwards in increments of 1 km/h and 10 km/h.

If you have set **Miles** as the unit for the digital speedometer, you can set any speed above 20 mph in increments of 1 mph and 5 mph.

Changing the display unit for the digital speedometer and the distance:

- on vehicles without steering wheel buttons (> page 175)
- on vehicles with steering wheel buttons (> page 186)

Cruise control should not be activated when driving off-road or on construction sites.

Cruise control may be unable to maintain the stored speed on uphill gradients. The stored speed is resumed if the uphill gradient evens out and the vehicle's speed does not fall below 20 mph (30 km/h). Cruise control maintains the stored speed on downhill gradients by automatically applying the brakes. Observe the additional driving tips (> page 137).

Important safety notes

Observe the notes on braking (> page 137).

If you fail to adapt your driving style or if you are inattentive, cruise control can neither reduce the risk of an accident nor override the laws of physics. Cruise control cannot take road, weather and traffic conditions into account. Cruise control is only an aid. You are responsible for the distance to the vehicle in front, for vehicle speed, for braking in good time and for staying in lane.

If you change wheel size, make sure they correspond to the correct wheel size category (> page 277). If the category is changed without recoding the control units in the vehicle, the functioning of cruise control may be impaired.

Do not use cruise control:

- in traffic conditions that are unsuitable for driving at a constant speed, e.g. in heavy traffic, on winding roads or off-road.
- on slippery roads. Braking or accelerating may cause the drive wheels to lose traction and the vehicle could then skid.
- when there is poor visibility, e.g. due to fog, heavy rain or snow.

If there is a change of drivers, make sure that you inform the new driver about the set cruise speed.

Cruise control lever and display

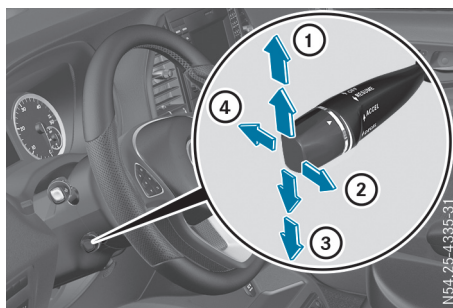

- ① To activate and store the current speed or a higher speed
- ② To activate at the last stored speed
- ③ To activate and store the current speed or a lower speed
- ④ To deactivate cruise control

The cruise control lever is the lower lever on the left of the steering column.

When you activate cruise control, the display briefly shows the **Cruise Control** message and the stored speed.

The display also shows the  symbol and the stored speed:

- in the header on vehicles without steering wheel buttons (> page 171)
- in the status area on vehicles with steering wheel buttons (> page 177)

Activation conditions

To activate cruise control, all of the following activation conditions must be fulfilled:

- the parking brake must be released. The **PARK** (only USA) or **(D)** (only Canada) indicator lamp in the instrument cluster goes out
- ESP[®] must be switched on, but not currently intervening or performing a control action
- you are driving faster than 20 mph (30 km/h)
- the brake pedal is not depressed

Storing and maintaining the current speed

- ▶ Accelerate the vehicle to the desired speed above 20 mph (30 km/h).
- ▶ Briefly push the cruise control lever up ① or down ③.
- ▶ Release the accelerator pedal. Cruise control is activated. The current speed is stored and shown briefly in the display's text field.

The display also shows the  symbol and the stored speed:

- in the header on vehicles without steering wheel buttons (▷ page 171)
- in the status area on vehicles with steering wheel buttons (▷ page 177)

Resuming the stored speed

WARNING

If you call up the stored speed and it differs from the current speed, the vehicle accelerates or decelerates. If you do not know the stored speed, the vehicle could accelerate or brake unexpectedly. There is a risk of an accident.

Pay attention to the road and traffic conditions before calling up the stored speed. If you do not know the stored speed, store the desired speed again.

- ▶ Briefly pull the cruise control lever towards you ②.
- ▶ Release the accelerator pedal. Cruise control is activated and resumes the vehicle's speed to the last speed stored.

The stored speed is shown briefly in the display.

The display also shows the  symbol and the stored speed:

- in the header on vehicles without steering wheel buttons (▷ page 171)
- in the status area on vehicles with steering wheel buttons (▷ page 177)

- i** When you pull the cruise control lever towards you for the first time after starting the engine, cruise control adopts the current speed.

Setting the speed

It may be a moment before the vehicle starts to accelerate or brake to the set speed. Take this delay into account when setting the speed.

- ▶ Press the cruise control lever up ① to increase the speed or down ③ to reduce the speed.

The vehicle will accelerate or decelerate. The speed is shown in the display.

- ▶ Release the cruise control lever once the desired speed is reached.

The displayed speed is stored.

or

- ▶ Briefly press the cruise control lever as far as the 1st pressure point up ① or down ③. The last speed stored is increased/reduced in increments of 1 mph (1 km/h).

or

- ▶ Briefly press the cruise control lever beyond the pressure point up ① or down ③. The last speed stored is increased/reduced in increments of 5 mph (10 km/h).

- i** Cruise control is not deactivated if you depress the accelerator pedal. If you accelerate briefly to overtake, for example, cruise control resumes the vehicle's speed to the last speed stored after you have finished overtaking.

Deactivating cruise control

There are various ways to deactivate cruise control:



- ▶ Briefly press the cruise control lever forwards ④.

or

- ▶ Apply the brakes.

The last speed set remains stored. The last speed stored is deleted when you switch off the engine.

Cruise control is deactivated automatically when:

- you apply the brakes
- you apply the parking brake and the  (only USA) or  (only Canada) indicator lamp in the instrument cluster lights up
- you are driving slower than 20 mph (30 km/h)
- you shift the automatic transmission to neutral position **N** while the vehicle is in motion
- ESP® intervenes or you deactivate ESP®
- there is a malfunction in the ESP® or ABS system

If cruise control automatically deactivates, a warning tone sounds and the **Cruise Control Off** message appears briefly in the display.

The  symbol and the display of the stored speed in the header or in the status area of the display are then not shown.

Problems with cruise control

The speed cannot be set when cruise control is activated.

The display is showing a message of high priority and cannot therefore show a change in speed.

- ▶ Proceed as instructed by the message in the display.

COLLISION PREVENTION ASSIST

General notes

COLLISION PREVENTION ASSIST helps you:

- to minimize the risk of a front-end collision with a detected obstacle in the path of your vehicle
- to reduce the consequences of a front-end collision

The system uses radar sensors to detect vehicles in front.

COLLISION PREVENTION ASSIST consists of the distance warning function and Adaptive Brake Assist.

If COLLISION PREVENTION ASSIST is malfunctioning, the display shows a corresponding message (▷ page 214).

Distance warning function

Important safety notes

WARNING

The distance warning function does not react:

- to people or animals
- to oncoming vehicles
- to crossing traffic
- when cornering

Thus, the distance warning function cannot provide a warning in all critical situations. There is a risk of an accident.

Always pay careful attention to the traffic situation and be ready to brake.

WARNING

The distance warning function cannot always clearly identify objects and complex traffic situations.

In such cases, the distance warning function may:

- give an unnecessary warning
- not give a warning

There is a risk of an accident.

Always pay careful attention to the traffic situation and do not rely solely on the distance warning function.

In particular, the detection of obstacles can be impaired in the case of:

- dirt on the sensors or anything else covering the sensors
- snow or heavy rain
- interference from other radar sources
- strong radar reflections, for example, in parking garages
- a narrow vehicle traveling in front, e.g. a motorbike
- a vehicle traveling in front on a different line

Due to the nature of the system, particularly complicated but non-critical driving conditions may also cause the system to display a warning.

If you fail to adapt your driving style, the distance warning function can neither reduce the risk of an accident nor override the laws of physics. The distance warning function cannot take

into account road, weather or traffic conditions. The distance warning function is only an aid. You are responsible for the distance to the vehicle in front, for vehicle speed, braking in good time and for staying in your lane.

Following damage to the front end of the vehicle, have the configuration and operation of the radar sensor checked at a qualified specialist workshop. This also applies to collisions at slow speeds where there is no visible damage to the front of the vehicle.



If you change wheel size, make sure they correspond to the correct wheel size category (▷ page 277). If the category is changed without recoding the control units in the vehicle, the functioning of the distance warning feature may be impaired. COLLISION PREVENTION ASSIST may then detect a malfunction and switch itself off.

Operation

▶ **To activate/deactivate:** activate or deactivate the distance warning function in the on-board computer (▷ page 185).

If the distance warning function of COLLISION PREVENTION ASSIST is activated, the display shows the  symbol:

- in the header
- in the [Status Overview](#) of the [Assist](#). menu (▷ page 184)

At speeds up to approx 20 mph (30 km/h) the display in vehicles with Active Parking Assist first shows the  status indicator. Only up to a speed of about 20 mph (30 km/h) does the display show the  symbol instead of the  status indicator.

The distance warning function can help you to minimize the risk of a front-end collision with a vehicle ahead or reduce the effects of such a collision. With the help of the radar sensor system, the distance warning function can detect obstacles that are in the path of your vehicle for an extended period of time. If the distance warning function detects that there is a risk of a collision, you will be warned visually and, where necessary, acoustically. Without your intervention, the distance warning function cannot prevent a collision.

The distance warning function issues a warning at speeds:

- from about 4 mph (7 km/h) if you approach a vehicle traveling in front or a stationary vehicle too quickly. The  warning lamp in the

instrument cluster then lights up and an intermittent warning tone also sounds.

At speeds up to about 45 mph (70 km/h), the system also detects stationary obstacles, for example stopped or parked vehicles.

▶ Brake immediately until the distance from the obstacle increases and the risk of a front-end collision passes.

or

▶ Take evasive action, provided it is safe to do so.

Adaptive Brake Assist

General notes

Adaptive Brake Assist evaluates the traffic situation with the help of the radar sensor system and can detect obstacles which have been in your vehicle's path for an extended period of time. From speeds above 4 mph (7 km/h), Adaptive Brake Assist aids you in braking during hazardous situations.

Up to a speed of approximately 125 mph (200 km/h), Adaptive Brake Assist is capable of reacting to moving obstacles that have already been detected as such at least once over the period of observation.

Important safety notes

WARNING

Adaptive Brake Assist does not react:

- to people or animals
- to oncoming vehicles
- to crossing traffic
- to stationary obstacles
- when cornering

As a result, the Adaptive Brake Assist may not intervene in all critical conditions. There is a risk of an accident.

Always pay careful attention to the traffic situation and be ready to brake.

WARNING

Adaptive Brake Assist cannot always clearly identify objects and complex traffic situations.

In such cases, Adaptive Brake Assist can:

- intervene unnecessarily
- not intervene

There is a risk of an accident.

Always pay careful attention to the traffic situation and be ready to brake. Terminate the intervention in a non-critical driving situation.

In particular, the detection of obstacles can be impaired in the case of:

- dirt on the sensors or anything else covering the sensors
- snow or heavy rain
- interference from other radar sources
- strong radar reflections, for example, in parking garages
- a narrow vehicle traveling in front, e.g. a motorbike
- a vehicle traveling in front on a different line

Due to the nature of the system, particularly complicated but non-critical driving conditions may also cause Adaptive Brake Assist to intervene.

If you fail to adapt your driving style, Adaptive Brake Assist can neither reduce the risk of accident nor override the laws of physics. Adaptive Brake Assist cannot take into account road, weather or traffic conditions. Adaptive Brake Assist is only an aid. You are responsible for the distance to the vehicle in front, for vehicle speed, braking in good time and for staying in your lane.

Following damage to the front end of the vehicle, have the configuration and operation of the radar sensor checked at a qualified specialist workshop. This also applies to collisions at slow speeds where there is no visible damage to the front of the vehicle.

If you change wheel size, make sure they correspond to the correct wheel size category (▷ page 277). If the category is changed without recoding the control units in the vehicle, the functioning of Adaptive Brake Assist may be impaired. COLLISION PREVENTION ASSIST may then detect a malfunction and switch itself off.

If Adaptive Brake Assist is not available due to a malfunction in the radar sensor system, the brake system remains available with full brake boosting effect and BAS.

Operation

With the help of the radar sensor system, Adaptive Brake Assist can detect obstacles that have been in the path of your vehicle for an extended period of time. Adaptive Brake Assist does not react to stationary obstacles. If Adaptive Brake Assist detects a risk of collision with a vehicle traveling in front or with a stationary obstacle, the system calculates the braking force necessary to avoid this collision. If you apply the brakes forcefully, Adaptive Brake Assist will automatically increase the braking force to a level suitable for the traffic conditions.

- ▶ Brake until the distance to the obstacle increases and the risk of a collision passes. ABS prevents the wheels from locking.

The brakes function as usual again if:

- you release the brake pedal
- there is no longer any danger of a collision
- no obstacle is detected in front of your vehicle

Braking assistance is then ended.

Blind Spot Assist

General notes

Blind Spot Assist monitors the areas on either side of the vehicle that are not visible to the driver with two lateral, rear-facing radar sensors in the bumper. It supports you from speeds of approximately 20 mph (30 km/h). A warning display in the exterior mirrors draws your attention to vehicles detected in the monitored area. If you then switch on the corresponding turn signal to change lane, you will also receive an optical and audible collision warning.

Important safety notes

WARNING

Blind Spot Assist does not react to:

- vehicles overtaken too closely on the side, placing them in the blind spot area
- vehicles which approach with a large speed differential and overtake your vehicle

As a result, Blind Spot Assist may not give warnings in such situations. There is a risk of an accident.

Always observe the traffic conditions carefully, and maintain a safe lateral distance.

Blind Spot Assist is only an aid. It may fail to detect some vehicles and is no substitute for attentive driving. Always ensure that there is sufficient distance to the side for other road users and obstacles.

In particular, the detection of obstacles can be impaired in the case of:

- dirt on the sensors or anything else covering the sensors
- fog, heavy rain or snow
- narrow vehicles, e.g. motorcycles or bicycles
- very wide lanes
- narrow lanes
- vehicles not driving in the middle of their lane
- barriers or other road boundaries

Vehicles in the monitoring range are then not indicated.

i USA only:

This device has been approved by the FCC as a "Vehicular Radar System". The radar sensor is intended for use in an automotive radar system only. Removal, tampering, or altering of the device will void any warranties, and is not permitted by the FCC. Do not tamper with, alter, or use in any non-approved way.

Any unauthorized modification to this device could void the user's authority to operate the equipment.

Monitoring range of the sensors

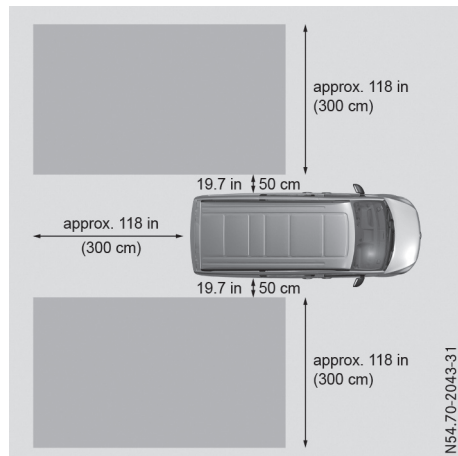

Blind Spot Assist monitors the area shown in the diagram up to 118 in (3 m) behind and directly next to your vehicle.

If the lanes are narrow, vehicles driving in the lane beyond the lane next to your vehicle may be indicated, especially if the vehicles are not driving in the middle of their lane. This may be the case if the vehicles are driving on the inner side of their lane.

Due to the nature of the system:

- warnings may be issued in error when driving close to crash barriers or similar solid lane borders.
- warnings may be interrupted when driving alongside long vehicles, for example trucks, for a prolonged time

The two sensors for Blind Spot Assist are integrated into the sides of the rear bumper. Make sure that the bumper is free of dirt, ice or slush in the vicinity of the sensors. The radar sensors must not be covered, for example by rear-mounted cycle racks or overhanging loads. Following a severe impact or in the event of damage to the bumper, have the function of the radar sensors checked at a qualified specialist workshop. Blind Spot Assist may otherwise not work properly.

Warning display

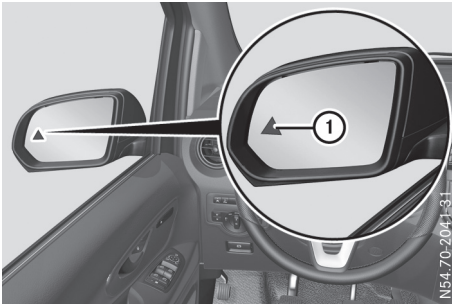

Blind Spot Assist is not active at speeds below approximately 20 mph (30 km/h). Vehicles in the monitoring range are then not indicated.

If a vehicle is detected within the monitoring range of Blind Spot Assist at speeds above approximately 20 mph (30 km/h), warning lamp ① lights up red in the exterior mirror on the corresponding side. Warning lamp ① always lights up when a vehicle enters the blind spot monitoring range from behind or from the side. When you overtake a vehicle, the warning only occurs if the difference in speed is less than 7 mph (11 km/h).

If you select reverse gear, Blind Spot Assist is inactive.

The intensity of warning lamps ① depends on the brightness of the ambient light and is controlled automatically.

Collision warning

If a vehicle is detected in the monitoring range of Blind Spot Assist and you switch on the corresponding turn signal, a double warning tone sounds once. The warning lamp in the corresponding exterior mirror flashes. If the turn signal remains on, detected vehicles are indicated by the flashing of the warning lamp in the exterior mirror. There are no further warning tones.

Activating Blind Spot Assist

- ▶ Make sure that Blind Spot Assist is activated in the on-board computer (> page 185).
- ▶ Turn the key to position **2** in the ignition lock. The warning lamps in the exterior mirrors light up for approximately 1.5 seconds.

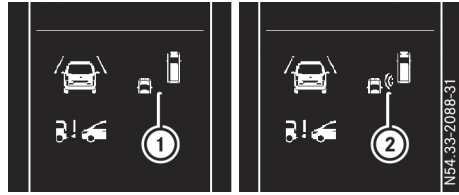

Status indicators in the status overview submenu

If Blind Spot Assist is activated, the display shows symbol ① in the **Status Overview** submenu of the on-board computer (> page 184). If you are driving faster than 20 mph (30 km/h), the symbol also shows radar waves ② between the two vehicles. Blind Spot Assist is then ready for use.

Towing a trailer

If you attach a trailer, make sure that you have correctly established the electrical connection. This can be accomplished by checking the trailer lighting. Blind Spot Assist is then deactivated and the **Blind Spot Assist Currently Unavail.** See **Operator's Manual** message appears in the display.

Lane Keeping Assist

General notes

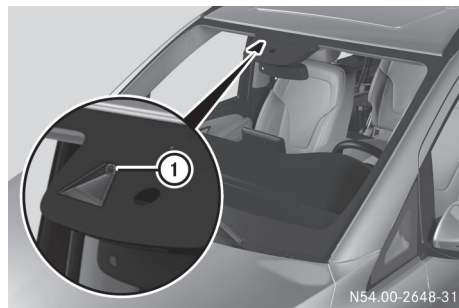

Lane Keeping Assist monitors the area in front of your vehicle by means of camera ① which is mounted at the top of the windshield. Lane Keeping Assist detects lane markings on the road and can warn you before you leave your lane unintentionally.

This function is available in the range between 40 mph (60 km/h) and 125 mph (200 km/h).

A warning may be given if a front wheel touches a lane marking. It will warn you by means of

intermittent vibration through the steering wheel for up to 1.5 seconds.

Important safety notes

WARNING

Lane Keeping Assist may not always clearly recognize lane markings.

In this case, Lane Keeping Assist may:

- give an unnecessary warning
- not give a warning

There is a risk of an accident.

Always pay particular attention to the traffic situation and stay in lane, in particular if warned by Lane Keeping Assist.

WARNING

The Lane Keeping Assist warning does not return the vehicle to the original lane. There is a risk of an accident.

You should always steer, brake or accelerate yourself, in particular if warned by Lane Keeping Assist.

If you fail to adapt your driving style, Lane Keeping Assist can neither reduce the risk of accident nor override the laws of physics. Lane Keeping Assist cannot take into account road, weather or traffic conditions. Lane Keeping Assist is only an aid. You are responsible for the distance to the vehicle in front, for vehicle speed, braking in good time and for staying in your lane.

Lane Keeping Assist does not keep your vehicle in its lane.

The system may be impaired or may not function if:

- there is poor visibility, e.g. due to insufficient illumination of the road, or due to snow, rain, fog or spray
- there is glare, e.g. from oncoming traffic, the sun or reflection from other vehicles (e.g. if the road surface is wet)
- the windshield is dirty, fogged up, damaged or covered, for instance by a sticker, in the vicinity of the camera
- there are no lane markings, or several unclear lane markings for one lane, e.g. around construction sites

- the lane markings are worn away, dark or covered up, e.g. by dirt or snow
- the distance to the vehicle in front is too short and thus the lane markings cannot be detected
- the lane markings change quickly, e.g. lanes branch off, cross one another or merge
- the road is narrow and winding
- there are highly variable shade conditions on the road

Deactivating and activating Lane Keeping Assist



- ▶ Press the  button.

If the indicator lamp in the button lights up and the display shows the  symbol in the status area, Lane Keeping Assist is switched on but not ready for use.

If you are driving with Lane Keeping Assist activated at speeds above 40 mph (60 km/h) and lane markings are detected, the display shows the  symbol highlighted in the status area. Lane Keeping Assist is then ready for use.

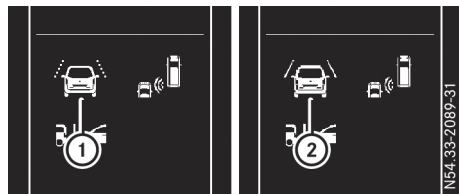

Status indicators in the status overview submenu

The display in the **Status Overview** submenu of the on-board computer also shows the status of Lane Keeping Assist (▶ page 184). If Lane Keeping Assist is activated but not ready for use, the display shows the lane markings in the symbol as broken lines ①. If Lane Keeping Assist is

ready for use, the lane markings in the symbol are shown as solid lines ②.

Setting the sensitivity of Lane Keeping Assist

- ▶ In the **Assist.** menu on the on-board computer, select the **Lane Keeping Assist:** function (▷ page 185).
- ▶ Select **Standard** or **Adaptive**.

In the setting **Standard**, no warning vibration occurs if:

- you operate the turn signal in the corresponding direction. In this event, the warnings are suppressed for a certain period of time.
- a driving safety system, such as ABS, BAS or ESP®, intervenes or performs a control action.

When **Adaptive** is selected, there is also no warning vibration when:

- you accelerate hard, e.g. kickdown.
- brake sharply.
- you steer actively, e.g. swerve to avoid an obstacle or change lanes quickly.
- you cut the corner on a sharp bend.

In order that you are warned only when necessary and in good time if you cross the lane marking, the system differentiates between various conditions and warns you accordingly.

The warning vibration occurs earlier if:

- you approach the outer lane marking on a bend.
- the road has very wide lanes, such as a highway.
- the system detects solid lane markings.

The warning vibration occurs later if:

- the road has narrow lanes.
- you cut the corner on a bend.

Alertness Assistant ATTENTION ASSIST

General notes

ATTENTION ASSIST helps you during long, monotonous journeys such as on freeways and interstate highways. It is active in the 40 mph (60 km/h) to 125 mph (200 km/h) range. If ATTENTION ASSIST detects typical indicators of

fatigue or increasing lapses in concentration on the part of the driver, it suggests taking a break.

Important safety notes

ATTENTION ASSIST is only an aid. The system may not always detect fatigue or lapses in concentration until too late, or may not detect them at all. ATTENTION ASSIST is not a substitute for a well-rested and attentive driver.

The functionality of ATTENTION ASSIST is restricted, and warnings may be delayed or not occur at all:

- if the length of the journey is less than approximately 30 minutes
- if the road condition is poor, e.g. if the surface is uneven or if there are potholes
- if there is a strong side wind
- if you have adopted a sporty driving style with high cornering speeds or high rates of acceleration
- if you are predominantly driving at a speed below 40 mph (60 km/h) or above 125 mph (200 km/h)
- if the time has been set incorrectly
- in active driving situations, such as when you change lanes or change your speed

ATTENTION ASSIST is reset and starts assessing your attention again when you continue your journey if:

- you switch off the engine
- you take off your seat belt and open the driver's door, e.g. for a change of drivers or to take a break

Displaying the attention level



For vehicles with steering wheel buttons you can have the current ATTENTION ASSIST (Attention Level) assessment displayed.

- ▶ Select **Status Overview** in the **Assist.** menu and display the attention level (▷ page 184).

The following information is displayed:

- the length of the journey since the last break.
- the attention level determined by ATTENTION ASSIST, displayed in a bar display in five levels from low to high.
- if ATTENTION ASSIST is unable to calculate the attention level and cannot output a warning, the **System Passive** message appears in the display. The bar display is then dimmed. This is the case, for example, if you are predominantly driving at a speed below 40 mph (60 km/h) or above 125 mph (200 km/h).

Activating ATTENTION ASSIST



- ▶ Activating ATTENTION ASSIST with the on-board computer:
 - on vehicles without steering wheel buttons (▷ page 175)
 - on vehicles with steering wheel buttons (▷ page 185)

For vehicles with steering wheel buttons, the system determines the attention level of the driver depending on the setting selected:

Standard: the sensitivity with which the system determines the attention level is set to normal.

Sensitive: the sensitivity is set higher. The driver is warned earlier.

When ATTENTION ASSIST is switched on and the vehicle engine is running:

- on vehicles without steering wheel buttons, the  indicator lamp in the instrument cluster lights up
- on vehicles with steering-wheel buttons, the display shows the  symbol:
 - in the status area
 - in the **Status Overview** of the **Assist.** menu (▷ page 184)

For vehicles with steering wheel buttons, if you deactivate ATTENTION ASSIST, the system is automatically re-activated when you start the engine. The system sensitivity then corresponds to the last selection activated – standard or sensitive.

If you switch off ATTENTION ASSIST in a vehicle without steering wheel buttons, the system remains switched off even after you start the

engine. The status of the system after switching on the engine always corresponds to the status last selected.

Warning in the display

If the system detects tiredness or increasing lapses in concentration, the warning **Attention Assist: Take a Break!** or **Attent. Asst: Take Break!** is shown in the display.

An additional warning tone sounds.

- ▶ If necessary, take a break.
- ▶ Confirm the message by pressing the  button on the steering wheel.

On long journeys, take regular breaks in good time to allow yourself to rest. If you do not take a break and ATTENTION ASSIST continues to detect increasing lapses in concentration, you will be warned again after 15 minutes at the earliest. This will only happen if ATTENTION ASSIST still detects typical indicators of fatigue or increasing lapses in concentration.

PARKTRONIC

General notes

PARKTRONIC is an electronic parking aid. The system is equipped with ultrasonic sensors in the front and rear bumpers to monitor the area around your vehicle. PARKTRONIC indicates visually and audibly the distance between your vehicle and an object.

Your vehicle features two separate sound emitters with different frequencies for the warning tones. The warning ranges in front of and behind the vehicle are indicated by different warning tones.

PARKTRONIC is activated automatically when you:

- turn the key to position **2** in the ignition lock
- release the parking brake and
- move the selector lever to position **D**, **N** or **R**

PARKTRONIC is deactivated at speeds above 11 mph (18 km/h). PARKTRONIC is reactivated at speeds below 10 mph (16 km/h).

Important safety notes

PARKTRONIC is only an aid. It cannot replace your own awareness of the immediate surroundings. You are responsible for safe maneuvering,

parking and pulling away. Make sure that there are no persons, animals or objects in the maneuvering area while maneuvering and parking in/leaving parking spaces.

! Pay particular attention to obstacles above or below the sensors when parking, such as flower pots or trailer towbars. PARKTRONIC does not recognize such objects when they are in the immediate vicinity of the vehicle. You could damage the vehicle or objects.

PARKTRONIC can suffer interference from:

- ultrasonic sources such as a truck's compressed-air brakes, an automatic car wash or a pneumatic drill
- attachments to the vehicle, e.g. rear mounted racks
- number plates (vehicle license plates) that are not affixed flat against the bumper
- dirty or icy sensors

Remove a detachable trailer coupling if it is no longer required. PARKTRONIC measures the minimum detection range to an obstacle from the bumper, not the ball coupling.

Range of the sensors

PARKTRONIC does not account for obstacles that are:

- beneath its detection range, e.g. persons, animals or objects
- above its detection range, e.g. overhanging loads, overhangs or truck loading ramps

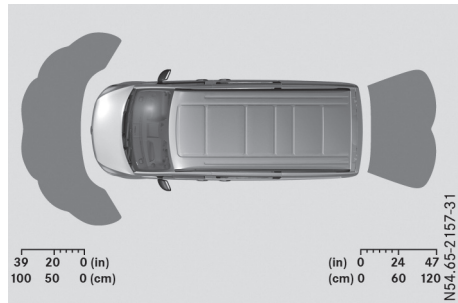
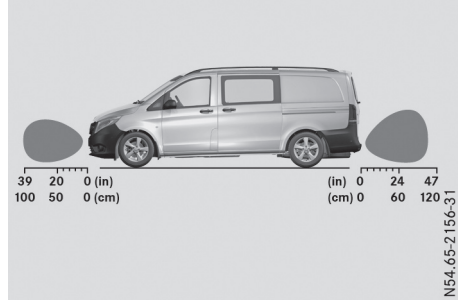

The sensors must be free of dirt, ice or slush. Otherwise, they cannot function correctly. Clean the sensors regularly, taking care not to scratch or damage them (▷ page 266).

Front sensors

Center	Approx. 39 in (100 cm)
Corners	Approx. 24 in (60 cm)

Rear sensors

Center	Approx. 47 in (120 cm)
Corners	Approx. 31 in (80 cm)

Minimum distance

Center	Approx. 8 in (20 cm)
Corners	Approx. 8 in (20 cm)

If an obstacle is within this range, the corresponding segments of the warning displays light up and you hear a warning tone. If the distance falls below the minimum, the distance from an obstacle may no longer be shown.

Warning displays

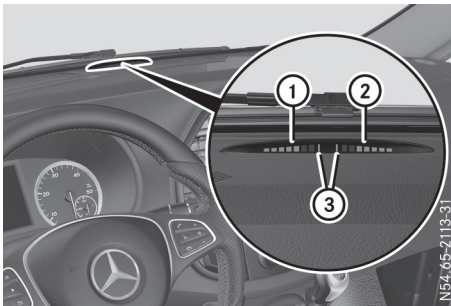

Front area warning display in center of dashboard.

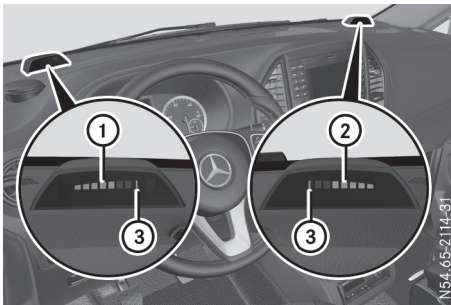

Rear area warning display on the dashboard

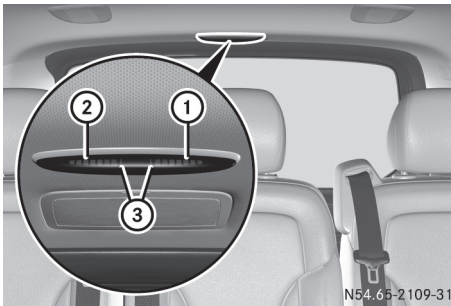

Rear area warning display in center of headliner in rear compartment.

- ① Warning segments for the left side of the vehicle
- ② Warning segments for the right side of the vehicle
- ③ Segments showing operational readiness

The warning displays show the distance between the sensor and the obstacle. The warning display is divided into five yellow and two red segments for each side of the vehi-

cle. PARKTRONIC is operational if operational readiness indicator ③ lights up.

There is a malfunction if only the red segments of the warning display light up (▷ page 154).

The selected transmission position determines whether the front and/or rear area is monitored.

Selector lever position	Monitoring
D	Front area
R or N	Front and rear area
P	No areas activated

One or more segments light up as the vehicle approaches an obstacle, depending on the vehicle's distance from the obstacle.

From the:

- sixth segment, an intermittent warning tone sounds for approximately two seconds.
- seventh segment, a continuous warning tone sounds. This indicates that you have now reached the minimum distance.

Roll-back warning

Regardless of transmission position, PARKTRONIC automatically monitors the area behind the vehicle if the vehicle begins to roll backwards, e.g. after stopping on an uphill gradient.

Activating/deactivating PARKTRONIC

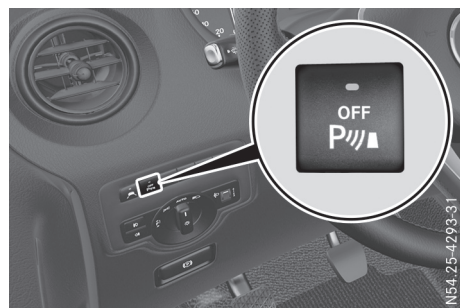

- ▶ Press the  button. If PARKTRONIC is deactivated, the indicator lamp in the switch lights up.

Towing a trailer

PARKTRONIC detects a coupled trailer if your vehicle is equipped with the corresponding electrical installations for trailer towing.

PARKTRONIC is deactivated for the rear area when you establish an electrical connection

between your vehicle and a trailer. If you use an adapter for the socket, remove it from the socket after detaching the trailer. Otherwise, PARKTRONIC remains deactivated for the rear area.

Problems with PARKTRONIC

Problem	Possible causes/consequences and ► Solutions
<p>Only the red segments in the PARKTRONIC warning displays are lit. In addition, a warning tone sounds for approx. two seconds. PARKTRONIC is then deactivated. The indicator lamp of the  button lights up and the red segments in the PARKTRONIC warning display go out.</p>	<p>PARKTRONIC has malfunctioned and has switched itself off.</p> <ul style="list-style-type: none"> ► If problems persist, have PARKTRONIC checked at a qualified specialist workshop.
<p>The PARKTRONIC warning displays implausible distances. For example, all the segments may be lit even though there is no obstacle present.</p>	<p>The PARKTRONIC sensors are dirty or iced up.</p> <ul style="list-style-type: none"> ► Clean the PARKTRONIC sensors (▷ page 266). ► Turn the key to position 2 in the ignition lock.
	<p>The license plate or other parts attached near the sensors may not be secured correctly.</p> <ul style="list-style-type: none"> ► Check the license plate and attachment parts near the sensors for correct seating.
	<p>An external radio or ultrasonic source may be causing interference.</p> <ul style="list-style-type: none"> ► Check PARKTRONIC functions in a different location.

Active Parking Assist

General notes

Active Parking Assist is an electronic parking aid. The system uses ultrasound sensors to measure the road on both sides of the vehicle and indicates suitable parking spaces. It can then actively steer and brake the vehicle to help you to park and exit the parking space.

Active Parking Assist includes the PARKTRONIC parking aid which indicates visually and audibly the distance between your vehicle and an object. To do this, PARKTRONIC uses the ultra-

sonic sensors of the Active Parking Assist (▷ page 151).

Important safety notes

Active Parking Assist is only an aid. It is not a substitute for your attention to the immediate surroundings. You are responsible for safe maneuvering, parking and pulling away. Make sure that no persons, animals or objects are in the maneuvering range.

When you deactivate PARKTRONIC, Active Parking Assist will also be deactivated.

For vehicles with a trailer coupling installed, the minimum length for parking spaces will be slightly increased.

If you have attached a trailer to your vehicle, you should not use Active Parking Assist. Once the electrical connection is established between your vehicle and the trailer, Active Parking Assist is no longer available. PARKTRONIC is then deactivated for the rear area.

WARNING

While parking or pulling out of a parking space, the vehicle swings out and can drive onto areas of the oncoming lane. This could result in a collision with another road user. There is a risk of an accident.

Pay attention to other road users. Stop the vehicle if necessary or cancel the Active Parking Assist parking procedure.

- !** If unavoidable, you should drive over obstacles such as curbs slowly and not at a sharp angle. Otherwise, you may damage the wheels or tires.

Active Parking Assist may also display spaces not suitable for parking, e.g.:

- in a zone where parking or stopping is prohibited
- in front of driveways or entrances and exits
- on unsuitable surfaces

Parking tips:

- on narrow roads, drive as closely as possible past the parking space.
- parking spaces that are littered or overgrown might be identified or measured incorrectly.
- parking spaces that are partially occupied by trailer drawbars might not be identified as such or be measured incorrectly.
- snowfall or heavy rain may lead to a parking space being measured inaccurately.
- when transporting a load which protrudes from your vehicle, you should not use Active Parking Assist.
- never use Active Parking Assist when snow chains are installed.
- always ensure that the tire pressure is correct. This has a direct influence on the parking characteristics of the vehicle.

- if you mount wheels with a different wheel size, this will have a direct influence on the parking result.
- if you mount tires from another manufacturer, this may have an influence on the parking result.
- if you drive slowly past the parking space, a better parking result is achieved.
- pay attention to the PARKTRONIC warning messages (▷ page 153) during the parking procedure.
- you can intervene in the steering procedure to correct it at any time. Parking assistance will then be canceled and Active Parking Assist stopped.

Use Active Parking Assist for parking spaces that are:

- parallel or at right angles to the direction of travel.
- on straight roads, not bends.
- on the same level as the road, e.g. not on the pavement.

Detecting parking spaces

WARNING

If there are objects above the detection range:

- Active Park Assist may steer too early
- the vehicle may not stop in front of these objects

You may cause a collision as a result. There is a risk of an accident.

If objects are located above the detection range, stop and deactivate Active Parking Assist.

Objects located above the height range of Active Parking Assist will not be detected when the parking space is measured. These are not taken into account when the parking procedure is calculated, e.g. overhanging loads, overhangs or truck loading ramps.

For further information on the detection range (▷ page 152).

Active Parking Assist does not assist you parking in spaces at right angles to the direction of travel if:

- two parking spaces are located directly next to one another
- the parking space is directly next to a low obstacle such as a low curb
- you forward park

Active Parking Assist does not assist you parking in spaces that are parallel or at right angles to the direction of travel if:

- the parking space is on a curb
- the system reads the parking space as being blocked, for example by foliage or grass paving blocks
- the area is too small for the vehicle to maneuver into
- the parking space is bordered by an obstacle, e.g. a tree, a post or a trailer

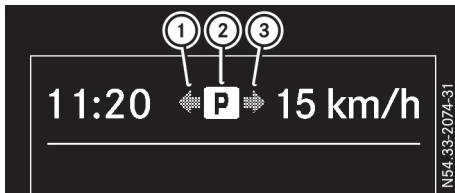

- ① Detected parking space on the left
- ② Parking symbol
- ③ Detected parking space on the right

If the driver's seat belt is fastened and all doors are closed, Active Parking Assist is activated automatically when driving forwards. The system is operational at speeds of up to approximately 22 mph (35 km/h). While in operation, the system independently locates and measures parking spaces on both sides of the vehicle. Active Parking Assist will only detect parking spaces:

- parallel or at right angles to the direction of travel
- that are parallel to the direction of travel and are at least 59 in (1.5 m) wide
- that are parallel to the direction of travel and at least 40 in (1.0 m) longer than your vehicle
- that are at right angles to the direction of travel and at least 40 in (1.0 m) wider than your vehicle

- i** Note that Active Parking Assist cannot measure the length of a parking space if it is at

right angles to the direction of travel. You will need to judge whether your vehicle will fit in the parking space.

When the vehicle is driving at speeds of up to approximately 20 mph (30 km/h), parking symbol ② is shown as a status display in the header.

The system detects and differentiates between parking spaces which are parallel or at right angles to the direction of travel. When a parking space is detected, an arrow appears next to parking symbol ② to indicate which side the parking space is on. The parking space is displayed while you are driving past it and until you are approximately 50 ft (15 m) away from it.

Active Parking Assist displays parking spaces on the passenger side as standard. The parking spaces on the driver's side are only displayed if you operate the turn signal on the driver's side. When parking on the driver's side, you must operate the turn signal until you have started active parking assistance by pressing the **OK** button on the steering wheel.

Parking

⚠ WARNING

If you leave the driver's seat when the vehicle is only being braked by Active Parking Assist, the vehicle could roll away if:

- there is a malfunction in the system or in the voltage supply.
- the electrical system in the engine compartment, the battery or the fuses are tampered with.
- the battery is disconnected.
- the vehicle is accelerated, e.g. by a vehicle occupant.

There is a risk of an accident.

Before leaving the driver's seat, always secure the vehicle against rolling away.

If PARKTRONIC detects obstacles, Active Parking Assist brakes automatically during the parking process. You are responsible for braking in good time.

- ▶ Bring the vehicle safely to a stop when the parking symbol shows the desired parking space in the instrument cluster.
- ▶ Shift the transmission to position **R**.
The display shows the **Start Park Assist? Yes: OK No:**  message and the location of the parking space.

- ▶ **To cancel the process:** press the  button on the steering wheel or drive off.

or

- ▶ **To park using active parking assistance:** press the  button on the steering wheel. The display shows the **Park Assist Active: Accelerate and Brake Obs. Surroundings** message.
- ▶ Let go of the steering wheel.
- ▶ Reverse the vehicle, being ready to brake at all times. Exit the parking space slowly and do not drive faster than 6 mph (10 km/h). Otherwise parking assistance is canceled and Active Parking Assist is stopped. Active Parking Assist brakes the vehicle to a standstill when the vehicle approaches the rear border of the parking space.

Maneuvering may be required in tight parking spaces. The display shows the **Park Assist Active: Select D Obs. Surroundings** message.

- ▶ While the vehicle is stationary, shift the transmission to position **D**. Active Parking Assist immediately steers in the other direction. The display shows the **Park Assist Active: Accelerate and Brake Obs. Surroundings** message.
- ▶  You will achieve the best results by waiting for the steering procedure to complete before pulling away.
- ▶ Drive forwards and be ready to brake at all times. Active Parking Assist brakes the vehicle to a standstill.

The **Park Assist Active: Select R Obs. Surroundings** message is shown in the display. As soon as the parking procedure is complete, the **Park Assist Finished** message appears in the display and a tone sounds. The parking assistance function of Active Parking Assist is stopped. The vehicle is parked and kept stationary without the driver having to depress the brake pedal. The braking effect is canceled when you depress the accelerator pedal.

Active Parking Assist no longer supports you with steering interventions and brake applications. Once active parking assistance has been stopped, you must steer and brake again yourself. PARKTRONIC is still available.

Parking tips:

- The way your vehicle is positioned in the parking space after parking is dependent on various factors. These include the position and shape of the vehicles parked in front and behind it and the conditions of the location. It may be the case that Active Parking Assist guides you too far into a parking space, or not far enough into it. In some cases, it may also lead you across or onto the curb. In this case, cancel the active parking assistance.
- You can also select transmission position **D** prematurely. The vehicle redirects and does not drive as far into the parking space. If you change direction too early, parking assistance is canceled and Active Parking Assist is stopped. It is then not possible to achieve a sensible parking position from the current position.

Exiting a parking space

In order that Active Parking Assist can assist you when exiting the parking space:

- the border of the parking space must be high enough at the front and the rear. A curb is too small, for example.
- the border of the parking space must not be too wide. Your vehicle can be maneuvered into a position at a maximum of 45° to the starting position in the parking space.
- a maneuvering distance of at least 3.3 ft (1.0 m) must be available.

Active Parking Assist can only assist you with exiting a parking space if you have parked the vehicle parallel to the direction of travel using Active Parking Assist.

If PARKTRONIC detects obstacles, Active Parking Assist brakes automatically when exiting from the parking space. You are responsible for braking in good time.

- ▶ Start the engine.
- ▶ Switch on the turn signal in the direction in which you are pulling away.
- ▶ Shift the transmission to position **D** or **R**. The display shows the **Start Park Assist? Yes: OK No:**  message.

► **To cancel the process:** press the  button on the steering wheel or drive off.

or

► **To exit the parking space using active parking assistance:** press the  button on the steering wheel. The display shows the **Park Assist Active: Accelerate and Brake Obs. Surroundings** message.

► Let go of the steering wheel.

► Pull away, being ready to brake at all times. Exit the parking space slowly and do not drive faster than 6 mph (10 km/h). Otherwise parking assistance is canceled and Active Parking Assist is stopped.

Active Parking Assist brakes the vehicle to a standstill when the vehicle approaches a border of the parking space.

► While the vehicle is stationary, shift the transmission to position **D** or **R** as required or according to the message.

Active Parking Assist immediately steers in the other direction. The display shows the **Park Assist Active: Accelerate and Brake Obs. Surroundings** message.

i You will achieve the best results by waiting for the steering procedure to complete before pulling away.

If you back up after activation, the steering wheel is moved to the straight-ahead position.

► Drive forwards and reverse as prompted by the PARKTRONIC warning displays, several times if necessary.

Once you have exited the parking space completely:

- The display shows the **Park Assist Finished** message.
- a tone sounds.
- the steering wheel is moved to the straight-ahead position.

The parking assistance function of Active Parking Assist is stopped. You will then have to steer and merge into traffic on your own. PARKTRONIC is still available.

You can take over the steering before the vehicle has exited the parking space completely. This is useful, for example when you recognize that it is already possible to pull out of the parking space.

Canceling active parking assistance

► Stop the movement of the steering wheel or steer yourself.

or

► Press the  button and deactivate PARKTRONIC (▷ page 153).

Parking assistance is canceled immediately and Active Parking Assist is stopped. The display shows the **Park Assist Canceled** message.

Active parking assistance is canceled automatically if:

- you apply the parking brake.
- parking using Active Parking Assist is no longer possible.
- you are driving faster than 6 mph (10 km/h).
- a wheel spins and ESP[®] intervenes or fails. The  warning lamp in the instrument cluster then lights up.
- you unfasten your seat belt.
- you open a door or the tailgate/rear door
- you shift the automatic transmission to position **P**

A warning tone sounds, the parking symbol in the display goes out and the **Park Assist Canceled** message appears.

Once active Parking Assist has been canceled, you must steer and brake again yourself.

If a system malfunction occurs, vehicles are automatically braked down to a standstill. To continue driving, you must depress the accelerator pedal again.

Rear view camera

General notes

On vehicles with a tailgate, the rear view camera is next to the tailgate handle (▷ page 267).

On vehicles with rear doors, the rear view camera is in the top of the license plate molding (▷ page 267).

The rear view camera is a visual parking aid. It shows you the area behind the vehicle in the audio display.

The area behind the vehicle is displayed in a mirrored fashion, as in the rear-view mirror or the exterior mirrors. The guide lines displayed assist you in backing up.

The message displays depend on the language setting of the audio system. The following rear view camera displays are examples.

Important safety notes

I Objects that are not at ground level appear further away than they actually are, for example:

- the bumper of the vehicle parked behind
- the drawbar of a trailer
- the ball coupling of a trailer tow hitch
- the tail-end of a truck
- slanted posts

Only use the camera guide lines for orientation. Do not get any closer to objects than the lowest horizontal guide line. You may otherwise damage your vehicle and/or the object.

The rear view camera is only an aid. It cannot replace your own awareness of the immediate surroundings. You are responsible for safe maneuvering and parking. Make sure that there are no persons, animals or objects in the maneuvering area while maneuvering and parking in parking spaces.

The rear view camera may show obstacles in perspectival distortion, incorrectly or not at all. The rear view camera cannot display all objects located very near and/or under the rear bumper. It does not warn you of a collision, persons or objects.

Under the following circumstances, the rear view camera will not function, or will function in a limited manner:

- if the tailgate or rear door is open.
- if it is raining very heavily or snowing, or it is foggy.
- at night or in very dark places.
- if the camera is exposed to very bright light. White lines may appear in the camera image.
- if the area is lit by fluorescent light or LED lighting. The camera image may flicker.
- if the camera lens fogs up, e.g. when driving into a heated garage in winter, causing a rapid change in temperature.
- if the camera lens is dirty or obstructed. Observe the notes on cleaning (▷ page 267).
- if the rear of the vehicle is damaged. In this case, have the camera position and setting checked at a qualified specialist workshop.

Do not use the rear view camera in these situations. You could otherwise injure others or damage objects and the vehicle while parking and maneuvering.

The field of vision and other functions of the rear view camera may be restricted due to additional accessories on the rear of the vehicle (e.g. license plate holder, rear-mounted bicycle rack).

Guide lines are always shown at road level. In trailer mode, the guide lines are shown at the level of the trailer coupling.

If you change wheel size, make sure they correspond to the correct wheel size category (▷ page 277). If the category is changed without recoding the control units in the vehicle, the rear view camera cannot be precisely calibrated. The guide lines at road level or at the level of the trailer tow hitch will not be displayed correctly.

In vehicles with a tailgate, the rear view camera is protected from raindrops and dust by means of a flap. When the rear view camera is activated, this flap opens.

The flap closes again when:

- you have finished the maneuvering process
- you switch off the engine

For technical reasons, the flap may remain open briefly after the rear view camera has been deactivated.

Switching the rear view camera on or off

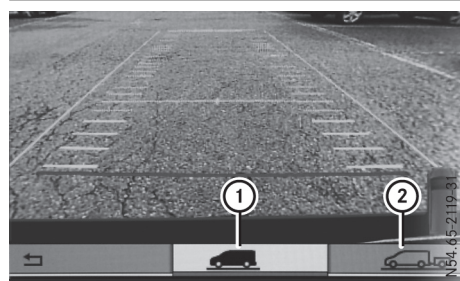

► **To switch on:** make sure that the key is in position **2** in the ignition lock.

► Shift the transmission to position **R**. On vehicles with a tailgate, the rear view camera flap opens. The audio display shows the area behind the vehicle. The rear area shown is divided by guide lines.

In vehicles with a trailer coupling installed, the function mode of the rear view camera can be switched over when the trailer is reached. The rear view camera then changes the viewing angle and shows a locating aid for the ball coupling of the trailer tow hitch to help reach the drawbar.

- ▶ **To switch function mode:** select and confirm "Reverse parking" function ① or "Coupling up a trailer" function ② using the audio system control knob.

Information on the audio system control knob can be found in the separate operating instructions.

The symbol of the selected function is highlighted.

- ▶ **To switch off:** shift the transmission to position **N** or **D**.

The dynamic guide lines are hidden and after about 15 seconds the rear view camera switches itself off.

or

- ▶ Drive forwards more than about 30 ft (10 m).

or

- ▶ Drive forwards faster than 6 mph (10 km/h).

or

- ▶ Shift the automatic transmission to **P**.

In vehicles with Active Parking Assist, the rear view camera remains switched on after the initial shift to reverse gear for the whole duration of active parking assistance. You can find information on active parking assistance under "Active Parking Assist" (> page 154).

Displays in the audio display

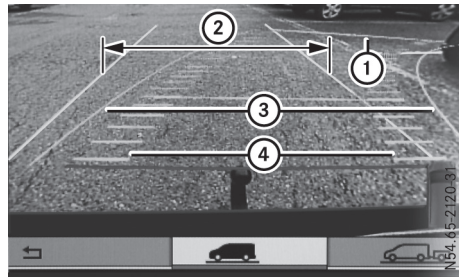

- ① Yellow guide line at a distance of approximately 13 ft (4.0 m) from the rear of the vehicle
- ② White guide line without turning the steering wheel, vehicle width including the exterior mirrors (static)
- ③ Yellow guide line for the vehicle width including the exterior mirrors, at the current steering angle (dynamic)
- ④ Yellow lane marking the course the tires will take at the current steering angle (dynamic)

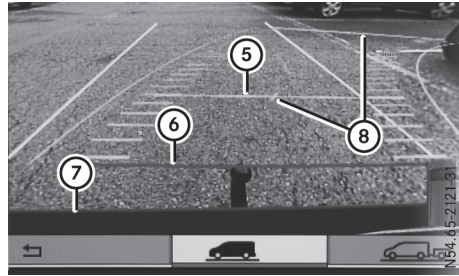

- ⑤ Yellow guide line at a distance of approximately 3 ft (1.0 m) from the rear of the vehicle
- ⑥ Red guide line at a distance of approximately 12 in (0.30 m) from the rear of the vehicle
- ⑦ Bumper
- ⑧ Vehicle center axis (locating aid)

The guide lines are shown when the transmission is in position **R**.

The distance specifications only apply to objects that are at ground level.

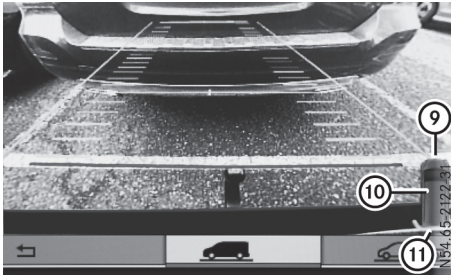

PARKTRONIC warning displays for vehicles with Active Parking Assist

- ⑨ Front warning displays
- ⑩ Vehicle symbol as PARKTRONIC measurement operational readiness indicator
- ⑪ Rear warning displays

When PARKTRONIC is switched on and is operational (▷ page 153) in vehicles with Active Parking Assist, the camera image shows vehicle symbol ⑩. When the PARKTRONIC warning displays go on, warning displays ⑨ and ⑪ light up accordingly as red or yellow brackets around vehicle symbol ⑩.

"Reverse parking" function

Backing up straight into a parking space without turning the steering wheel

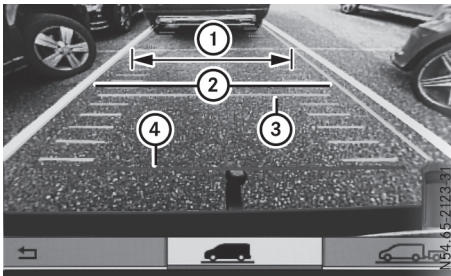

- ① White guide line without turning the steering wheel, vehicle width including the exterior mirrors (static)
- ② Yellow guide line for the vehicle width including the exterior mirrors, at the current steering angle (dynamic)
- ③ Yellow guide line at a distance of approximately 3 ft (1.0 m) from the rear of the vehicle
- ④ Red guide line at a distance of approximately 12 in (0.30 m) from the rear of the vehicle

- ▶ Make sure that the rear view camera is switched on (▷ page 159). The lane and the guide lines are shown.
- ▶ With the help of white guide line ①, check whether the vehicle will fit into the parking space.
- ▶ Using white guide line ① as a guide, carefully back up until you reach the end position. Red guide line ④ is then at the end of the parking space. The vehicle is almost parallel in the parking space.

Backing up into a perpendicular parking space with the steering wheel at an angle

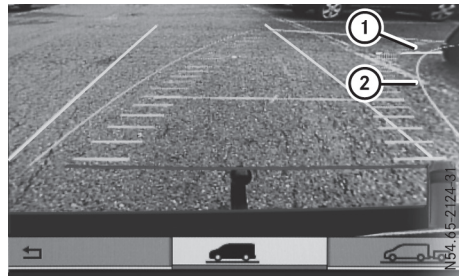

- ① Parking space marking
- ② Yellow guide line for the vehicle width including the exterior mirrors, at the current steering angle (dynamic)

- ▶ After driving past the parking space, stop the vehicle, paying attention to road and traffic conditions.
- ▶ Make sure that the rear view camera is switched on (▷ page 159). The lane and the guide lines are shown.
- ▶ While the vehicle is at a standstill, turn the steering wheel in the direction of the parking space until yellow guide line ② reaches parking space marking ①.
- ▶ Maintain the steering angle and reverse carefully.

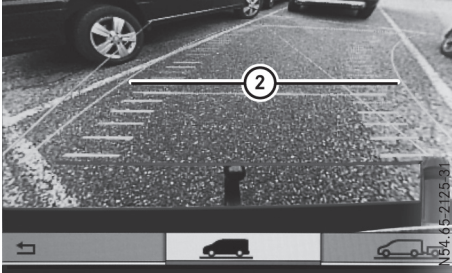

- ② Yellow guide line for the vehicle width including the exterior mirrors, at the current steering angle (dynamic)
- ▶ Stop the vehicle when it is almost exactly in front of the parking space. The white lane should be as close to parallel with the parking space marking as possible.

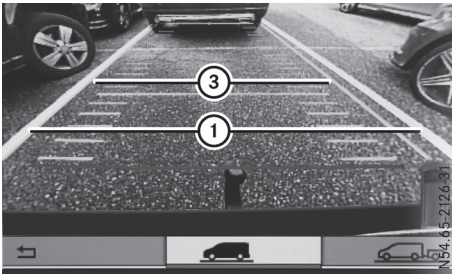

- ③ White guide line at current steering angle
① Parking space marking
- ▶ Turn the steering wheel to the center position while the vehicle is stationary.

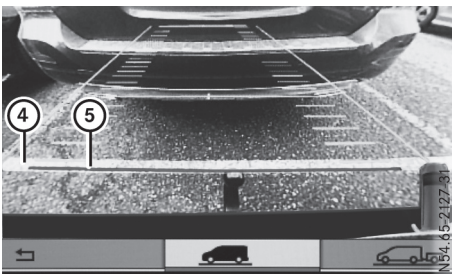

- ④ End of parking space
⑤ Red guide line at a distance of approximately 12 in (0.30 m) from the rear of the vehicle
- ▶ Back up carefully until you have reached the end position. Red guide line ⑤ is then aligned with the marking at the end of parking space ④. The vehicle is almost parallel in the parking space.

"Coupling up a trailer" function

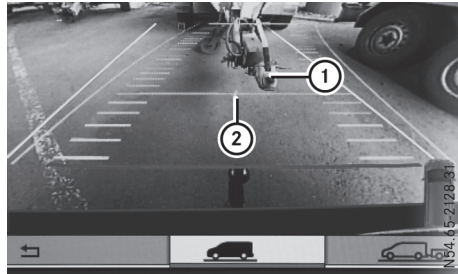

- ① Trailer drawbar
② Locating aid – vehicle center point on the yellow guide line at a distance of approximately 3 ft (1.0 m) from the rear of the vehicle

This function is only available on vehicles with a trailer tow hitch attached.

- ▶ Before coupling up the trailer, set the height of trailer drawbar ① so that it is slightly higher than the ball coupling.
- ▶ Position the vehicle centrally in front of trailer drawbar ①.

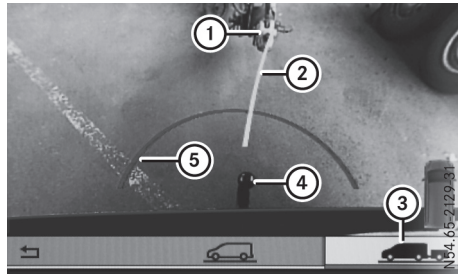

- ① Trailer drawbar
② Trailer drawbar locating aid
③ "Coupling up a trailer" function selected
④ Ball coupling
⑤ Red guide line at a distance of approximately 12 in (0.30 m) from the ball coupling
- ▶ Select and confirm "Coupling up a trailer" function ③ with the audio system control knob.

Information on the audio system control knob can be found in the separate operating instructions.

Symbol ③ is highlighted. The distance specifications now only apply to objects that are at the same level as the ball coupling.

- ▶ Back up carefully, making sure that trailer drawbar locating aid ② points approximately in the direction of trailer drawbar ①.
- ▶ Back up carefully until trailer drawbar ① reaches red guide line ⑤.
The distance between trailer drawbar ① and ball coupling ④ is now approximately 12 in (0.30 m).
- ▶ Couple the trailer (▶ page 163).

Towing a trailer

Notes on trailer towing

Important safety notes

WARNING

Installing an unsuitable ball coupling may result in overloading of the trailer tow hitch and the rear axle. This applies especially if the ball coupling in question is longer or angled differently. This could seriously impair the driving characteristics and the trailer can come loose. There is a risk of an accident.

You should only ever install a ball coupling that has the permissible dimensions and that is designed to meet your trailer-towing requirements. Do not modify the ball coupling or the trailer tow hitch.

WARNING

If you use a ball coupling that is not approved for your vehicle, it may cause excessive strain on the trailer tow hitch. This can cause damage to the vehicle and the trailer may come loose during the journey. The handling may be impaired and the rear axle may be overloaded. This may lead to an accident involving serious or even fatal injury.

Therefore note the following:

- Only install a ball coupling that is approved for your vehicle.
- Before the journey, make sure that the ball coupling is correctly installed and secured. To do this, observe the operating instructions of the ball coupling manufacturer.
- Do not make any modifications to the ball coupling or the trailer tow hitch.

You must observe the operating instructions of the trailer tow hitch or ball coupling manufacturer.

WARNING

If the ball coupling is not correctly installed and secured, it could come loose while driving and endanger other road users. There is a risk of an accident and injury.

Install and secure the ball coupling as described in the ball coupling manufacturer's installation instructions. Make sure that the ball coupling is correctly installed and secured before every journey.

WARNING

When the vehicle/trailer combination begins to lurch, you could lose control of it. The vehicle/trailer combination could even rollover. There is a risk of an accident.

On no account should you attempt to straighten up the vehicle/trailer combination by increasing the speed. Reduce vehicle speed and do not countersteer. Apply the brake as necessary.

You can attach carrier systems such as bicycle racks or load-bearing implements on the ball coupling. The maximum load-bearing capacity of 165 lb (75 kg) applies when using carrier systems on the ball coupling.

Always observe the operating instructions provided by the manufacturers of the trailer coupling and the ball coupling.

Couple and decouple the trailer carefully. When backing up the towing vehicle, make sure nobody is standing between the vehicle and the trailer.

A trailer which is incorrectly coupled to the towing vehicle could break away. A correctly coupled trailer must be positioned horizontally behind the towing vehicle.

Ensure that the following weights are not exceeded:

- the permissible noseweight
- the permissible trailer load
- the permissible rear axle load of the towing vehicle
- the maximum permissible gross vehicle weight of both the towing vehicle and the trailer
- the maximum permissible gross weight of vehicle/trailer combination

The applicable permissible values that may not be exceeded can be found:

- in your vehicle documents
- on the type plates for the trailer tow hitch
- on the type plates for the trailer
- on the vehicle identification plate (> page 303).

Where the values differ, the lowest is valid.

You will find the values approved by the manufacturer on the vehicle identification plates and those for the towing vehicle in the "Technical data" section (> page 314).

Your vehicle behaves differently with a trailer than without one.

The vehicle/trailer combination:

- is heavier
- is restricted in its acceleration and gradient-climbing capability
- has an increased braking distance
- is more susceptible to strong crosswinds
- requires more sensitive steering
- has a larger turning circle

This may impair the handling characteristics.

When towing a trailer, always adjust your speed to suit the road and weather conditions. Drive carefully. Maintain a safe distance.

If you require any further explanation regarding the information contained in the Operating Instructions, please contact a Mercedes-Benz Commercial Van Center.

General notes

- Observe the legally permitted maximum speed for vehicle/trailer combinations in the relevant country, state or Canadian province. Before beginning the journey, check the trailer's documents for the maximum permitted speed of your trailer.

This reduces the risk of accidents.

- Install only an approved trailer coupling on your vehicle. Only use a ball coupling for your Metris trailer tow hitch if it has been approved for your vehicle. More information on the availability, mounting and installation of the trailer electrics is available at any qualified specialist workshop.
- The trailer coupling is one of the most important vehicle parts with regard to road safety. Observe the notes on operation, care and maintenance of the trailer tow hitch (see the manufacturer's operating instructions).
- The bumpers of your vehicle are not suitable for installing detachable trailer couplings.
- Do not attach rented trailer tow hitches or other detachable trailer tow hitches to the bumper.
- Minimize the risk of damage to the ball coupling. If you do not require the ball coupling, remove it from the ball coupling recess.

You will find weight information under "Technical data" (> page 314).

The height of the ball neck changes according to the load on the vehicle. If this is the case, use a trailer with a height-adjustable trailer drawbar.

Driving tips

The maximum permissible speed for vehicle/trailer combination depends on the type of trailer. Before beginning the journey, check the trailer's documents for the maximum permitted speed of your trailer. Observe the legally permitted maximum speed in the relevant country, state or Canadian province.

When towing a trailer, your vehicle's handling characteristics will be different in comparison to when driving without a trailer and it will consume more fuel.

On long and steep downhill gradients, select a lower gear.

- **i** This also applies if cruise control is activated.

This enables you to utilize the engine's braking effect and you do not need to brake so heavily to keep the correct speed. This relieves the load on the brake system and prevents the brakes from overheating and wearing too quickly. If you need to brake additionally, do not depress the brake pedal constantly, but periodically.

Observe the notes on ESP® trailer stabilization (▷ page 67).

Driving tips

If the trailer begins to swing from side to side:

- ▶ Do not accelerate.
- ▶ Do not counter-steer.
- ▶ Brake if necessary.
- i** You can reduce the risk of the trailer swinging and rocking by retrofitting anti-roll bars or trailer stability programs. Further information is available at your authorized Mercedes-Benz Van Dealer.
- Maintain a greater distance than you would when driving without towing a trailer.
- Avoid sudden braking. Apply the brakes gently at first to allow the trailer brake to overrun. Then, increase the brake force quickly.
- The figures for the gradient climbing capabilities from a standstill refer to sea level. When driving in mountainous areas, note that the power output of the engine, and with it its gradient climbing capability, decrease with increasing altitude.

Coupling up a trailer

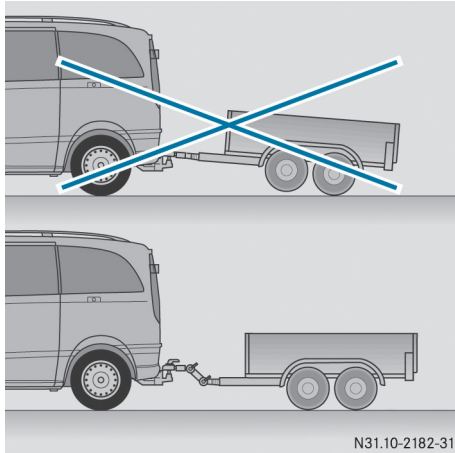

N31.10-2182-31

Trailer coupled ready for use

- ▶ Make sure that the selector lever of the automatic transmission is in position **P**.
- ▶ On vehicles with an automatic transmission, ensure that the transmission is in position **P**.
- ▶ Engage the vehicle's parking brake.
- ▶ Close all doors.
- ▶ Position the trailer horizontally behind your vehicle.
- i** The height of the ball neck changes according to the load on the vehicle. In this case, use a trailer with a height-adjustable trailer drawbar.
- ▶ Couple the trailer.
- ▶ Establish all electrical and other connections to the trailer. When doing so, hook the break-away cable of the trailer into the eyelet on the ball coupling.
- ▶ Remove the objects that are preventing the trailer from rolling, e.g. wheel chocks.
- ▶ Release the trailer parking brake.
- i** The subharness of the vehicle has a cable connection to the brake lamp indicator lamp.

Observe the maximum permissible trailer dimensions (width and length).

Most federal states and all Canadian provinces require by law:

- safety chains between the towing vehicle and the trailer. The chains should be cross-wound under the trailer drawbar. They must be fas-

tened to the vehicle's trailer coupling, not to the bumper or the axle.

Leave enough slack in the chains. This allows you to drive round tight corners.

- a separate brake system for certain types of trailer.
- a safety shut-off for braked trailers. Find out the specific requirements according to the applicable laws.

If the trailer becomes detached from the towing vehicle, the safety shut-off applies the trailer brakes.

Towing a trailer

There are numerous legal requirements concerning the towing of a trailer, e.g. speed restrictions. Many states require a separate functional braking system for your trailer once a certain weight limit is exceeded. For reasons of safety, it is recommended that all trailers use a separate functional braking system. Make sure your vehicle/trailer combination complies with local laws. This not only means where you live, but also anywhere you are driving to. Information on this can be obtained from the police and local authorities.

Observe the following when towing a trailer:

- Practice driving around bends, stopping and backing up at a place where there is no traffic. This enables you to gain experience and get used to the new handling characteristics.
- Before driving, check:
 - that the trailer tow hitch and ball coupling are secure
 - that the safety switch for a braked trailer is functioning properly
 - that the safety chains are secure and not damaged
 - that the electrical connections are secure
 - that the lights are working
 - that the wheels are in good order and the tire pressure is correct
- Adjust the exterior mirrors to provide an unobstructed view of the rear section of the trailer.
- If the trailer is equipped with a separate functional braking system, check before each journey whether the brakes are functioning correctly.

- Secure the load on the trailer according to the applicable specifications and current standards on securing loads (▷ page 244).

- When driving with a trailer, check at regular intervals that the load is secured and that the brakes and lights are working.

- Bear in mind that the handling will be less stable when towing a trailer than when driving without one. Avoid sudden steering movements.

- The vehicle/trailer combination is heavier, accelerates more slowly and has a decreased gradient climbing capability and a longer braking distance.

It is more susceptible to crosswinds and requires cautious steering.

- If possible, do not brake suddenly, but rather moderately at first so that the trailer can activate its brakes. Then increase the force on the brake pedal.

- If the automatic transmission repeatedly shifts between gears when driving on inclines, restrict the shift range. Select shift range **4**, **3**, **2** or **1**.

Driving in a low gear and at a low speed reduces the risk of damaging the engine.

- When driving on a downhill gradient, shift to a low gear and take advantage of the engine's braking effect.

Avoid continuous brake application as this may overheat the vehicle brakes and, if installed, the trailer brakes.

- If the coolant temperature increases dramatically while the air-conditioning system is switched on, switch off the air-conditioning system.

Coolant heat can also be dissipated by switching the airflow and the temperature of the air conditioning to the maximum level. Open the windows if necessary.

- When overtaking, pay particular attention to the extended length of your vehicle/trailer combination.

Due to the length of your vehicle/trailer combination you need an additional distance before you can return to your original lane.

Uncoupling a trailer

WARNING

If you uncouple a trailer with the overrun brake engaged, you could trap your hand between the vehicle and the trailer drawbar. There is a risk of injury.

Do not uncouple a trailer if the overrun brake is engaged.

-  Do not disconnect a trailer with an engaged overrun brake. Otherwise, your vehicle could be damaged by the rebounding of the overrun brake.
- ▶ Make sure that the selector lever of the automatic transmission is in position **P**.
- ▶ Engage the vehicle's parking brake.
- ▶ Close all doors.
- ▶ Apply the parking brake of the trailer.
- ▶ In addition, secure the trailer against rolling away with a wheel chock or similar object.
- ▶ Remove the trailer cable and safety chains and decouple the trailer.

Permissible trailer loads and trailer drawbar noseweights

Weight information

-  For vehicles with a permissible gross vehicle weight of 6724 lbs (3050 kg), the permissible gross combination weight is less than the sum of the permissible gross vehicle weight plus the permissible trailer load. Exceeding the permitted gross combination weight could damage the powertrain, transmission or trailer tow hitch.

If either the vehicle or the trailer is fully laden, the permitted gross vehicle weight or the permitted trailer load values are reduced accordingly. In this case, you may only partially load the trailer or the vehicle.

The gross trailer weight (GTW) is calculated by adding the weight of the trailer to the weight of the load and equipment. If the trailer is installed with a separate functional braking system, then the maximum gross trailer weight is 5000 lbs (2268 kg).

WARNING

If you tow a trailer without a separate functional braking system and a gross trailer weight (GTW) of more than 1635 lbs (750 kg), then the vehicle brake system may overheat. This increases the braking distance and the brake system may even fail. There is an increased risk of accident and injury, possibly even fatal.

Always use a trailer with a separate functional braking system when towing a trailer with a gross trailer weight (GTW) of more than 1635 lbs (750 kg).

The maximum noseweight of the trailer drawbar on the ball coupling is 500 lbs (227 kg). The actual noseweight may not exceed the value given on the identification plates of the trailer tow hitch or the trailer. If the values vary, the lowest value always applies.

The gross combination weight rating (GCWR) is calculated by adding the gross weight of the trailer to the gross vehicle weight including a driver's weight of approximately 150 lbs (68 kg). The permissible Gross Combination Weight Rating is vehicle-specific and depends on the equipment level.

When driving with a trailer, you should not exceed the permitted Gross Combination Weight Rating (GCWR).

The permissible values, which must not be exceeded, can be found in your vehicle documents and on the trailer tow hitch type plates for the trailer and the vehicle (> page 303). The basic values approved by the manufacturer can also be found in the "Technical data" section (> page 313). If the values vary, the lowest value always applies.

Loading a trailer

-  Utilize the maximum permissible noseweight as fully as possible. Do not allow the weight to fall below the minimum permissible noseweight, otherwise the trailer may come loose.
- The load must be distributed over the vehicle and the trailer so as not to exceed either the maximum permissible values for the gross vehicle weight rating (GVWR) and gross trailer weight (GTW), the gross combination weight

rating (GCWR), nor the maximum permissible gross axle weight rating (GAWR) and trailer drawbar noseweight rating of your vehicle.

- Add the drawbar noseweight on the ball coupling (TWR) to the rear axle load. This will prevent you from exceeding the permissible gross axle weight (GAWR).
- Add the drawbar noseweight on the ball coupling (TWR) to the vehicle payload. This will ensure that you do not exceed the permissible gross vehicle weight rating (GVWR).

Checking the vehicle and trailer weight

- Make sure the weights of the towing vehicle and the trailer comply with the maximum permissible values. Have the vehicle/trailer combination weighed on a calibrated weighbridge. The vehicle/trailer combination consists of the towing vehicle including the driver, passengers and load, as well as the loaded trailer.
- Check the maximum permissible gross axle weight rating of the front and rear axles (GAWR), the gross trailer weight (GTW), the gross combination weight rating (GCWR) and the noseweight of the trailer drawbar (TWR).

Trailer power supply

! Incorrect wiring of the connector plug could, under certain circumstances, cause malfunctions in the vehicle's other electronic systems. We therefore recommend having the connector plug wired at a qualified specialist workshop.

! You can connect accessories with a maximum power consumption of 240 W to the permanent power supply.
You must not charge a trailer battery using the power supply.

Your vehicle may be equipped with various electrical installations for trailer towing. Depending on your trailer, you may need an adapter to connect the electrical system of the trailer with that of the vehicle.

The trailer socket of your vehicle is equipped at the factory with a permanent power supply.

The permanent power supply is on the trailer socket pin assignment 4.

Note that the permanent power supply of the trailer is not switched off when the on-board

voltage is low. This can completely discharge the starter battery of your vehicle.

Further information on the electrical equipment currently installed on your vehicle and on installing trailer electrics can be obtained at any qualified specialist workshop.

Useful information

This Operator's Manual describes all models as well as standard and optional equipment of your vehicle that were available at the time of going to print. Country-specific variations are possible. Note that your vehicle may not be equipped with all of the described functions. This also applies to systems and functions relevant to safety.

Read the information on qualified specialist workshops (▷ page 31).

Important safety notes

WARNING

If you operate information systems and communication equipment integrated in the vehicle while driving, you will be distracted from traffic conditions. You could also lose control of the vehicle. There is a risk of an accident.

Only operate the equipment when the traffic situation permits. If you are not sure that this is possible, park the vehicle paying attention to traffic conditions and operate the equipment when the vehicle is stationary.

WARNING

If you are driving and reach through the steering wheel to operate the adjustment knob, you could lose control of the vehicle. There is a risk of an accident and injury.

Only operate the adjustment knobs when the vehicle is stationary. Do not reach through the steering wheel when driving.

You must observe the legal requirements for the country in which you are currently driving when operating the on-board computer.

WARNING

If the instrument cluster has failed or malfunctioned, you may not recognize function restrictions in systems relevant to safety. The operating safety of your vehicle may be impaired. There is a risk of an accident.

Drive on carefully. Have the vehicle checked at a qualified specialist workshop immediately.

The on-board computer display only shows messages and warnings from certain systems. You should therefore make sure your vehicle is operating safely at all times. If the operating safety of your vehicle is impaired, stop the vehicle as soon as possible, paying attention to road and traffic conditions. Then consult a qualified specialist workshop.

The accuracy of the speedometer and odometer displays is legally prescribed. Determining the speed is dependent on the wheel size or the rolling circumference of the wheels. If you change the wheel size on your vehicle, make sure it is assigned to the correct wheel size category (▷ page 277). If you change wheel size category without recoding the control unit, the speedometer indication will be inaccurate. Driving safety and driving systems may be impaired or detect a malfunction and shut down.

An overview of the instrument cluster can be found under "Instrument cluster":

- for vehicles without steering wheel buttons (▷ page 37)
- for vehicles with steering wheel buttons (▷ page 39)

Display and operation

Instrument lighting



Brightness control knob (example: vehicle with steering wheel buttons)

In daylight, the displays in the instrument cluster are illuminated. A dimming function is not possible in daylight.

On vehicles with steering wheel buttons, the light sensor in the instrument cluster automatically controls the brightness of the display lighting.

While the lights are on, the brightness is dependent upon the brightness of the ambient light. You can also adjust the brightness of the instrument lighting and the display lighting

- by pressing the \oplus and \ominus buttons on the instrument cluster on vehicles without steering wheel buttons (not in the **Settings** menu)
- by turning brightness control knob $\textcircled{1}$ on vehicles with steering wheel buttons

Speedometer

If you change the wheel size on your vehicle, make sure it is assigned to the correct wheel size category (▷ page 277). If you change wheel size category without recoding the control unit, the speedometer indication will be inaccurate. The current vehicle speed may then be higher than the speed displayed in the speedometer. The speed can also be shown in the display in the form of a digital speedometer:

- on vehicles without steering wheel buttons (▷ page 173)
- on vehicles with steering wheel buttons (▷ page 179)

i In some countries, a warning sounds and/or the display shows a message when the vehicle reaches the maximum legally permissible speed limit, e.g. at 75 mph (120 km/h).

Tachometer

! Do not drive in the overrevving range, as this could damage the engine.

\textcircled{P} Environmental note

Avoid driving at high engine speeds. This unnecessarily increases the fuel consumption of your vehicle and harms the environment as a result of increased emissions.

The red band in the tachometer indicates the engine's overrevving range.

To protect the engine, the fuel supply is interrupted when the red band is reached.

Outside temperature display

You should pay special attention to road conditions when temperatures are around freezing point.

Please bear in mind that the outside temperature display shows the air temperature measured and not the road temperature.

The display shows the outside temperature in the header:

- on vehicles without steering wheel buttons (▷ page 171)
- on vehicles with steering wheel buttons (▷ page 177)

Changes in the outside temperature are displayed after a short delay.

Coolant temperature gauge

\triangle WARNING

Opening the hood when the engine is overheated or when there is a fire in the engine compartment could expose you to hot gases or other service products. There is a risk of injury.

Let an overheated engine cool down before opening the hood. If there is a fire in the engine compartment, keep the hood closed and contact the fire department.

On vehicles without steering wheel buttons, you can have the coolant temperature shown in the display (▷ page 173).

On vehicles with steering wheel buttons, an analog coolant temperature gauge is located in the tachometer in the instrument cluster (▷ page 39).

Under normal operating conditions and with the specified coolant level, the gauge may rise to 248 °F (120 °C).

On-board computer (vehicles without steering wheel buttons)

Operating the on-board computer

Overview

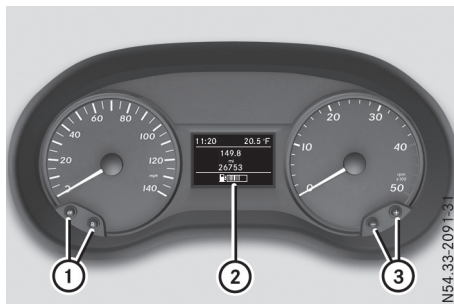

- ① and buttons
- ② Display
- ③ and buttons

► **To activate the on-board computer:** turn the SmartKey to position **1** in the ignition lock.

If you remove the SmartKey, then quickly re-insert it and turn to position **1**, the on-board computer and instrument cluster are not activated.

You can control the display and the settings in the on-board computer with buttons ① and ③ on the instrument cluster.

Buttons on the instrument cluster

WARNING

If you are driving and reach through the steering wheel to operate the adjustment knob, you could lose control of the vehicle. There is a risk of an accident and injury.

Only operate the adjustment knobs when the vehicle is stationary. Do not reach through the steering wheel when driving.

	<p>Press briefly:</p> <ul style="list-style-type: none"> • Selects the menu or display • In the Settings menu: exits the submenu without adopting the last setting and returns to the menu's start screen
	<p>Press and hold:</p> <ul style="list-style-type: none"> • Returns to the standard display or the Distance menu without adopting the last setting
	<p>Press briefly:</p> <ul style="list-style-type: none"> • Selects a submenu or function • Confirms the selected entry in the list or the display, or confirms the setting
	<p>Press and hold:</p> <ul style="list-style-type: none"> • Resets the trip odometer and trip computer values • In the start screen of the Settings menu: resets settings to the factory settings • In the Settings menu: resets values and returns to the menu's start screen
	<ul style="list-style-type: none"> • Sets the instrument cluster lighting (not in the Settings menu) • Scrolls through lists • Changes values or settings

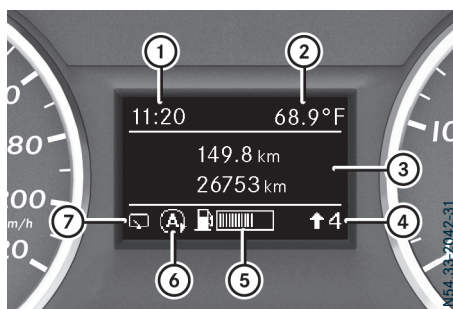

Display



Instrument cluster display

- ① Clock (► page 187)
- Cruise control (► page 142)
- ② Permanent display: outside temperature or speed (► page 175)

120 km/h! (only for certain countries) maximum permissible speed exceeded

- ③ Display panel for display messages, menus and menu bar
- ④ Transmission position (▷ page 127)
- ⑤ Fuel level
- ⑥  ECO start/stop function (▷ page 123)
- ⑦  Rear window wiper (▷ page 104)

Display panel ③ shows the selected menu or submenu and display messages.

Menu overview

The **Settings** menu is only displayed when the vehicle is stationary. You can think of the order of the menus and functions as a circle. Press  on the instrument cluster to scroll through the menus.

If you scroll forward in the **Settings** menu using , the setting from the previous submenu or function is adopted.

If you press  in a submenu, the submenu or function is exited without adopting the setting. The display then shows the start screen of the **Settings** menu.

Operation information can be found under "Operating the on-board computer" (▷ page 171).

Depending on the vehicle equipment, you can call up the following menus, displays or functions:

- trip odometer and odometer display (▷ page 172)
- trip computer display (▷ page 172)
- current range display (▷ page 173)
- current fuel consumption display (▷ page 173)
- digital speedometer (▷ page 173)
- coolant temperature gage (▷ page 173)
- display messages in the message memory (▷ page 189)

The following menus, displays and functions are only displayed when the vehicle is stationary:

- next service due date display (▷ page 258)
- tire pressure monitor restart (▷ page 284)
- **Settings** menu for setting or activating/deactivating driving and driver assistance

systems as well as display options (▷ page 174)

Distance menu





Odometer

If the display shows the speed in the header, the display beside trip odometer ① also shows the outside temperature.

You can switch the permanent display in the header (▷ page 175).

Use the buttons in the instrument cluster.

► **To display:** press and hold  until the display shows trip odometer ① and odometer ②.

► **To reset:** press and hold  until the trip odometer is reset to 0.0.

You can set the unit of measurement for the trip odometer in the **Distance Unit:** submenu (▷ page 175).

Trip computer menu



Trip computer

- ① Distance
- ② Length of journey
- ③ Average fuel consumption
- ④ Average speed

Use the buttons in the instrument cluster.

- ▶ **To display:** press \ominus to select the trip computer display.

The values displayed relate to those measured since the trip computer was last reset.

- ▶ **To reset values:** press and hold $\text{\textcircled{R}}$ until all values are reset.

The trip computer is automatically reset if the value exceeds 9,999 hours or 99,999 miles.

You can set the unit of measurement for consumption and distance in the **Distance Unit:** submenu (▷ page 175).

Range menu



Use the buttons in the instrument cluster.

- ▶ Press \ominus to select the **Range** display. The approximate range that can be covered is calculated according to your current driving style and the amount of fuel in the tank. If there is only a small amount of fuel left in the fuel tank, the display shows a vehicle being refueled $\text{\textcircled{R}}$ instead of the approximate range.

You can set the unit of measurement for distance in the **Distance Unit:** submenu (▷ page 175).

Current fuel consumption menu



- ① Recuperation display
- ② Range

Use the buttons in the instrument cluster.

- ▶ Press \ominus to select the fuel consumption bar display.

Recuperation display ① shows whether, and, if so, how much kinetic energy is being transformed into electric current whilst the vehicle is coasting. The recuperated energy is then stored in the starter battery. Recuperation display ① is dependent on the engine installed and is therefore not available in all vehicles.

You can set the unit of measurement for consumption in the **Distance Unit:** submenu (▷ page 175).

Digital speedometer menu

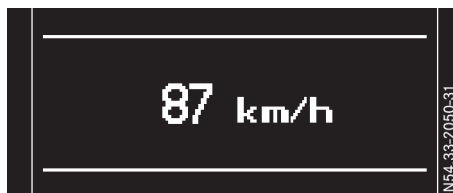

Use the buttons in the instrument cluster.

- ▶ Press \ominus to select the speed display.

You can set the unit for the digital speedometer in the **Distance Unit:** submenu (▷ page 175).

Coolant temperature menu

WARNING

Opening the hood when the engine is overheated or when there is a fire in the engine compartment could expose you to hot gases or other service products. There is a risk of injury.

Let an overheated engine cool down before opening the hood. If there is a fire in the engine compartment, keep the hood closed and contact the fire department.

Use the buttons in the instrument cluster.

- ▶ Press \ominus to select the $\text{\textcircled{R}}$ coolant temperature bar display.

Under normal operating conditions and with the specified coolant level, the gauge may rise to 248 °F (120 °C).

Settings menu

Introduction

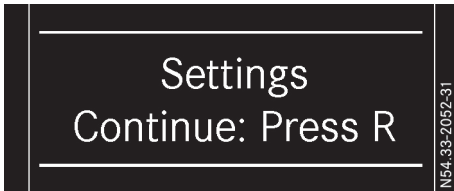

Settings menu start screen

The vehicle must be stationary. Use the buttons in the instrument cluster.

- ▶ **To display:** press \ominus to select the **Settings** menu.

The **Settings** menu is only displayed when the vehicle is stationary. You can think of the order of the submenus and functions as a circle. Press \odot on the instrument cluster to scroll through the menu, starting with its start screen and select its submenus or functions successively. If you scroll forward using \odot , the setting from the previous submenu or function is adopted. If you press \ominus in a submenu, the submenu or function is exited without adopting the setting. The display then shows the start screen of the **Settings** menu.

Depending on the vehicle's equipment, you have the following options in the **Settings** menu:

- Setting the language for the display messages and displays (▷ page 174)
- Deactivating and activating ESP® (▷ page 174)
- Setting the sensitivity of the rain sensor (▷ page 175)
- Activating and deactivating ATTENTION ASSIST (▷ page 175)
- Selecting the permanent display in the header of the display (▷ page 175)
- Setting the unit for distance, consumption and speed displays (▷ page 175)
- Setting the time and date (▷ page 176)
- ▶ **To reset settings to the factory settings:** turn the SmartKey to position **1** in the ignition lock and press and hold \odot in the **Settings** menu for at least five seconds.

For safety reasons, not all functions are reset.

Setting the display language

The vehicle must be stationary. Use the buttons in the instrument cluster.

- ▶ Press \ominus to select the **Settings** menu.
- ▶ Press \odot to select the **Language** submenu. The display shows the current language selection.
- ▶ Press \oplus or \ominus to set the language for all display messages.
- ▶ Press \odot to confirm. The next submenu is shown in the display.

Deactivating/activating ESP®

This menu is only available on vehicles without the ESP OFF button on the center console.

Please observe the important safety notes under "ESP® (Electronic Stability Program)" (▷ page 66).

WARNING

If you deactivate ESP®, ESP® no longer stabilizes the vehicle. There is an increased risk of skidding and an accident.

Only deactivate ESP® in the situations described in the following.

It may be best to deactivate ESP® in the following situations:

- when using snow chains
- in deep snow
- on sand or gravel

Further information can be found under "ESP® (Electronic Stability Program)" (▷ page 66).

The vehicle must be stationary and the engine must be running. Use the buttons in the instrument cluster.

- ▶ Press \ominus to select the **Settings** menu.
- ▶ Press \odot to select the **ESP** submenu. The display shows the current status.

If the display shows the **Oper. Only Poss. With Engine On** message, confirm the message with \odot and start the engine. The display then shows the **ESP** submenu and the ESP® status.

If the **ESP Inoperative** message is shown in the display, ESP is not available due to a malfunction and is deactivated. If you confirm the

message with **(R)**, the display shows the next submenu.

- ▶ Press **(+)** or **(-)** to activate or deactivate ESP.
- ▶ Press **(R)** to confirm.

The next submenu is shown in the display.

If the  warning lamp in the instrument cluster lights up when the vehicle is ready to drive, ESP® is deactivated.

Observe the information on warning lamps (▷ page 222) and display messages (▷ page 194).

Setting the sensitivity of the rain sensor

The vehicle must be stationary. Use the buttons in the instrument cluster.

- ▶ Press **(⊖)** to select the **Settings** menu.
- ▶ Press **(R)** to select the **Rain Sensor** submenu.

The display shows the current sensitivity setting.
- ▶ Press **(+)** or **(-)** to select the **Low**, **Standard** or **Sensitive** setting. This setting controls the rain sensor's sensitivity to precipitation. The windshield wiper will then wipe more or less frequently at the same precipitation intensity.
- ▶ Press **(R)** to confirm.

The next submenu is shown in the display.

You can find further information under "Windshield wiper" (▷ page 104).

Activating/deactivating ATTENTION ASSIST

The vehicle must be stationary. Use the buttons in the instrument cluster.

- ▶ Press **(⊖)** to select the **Settings** menu.
- ▶ Press **(R)** to select the **Attention Assist** submenu.

The display shows the current status.

If the **Attention Assist Inoperative** message is shown in the display, ATTENTION ASSIST is not available due to a malfunction and is deactivated. If you confirm the message with **(R)**, the display shows the next submenu.
- ▶ Press **(+)** or **(-)** to activate or deactivate ATTENTION ASSIST.
- ▶ Press **(R)** to confirm.

The next submenu is shown in the display.

Further information can be found under "ATTENTION ASSIST" (▷ page 150).

Selecting the permanent display function

With the **Permanent Display:** function, you can switch the display in the header between outside temperature and speed.

If the display shows the speed in the header, the outside temperature is shown with the odometers (▷ page 172).

The additional speedometer unit in the header is always inverse to the speedometer unit.

The vehicle must be stationary. Use the buttons in the instrument cluster.

- ▶ Using **(⊖)** select the **Settings** menu.
- ▶ Using **(R)** select the **Permanent Display:** submenu.

The display indicates the selected setting of **Outside Temp.** or **Speedometer.**
- ▶ Change the setting by pressing **(+)** or **(-)**.
- ▶ Press **(R)** to confirm.

The next submenu is shown in the display.

Selecting the unit for the distance

In the **Distance Unit:** submenu, you can select whether the display shows certain information in kilometers or miles.

The vehicle must be stationary. Use the buttons in the instrument cluster.

- ▶ Press **(⊖)** to select the **Settings** menu.
- ▶ Press **(R)** to select the **Distance Unit:** submenu.

The display indicates the selected setting of **km** or **Miles.**
- ▶ Change the setting by pressing **(+)** or **(-)**.
- ▶ Press **(R)** to confirm.

The display shows the next submenu or the **Settings** menu again.

The selected distance units are used for the displays:

- Digital speedometer
- Odometer and trip odometer
- Trip computer
- Range
- Current consumption
- Cruise control
- Service intervals

Setting the time and date

The vehicle must be stationary. Use the buttons in the instrument cluster.

- ▶ Press **(M)** to select the **Settings** menu.
 - ▶ Press **(R)** to select the time and date display.
 - ▶ Press **(+)** or **(-)** to set the hours and press **(R)** to confirm.
 - ▶ Press **(+)** or **(-)** to set the minutes and press **(R)** to confirm.
 - ▶ Press **(+)** or **(-)** to set the day and press **(R)** to confirm.
 - ▶ Press **(+)** or **(-)** to set the month and press **(R)** to confirm.
 - ▶ Press **(+)** or **(-)** to set the year and press **(R)** to confirm.
- The display shows the **Settings** menu again.

steering wheel buttons in right control panel **(2)** you can control the functions of the audio system and switch on voice-operated control of the navigation system (see the separate operating instructions).

Steering wheel buttons

Left control panel on the steering wheel



- Calls up the menu bar in the display
- Selects a menu



Press briefly:

- Scrolls through lists
- Selects a submenu or function
- In the **Audio** menu: opens the track or station list and selects a station or an audio track
- In the **Tel** (Telephone) menu: switches to the phone book and selects a name or a telephone number



Press and hold:

- Quickly scrolls through all lists
- In the **Audio** menu: selects a station or an audio track using rapid scrolling.
- In the **Tel** (telephone) menu: starts rapid scrolling if the phone book is open



- Confirms the display message
- In all menus: confirms the selected entry in the list or the display
- In the **Audio** menu: stops the station search
- In the **Tel** (telephone) menu: switches to the phone book and starts dialing the selected number

On-board computer (vehicles with steering wheel buttons)

Operating the on-board computer

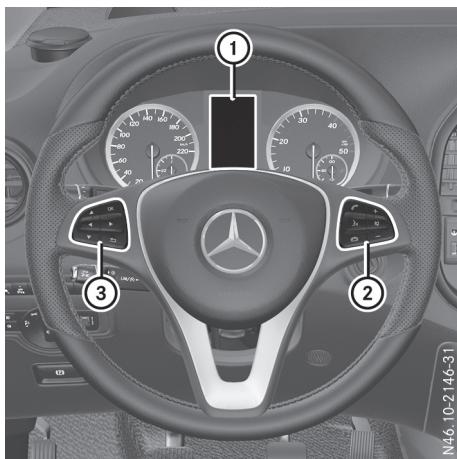

Overview







- ① Display
- ② Right control panel
- ③ Left control panel

- ▶ **To activate the on-board computer:** turn the SmartKey to position **1** in the ignition lock.

You can control the displays and the settings in the on-board computer using the steering wheel buttons in left control panels **(3)**. Using the

	Press briefly:
	<ul style="list-style-type: none"> • Back • In the Audio menu: exits the track or station list • Hides display messages • Exits the telephone book/redial memory • Vehicles with a navigation system: switches off voice-operated control of the navigation system (see the manufacturer's operating instructions)
	Press and hold:
	<ul style="list-style-type: none"> • Calls up the standard display in the Trip menu

Right control panel on the steering wheel

	<ul style="list-style-type: none"> • Makes or accepts a call • Switches to the redial memory
	<ul style="list-style-type: none"> • Rejects or ends a call • Exits the telephone book/redial memory
	<ul style="list-style-type: none"> • Adjusts the volume
	<ul style="list-style-type: none"> • Vehicles with a navigation system: switches on voice-operated control of the navigation system (see the manufacturer's operating instructions)
	<ul style="list-style-type: none"> • Mute

i The audio devices, telephone and voice-operated control using the steering wheel buttons in the right control panel only function with a Mercedes-Benz audio or navigation system. If you are using an audio or navigation system from another manufacturer, the described functions may be restricted or not available at all.

Display

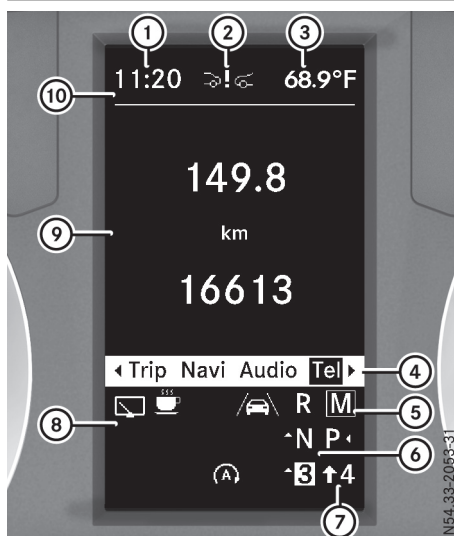





Instrument cluster display

- ① Clock (▷ page 187)
- ②  COLLISION PREVENTION ASSIST distance warning function (▷ page 144)
- ③ **P** Active Parking Assist (▷ page 154)
- ④ Permanent display: outside temperature or speed (▷ page 186)
120 km/h! (only for certain countries) maximum permissible speed exceeded
- ④ Menu bar
 Outside temperature (only if header ⑩ displays the additional speedometer)
- ⑤ Drive program (▷ page 128)
- ⑥ Transmission position (▷ page 127)
- ⑦ Gearshift recommendation (▷ page 131)
- ⑧ Status area
- ⑨ Display panel for display messages, menus and menu bar
- ⑩ Header

► **To call up menu bar ④ in the display panel:** press the ◀ or ▶ steering wheel button.
 The menu bar is faded out after a few seconds.

Display panel ⑨ shows the selected menu or submenu and display messages.

In status area ⑧, the display can show the status of the following driving systems:

-  ATTENTION ASSIST (▷ page 150)
-  Lane Keeping Assist (▷ page 148)
-  Cruise control (▷ page 142)
-  Rear window wiper (▷ page 104)
-  ECO start/stop function (▷ page 123)

Menu overview

You can think of the order of the menus as a circle. Use the ◀ or ▶ steering wheel buttons to show the menu bar and scroll through the menus. Use the ▼ or ▲ steering wheel buttons to scroll through their submenus and functions.

Operation information can be found under "Operating the on-board computer" (▷ page 176).

Depending on the vehicle equipment, you can call up the following menus:

- **Trip** menu (▷ page 178)
- **Navi** menu (navigation instructions) (▷ page 180)
- **Audio** menu (▷ page 181)
- **Tel** (telephone) menu (▷ page 182)
- **Assist.** (assistance) menu (▷ page 183)
- **Service** menu (▷ page 185)
- **Settings** menu (▷ page 186)

Trip menu

Standard display

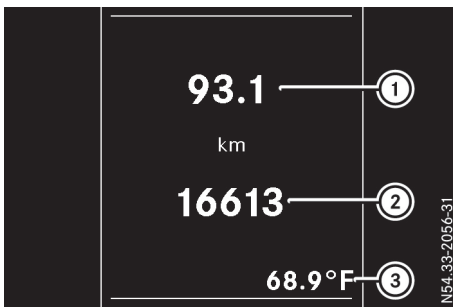

Odometer

- ▶ Press and hold the ◀ steering wheel button until the **Trip** menu with trip odometer ① and odometer ② appears.

If the display shows the speed in the header, the outside temperature is additionally displayed on the lower edge of display panel ③.

You can switch the permanent display in the header (▷ page 186).

Displaying the range and current fuel consumption

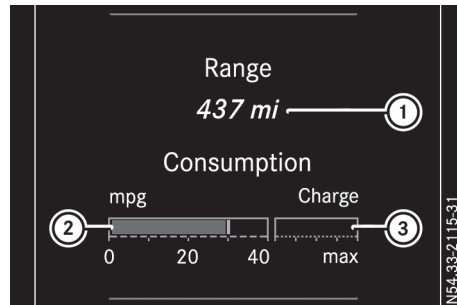

Using the steering wheel buttons

- ▶ Press ◀ or ▶ to select the **Trip** menu.
- ▶ Press ▼ or ▲ to select range ① and consumption ②.

Approximate range ① is calculated on the basis of your current driving style and the amount of fuel in the tank. If there is only a small amount of fuel left in the fuel tank, the display shows a vehicle being refueled  instead of the approximate range.

Recuperation display ③ shows whether, and, if so, how much kinetic energy is being transformed into electric current whilst the vehicle is coasting. The recuperated energy is then stored in the starter battery. Recuperation display ③ is dependent on the engine installed and is therefore not available in all vehicles.

Trip computer "From Start" or "From Reset"



- ① Distance
- ② Length of journey
- ③ Average fuel consumption
- ④ Average speed

Using the steering wheel buttons

- ▶ Press or to select the **Trip** menu.
- ▶ Press or to select the **From Start** or **From Reset** submenu.

The values in the **From Start** submenu are calculated from the start of a journey whilst the values in the **From Reset** submenu are calculated from the last time the submenu was reset (▷ page 179).

The **From Start** trip computer function is automatically reset in the following situations:

- the ignition has been switched off for more than four hours.
- 999 hours have been exceeded.
- 9,999 miles have been exceeded.

The **From Reset** trip computer is automatically reset if the value exceeds 9,999 hours or 99,999 miles.

Digital speedometer

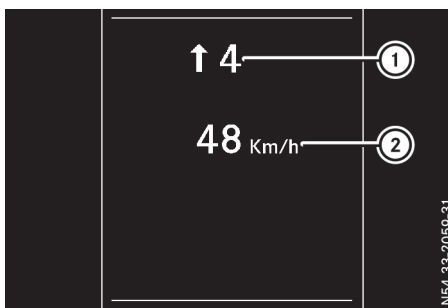

- ① Gearshift recommendation
Automatic transmission (▷ page 131)
- ② Digital speedometer

Use the steering wheel buttons.

- ▶ Press or to select the **Trip** menu.
- ▶ Select the digital speedometer by pressing or .

Resetting values

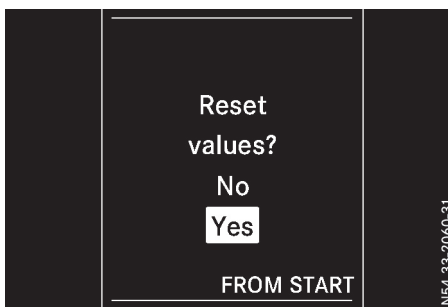

Resetting values (example: "From start" trip computer)

Using the steering wheel buttons

- ▶ Press or to select the **Trip** menu.
- ▶ Press or to select the function you would like to reset.
- ▶ Press to confirm.
- ▶ Press to select **Yes** and press to confirm.

You can reset the values of the following functions:



- Trip odometer
- "From start" trip computer
- "From reset" trip computer

Navigation menu

Displaying navigation instructions

In the **Navi** menu, the display shows the navigation instructions from the audio system and or the navigation system. Further information on the audio and/or navigation system can be found in the separate operating instructions.

Using the steering wheel buttons

- ▶ Activate the audio and/or navigation system (see separate operating instructions).
- ▶ Press  or  to select the **Navi** menu.
- ▶ Press  to confirm.

Route guidance not active

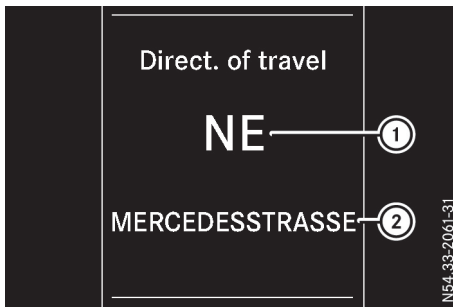

- ① Direction of travel
- ② Current street

Route guidance active

No change of direction announced

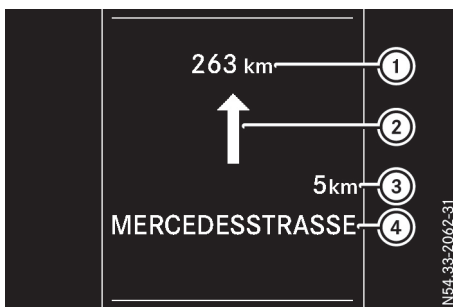

- ① Distance to the next destination
- ② Change-of-direction symbol
- ③ Distance to the next change of direction
- ④ Current street

Change of direction announced with a lane recommendation

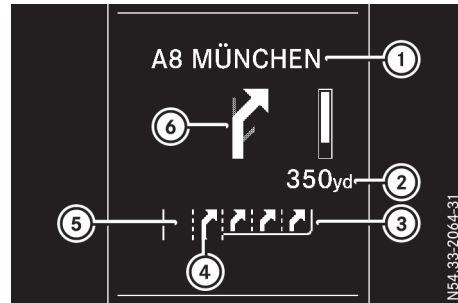

- ① Road to which the change of direction leads
- ② Distance to the change of direction and distance graphic
- ③ Recommended lane and new lane during a change of direction
- ④ Possible lane
- ⑤ Lane not recommended
- ⑥ Change-of-direction symbol

On multilane roads, new lane recommendations can be displayed for the next change of direction if the digital map contains the corresponding data. During the change of direction, new lanes may be added.

Lane not recommended (⑤): you will not be able to complete the next change of direction if you stay in this lane.

Possible lane (④): you will be able to complete the next change of direction in this lane only.

Recommended lane (③): in this lane you will be able to complete the next change of direction and the one after that.

Change of direction announced without lane recommendation

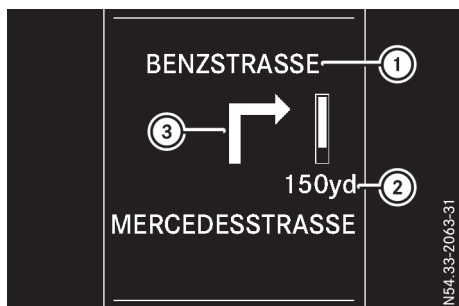

- ① Road to which the change of direction leads
- ② Distance to the change of direction and distance graphic
- ③ Change-of-direction symbol

If a change of direction is required, a dynamic bar is shown as a distance graphic above the distance to the change of direction ②. The bar shortens towards the top of the display as you approach the point of the announced change of direction. The change of direction starts once the distance graphic no longer shows a bar.

Other navigation system status indicators

- **New Route...** or **Calculating Route**
A new route is calculated.
- **Off Map** or a compass needle pointing in the direction of the destination
The vehicle position is outside the area of the digital map (off-map position) or the road is not recognized, e.g. unpaved roads (off-road).
- **No Route**
No route could be calculated to the selected destination.
- 
You have reached the destination or an intermediate destination.

Audio menu



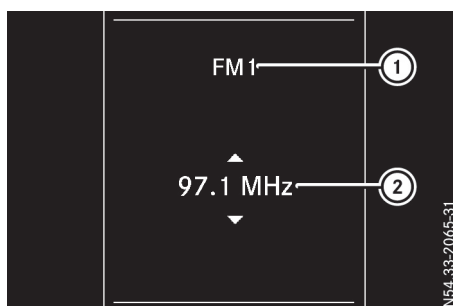





Selecting a radio station



- ① Waveband with station preset
- ② Station

Station ② is displayed with the station frequency or station name. The station preset is only displayed along with waveband ① if the station has been stored.

Using the steering wheel buttons

- ▶ Switch on the audio system and select the radio function (see separate operating instructions).
 - ▶ Press  or  to select the **Audio** menu.
The display shows currently selected station ②.
 - ▶ **To select a stored station:** press  or  briefly.
 - ▶ **To select a station from the station list:** press and hold  or .
- If a station list is not received:
- ▶ **To select a station using the station search:** press and hold  or .

Operating the audio medium

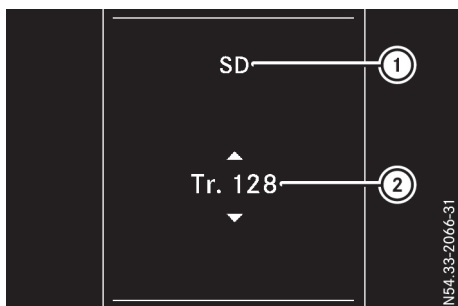

Track information (example: SD memory card)

- ① Audio source
- ② Current track

Depending on the audio system, you can play audio files from different audio sources, such as a memory card (SD), a USB storage medium or a Bluetooth® audio device.

Using the steering wheel buttons

- ▶ Switch on the audio system and select an audio source (see separate operating instructions).
- ▶ Press or to select the **Audio** menu.
- ▶ **To open the track list:** press or briefly.
- ▶ **To select next/previous track from the track list:** briefly press or .
- ▶ **To select a track from the track list using rapid scrolling:** press and hold or until the desired track is reached. If you hold down or , the system runs through the list more quickly. Not all audio sources support this function.

If the corresponding track information is stored on the audio media, the display may show the following:

- track number
- artist and/or track name
- folder name

The track information does not appear in audio AUX mode (**A**uxiliary audio mode: external audio source connected).

Telephone menu

Introduction

WARNING

If you operate information systems and communication equipment integrated in the vehicle while driving, you will be distracted from traffic conditions. You could also lose control of the vehicle. There is a risk of an accident.

Only operate the equipment when the traffic situation permits. If you are not sure that this is possible, park the vehicle paying attention to traffic conditions and operate the equipment when the vehicle is stationary.

When using the phone, you must observe the legal requirements for the country in which you are currently driving.

- ▶ Switch on the audio system (see the separate operating instructions).
- ▶ Switch on the mobile phone (see the manufacturer's separate operating instructions).
- ▶ Establish a Bluetooth® connection between the mobile phone and the audio system (see the separate operating instructions).

Using the steering wheel buttons

- ▶ Press or to select the **Te**l menu.

The display shows one of the following messages:

- The name of the network provider or **Phone READY**: the mobile phone has found a network and is ready to receive.
- **No Service**: there is no network available or the mobile phone is searching for a network.
- **Bluetooth Ready**: you have not yet established a Bluetooth® connection between the mobile phone and the audio system.

You can obtain further information about suitable mobile phones and connecting mobile phones via Bluetooth®:

- at your Mercedes-Benz Commercial Van Center
- on the Internet at <http://www.mercedes-benz.com/connect>

Accepting a call



- ▶ Press the  button to answer a call.







If someone calls you when you are in the **Te1** menu, a corresponding display message appears in the multifunction display.

Rejecting or ending a call

- ▶ Press the  steering wheel button.



Dialing a number from the phone book

Using the steering wheel buttons

- ▶ Press  or  to select the **Te1** menu.
- ▶ Press ,  or **OK** to switch to the phone book.
- ▶ Press  or  to select names successively.

If you press and hold the button for longer than one second, the names in the phone book are shown rapidly one after another.

or

- ▶ Press and hold  or  for longer than five seconds.

Rapid scrolling – the name that starts with the next letter or the previous letter in the alphabet is displayed. Rapid scrolling stops when you release the button or reach the end of the list.

- ▶ **If only one telephone number is stored for a name:** press  or **OK** to start dialing.

or

- ▶ **If there is more than one number for a particular name:** press the  or **OK** button to display the numbers.

- ▶ Press ,  to select a telephone number.







- ▶ Press  or **OK** to start dialing.

or



- ▶ **To exit the phone book:** press  or .

Redialing

The on-board computer saves the last names or numbers dialed in the redial memory. Using the steering wheel buttons

- ▶ Press  or  to select the **Te1** menu.
- ▶ Press the  button to switch to the redial memory.
- ▶ Press  or  to select names or telephone numbers.
- ▶ Press the  or **OK** button to start dialing.

or

- ▶ **To exit the redial memory:** press the  or  button.

Assistance menu

Introduction

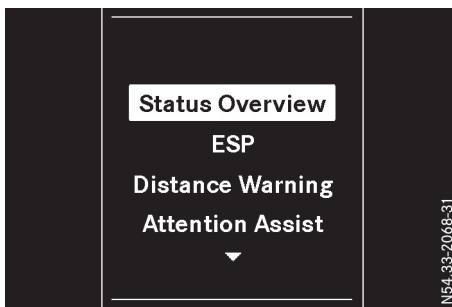

Depending on the vehicle's equipment, you have the following options in the **Assist.** menu:

- Displaying the status overview (▷ page 184)
- Deactivating or activating ESP® (▷ page 184)
- Activating or deactivating the COLLISION PREVENTION ASSIST distance warning function (▷ page 185)
- Setting the ATTENTION ASSIST sensitivity (▷ page 185)
- Activating or deactivating Blind Spot Assist (▷ page 185)
- Setting the sensitivity of Lane Keeping Assist (▷ page 185)

Status overview

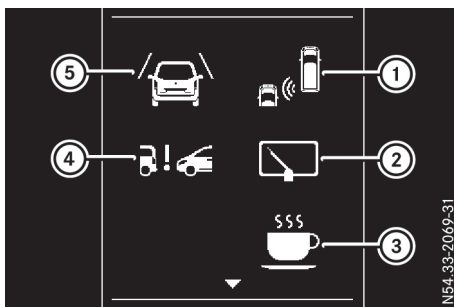

- ① Blind Spot Assist switched on and activated (▷ page 185)
- ② Rear window wiper switched on (▷ page 104)
- ③ ATTENTION ASSIST activated (▷ page 185)
- ④ COLLISION PREVENTION ASSIST distance warning function activated (▷ page 185)
- ⑤ Lane Keeping Assist activated and ready for use (▷ page 185)

- ▶ Press or to select the **Assist.** menu.
- ▶ Press or to select **Status Overview.**
- ▶ Press the button.

The **Status Overview** only shows the symbols of the driving systems or driving safety systems that are activated. The Blind Spot Assist and Lane Keeping Assist symbols may vary depending of the system status:

- If Blind Spot Assist symbol ① does not show any radar waves between the two vehicles, Blind Spot Assist is switched on but not ready for use.
Further information can be found under "Blind Spot Assist" (▷ page 146).
- If Lane Keeping Assist symbol ⑤ shows dashed lane boundary lines, Lane Keeping Assist is switched on but not ready for use.
Further information can be found under "Lane Keeping Assist" (▷ page 148).

You can also have the ATTENTION ASSIST assessment or the attention level displayed in the **Status Overview**.



- ▶ **To display the attention level:** press and to switch between the status overview and the ATTENTION ASSIST assessment. The ATTENTION ASSIST assessment shows the length of the journey since the last break as well as the attention level detected (▷ page 150).

Deactivating/activating ESP®

This menu is only available on vehicles without the button on the center console.

Please observe the important safety notes under "ESP® (Electronic Stability Program)" (▷ page 66).

WARNING

If you deactivate ESP®, ESP® no longer stabilizes the vehicle. There is an increased risk of skidding and an accident.

Only deactivate ESP® in the situations described in the following.

It may be best to deactivate ESP® in the following situations:

- when using snow chains
- in deep snow
- on sand or gravel

Further information can be found under "ESP® (Electronic Stability Program)" (▷ page 66).

- ▶ Start the engine.

Using the steering wheel buttons

- ▶ Press or to select the **Assist.** menu.
- ▶ Press or to select **ESP.**





- ▶ Press **OK** to confirm.
The current status is shown.
- ▶ **To activate/deactivate:** press **OK** again.
If the  warning lamp in the instrument cluster lights up when the vehicle is ready to drive, ESP® is deactivated.

If the  warning lamp lights up continuously, ESP® is not available due to a malfunction.



Observe the information on warning lamps (▷ page 222) and display messages (▷ page 208).

Activating/deactivating the distance warning function

Using the steering wheel buttons

- ▶ Press  or  to select the **Assist.** menu.
- ▶ Press  or  to select **Distance Warning.**
- ▶ Press **OK** to confirm.
The current status is shown.
- ▶ **To activate/deactivate:** press the **OK** button again.







If the distance warning function of COLLISION PREVENTION ASSIST is activated, the display shows the  symbol in the header.

At speeds up to approx 20 mph (30 km/h), the display in vehicles with Active Parking Assist first shows the  status indicator. Only up to a speed of about 20 mph (30 km/h) does the display show the  symbol instead of the .

Further information can be found under "COLLISION PREVENTION ASSIST" (▷ page 144).

Setting ATTENTION ASSIST

Using the steering wheel buttons





- ▶ Press  or  to select the **Assist.** menu.
- ▶ Press  or  to select **Attention Assist.**
- ▶ Press **OK** to confirm.
The current setting is displayed.
- ▶ **To change the setting:** press **OK** again.
- ▶ Press  or  to set **Deactivated**, **Standard** or **Sensitive.**
- ▶ Press **OK** to confirm the choice.
If ATTENTION ASSIST is activated, the  symbol is shown in the status area of the dis-

play. The selection **Standard** or **Sensitive** sets the sensitivity with which the system determines the attention level.

Further information can be found under "ATTENTION ASSIST" (▷ page 150).

Activating/deactivating Blind Spot Assist





Using the steering wheel buttons

- ▶ Press  or  to select the **Assist.** menu.
- ▶ Press  or  to select **Blind Spot Assist.**
- ▶ Press **OK** to confirm.
The current status is shown.
- ▶ **To activate/deactivate:** press the **OK** button again.

Further information can be found under "Blind Spot Assist" (▷ page 146).

Setting Lane Keeping Assist

Using the steering wheel buttons

- ▶ Press  or  to select the **Assist.** menu.
- ▶ Press  or  to select **Lane Keeping Assist.**
- ▶ Press **OK** to confirm.
The current selection **Standard** or **Adaptive** is displayed.
- ▶ **To change the setting:** press **OK** again.

Further information can be found under "Lane Keeping Assist" (▷ page 148).

Service menu

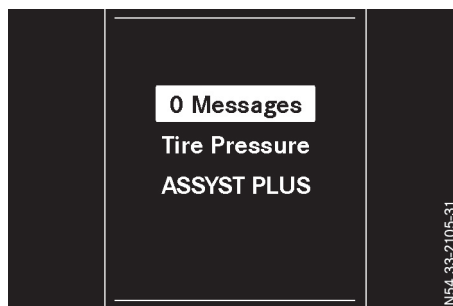

Depending on the vehicle's equipment, you have the following options in the **Service** menu:

- Calling up display messages in the message memory (▷ page 203)
- Restarting the tire pressure loss warning system or checking the tire pressure electronically (▷ page 284)
- Calling up the service due date (ASSYST PLUS) (▷ page 258)

Settings menu

Introduction

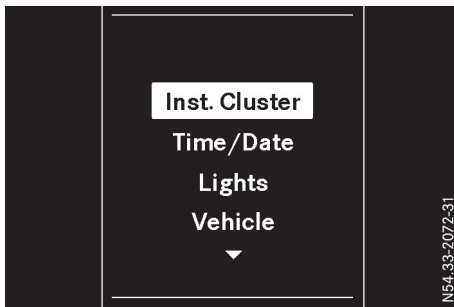

Depending on the vehicle's equipment, you have the following options in the **Settings** menu:

- changing the display options in the **Inst. Cluster** submenu (▷ page 186)
- changing the time and date in the **Time/Date** submenu (▷ page 187)
- changing the exterior and interior lighting settings in the **Lights** submenu (▷ page 187)
- activating/deactivating or adjusting vehicle functions in the **Vehicle** submenu (▷ page 188)
- resetting the settings to **Factory Setting** (▷ page 188)

Instrument cluster submenu

Selecting the unit for the distance

With the **Display Unit Speed-/Odometer:** function, you can select whether the display shows certain information in kilometers or miles.

Use the steering wheel buttons.

- ▶ Press or to select the **Settings** menu.
- ▶ Press or to select **Inst. Cluster**.
- ▶ Press to confirm.
- ▶ Press or to select the **Display Unit Speed-/Odometer:** function. The display indicates the selected **km** or **Miles** setting.
- ▶ Press to change the setting.

The unit for the distance will be selected for:

- Digital speedometer in the **Trip** menu
- Odometer and trip odometer
- Trip computer
- Current consumption and range
- Navigation instructions in the **Navi** menu
- Cruise control
- Service interval display

Setting the display language

Using the steering wheel buttons

- ▶ Press or to select the **Settings** menu.
- ▶ Press or to select **Inst. Cluster**.
- ▶ Press to confirm.
- ▶ Press or to select **Language:**. The display shows the current language selection for all display messages.
- ▶ Press to change the setting.
- ▶ Press or to select the desired language.
- ▶ Press the button to save the selection.

Selecting the permanent display function

Using the **Permanent Display:** function, you can switch the display in the header between outside temperature and speed.

If the display shows the speed in the header, the display shows the outside temperature with the odometers (▷ page 178). The additional speedometer unit in the header is always inverse to the speedometer unit.

Using the steering wheel buttons

- ▶ Press or to select the **Settings** menu.
- ▶ Press or to select **Inst. Cluster**.
- ▶ Press to confirm.
- ▶ Press or to select **Permanent Display..**
- ▶ Press to confirm.
The display shows the current selection of **Outside Temp.** or **Speedom..**
- ▶ Press to change the setting.

Clock/Date submenu

Setting the time

Using the steering wheel buttons

- ▶ Press or to select the **Settings** menu.
- ▶ Press or to select **Time/Date**.
- ▶ Press to confirm.
- ▶ Press or to select the **Time:** function.
The display shows the current time.
- ▶ **To set the time:** press again.
- ▶ Press or to switch between hours and minutes.
- ▶ Press or to set the hours or minutes.
- ▶ Then press to confirm.
The display shows the updated time.

Setting the date

Using the steering wheel buttons

- ▶ Press or to select the **Settings** menu.
- ▶ Press or to select **Time/Date**.
- ▶ Press to confirm.
- ▶ Press or to select the **Date:** function.
The display shows the current date.
- ▶ **To set the date:** press again.
- ▶ Press or to switch between day, month and year.
- ▶ Press or to set the day, month or year.
- ▶ Then press to confirm.
The display shows the updated date.

Lights submenu

Activating/deactivating the surround lighting and exterior lighting delayed switch-off

If you activate the **Locator Lighting** function and the light switch is turned to the **AUTO** position, the following functions are activated when it is dark:

- **Surround lighting:** the exterior lighting remains on for 40 seconds after the doors are unlocked. When you start the engine, the surround lighting is deactivated and the automatic headlamp feature is activated (▷ page 95).
- **Exterior lighting delayed switch-off:** the exterior lighting remains on for 60 seconds after the engine is switched off. If you close all the doors and the tailgate/rear doors, the exterior lighting switches off after 15 seconds.

Using the steering wheel buttons

- ▶ Press or to select the **Settings** menu.
- ▶ Press or to select **Lights**.
- ▶ Press to confirm.
- ▶ Press or to select the **Locator Lighting** function.
The current status is shown.
- ▶ **To activate/deactivate:** press again.
If you change the setting, conversion does not take place until the next time the vehicle is stationary.

Temporarily deactivating the exterior lighting delayed switch-off:

- ▶ Before leaving the vehicle, turn the key to position **0** in the ignition lock.
- ▶ Turn the key to position **2** in the ignition lock.
The exterior lighting delayed switch-off is deactivated until the next time the engine is started.

With surround lighting and exterior lighting delayed switch-off, the following light up depending on the vehicle's equipment:

- Parking lamps
- Fog lamps
- Low-beam headlamps
- Daytime running lamps

Activating/deactivating interior lighting delayed switch-off

If you activate the **Interior Lighting Delay** function, the interior lighting remains lit for a further 20 seconds after the key is removed.

Using the steering wheel buttons

- ▶ Press or to select the **Settings** menu.
- ▶ Press or to select **Lights**.
- ▶ Press to confirm.
- ▶ Press or to select the **Interior Lighting Delay** function.
The current status is shown.
- ▶ **To activate/deactivate:** press again.

Vehicle submenu

Setting the sensitivity of the rain sensor

Using the steering wheel buttons

- ▶ Press or to select the **Settings** menu.
- ▶ Press or to select **Vehicle**.
- ▶ Press to confirm.
- ▶ Press or to select the **Rain Sensor Sensitivity** function.
The display shows the current setting.
- ▶ Press to change the setting.
- ▶ Press or to select the **High**, **Standard** or **Low** setting. This setting controls the rain sensor's sensitivity to precipitation.
The windshield wiper then wipes more or less frequently at the same precipitation intensity.
- ▶ Press the button to store the entry.

You can find further information under "Windshield wiper" (▷ page 104).

Switching the automatic locking feature on/off

Using the steering wheel buttons

- ▶ Press or to select the **Settings** menu.
- ▶ Press or to select **Vehicle**.

- ▶ Press to confirm.
- ▶ Press or to select the **Automatic Door Lock** function.
The current status is shown.
- ▶ **To activate/deactivate:** press again.

If you activate the **Automatic Door Lock** function, your vehicle will lock automatically from a speed of approximately 15 km/h.

You can find further information under "Automatic door lock" (▷ page 74).

Activating/deactivating the acoustic locking confirmation

Using the steering wheel buttons

- ▶ Press or to select the **Settings** menu.
- ▶ Press or to select **Vehicle**.
- ▶ Press to confirm.
- ▶ Press or to select **Acoustic Lock Feedback**.
The current status is shown.
- ▶ **To activate/deactivate:** press again.

If you activate the **Acoustic Lock Feedback** function, an acoustic tone sounds when the vehicle is locked.

Restoring the factory settings

Using the steering wheel buttons

- ▶ Press or to select the **Settings** menu.
- ▶ Press or to select **Factory Setting**.
- ▶ Press to confirm.
The **Reset All Settings?** function is displayed.
- ▶ Press or to select **No** or **Yes**.
- ▶ Press to confirm the choice.
If you select **Yes**, the display shows a confirmation message.

Display messages (vehicles without steering wheel buttons)

Introduction

Important safety notes

WARNING

If the instrument cluster has failed or malfunctioned, you may not recognize function restrictions in systems relevant to safety. The operating safety of your vehicle may be impaired. There is a risk of an accident.

Drive on carefully. Have the vehicle checked at a qualified specialist workshop immediately.

The on-board computer only shows messages or warnings from certain systems in the instrument cluster display. You should therefore make sure your vehicle is operating safely at all times. If the operating safety of your vehicle is impaired, stop the vehicle as soon as possible, paying attention to road and traffic conditions. Then consult a qualified specialist workshop.

Display messages with graphic symbols are simplified in the Operator's Manual and may differ from the symbols in the display. A warning tone sounds with certain display messages.

Please respond in accordance with the display messages and follow the additional notes in this Operator's Manual.

You can hide low-priority display messages using the **(R)** button on the instrument cluster. The display messages are then stored in the message memory. Rectify the cause of a display message as soon as possible.

High-priority display messages cannot be hidden. These messages will continue to be shown in the display until their cause has been eliminated.

Message memory

The on-board computer stores certain display messages in the message memory. You can call up the stored display messages. Use the buttons in the instrument cluster.

- ▶ Press **(M)** to select the message memory.
 - If there are display messages, the display shows the number of saved messages.
 - If there are no display messages, the display shows **No Messages**.
- ▶ Press **(R)** to scroll forwards through the display messages.
 - After the last saved display message, the display again shows the message memory start screen with the number of saved messages.
 - Press **(M)** to exit the display messages and jump directly to the message memory start screen.

Safety systems

Display messages

Possible causes/consequences and ► Solutions

ABS, ESP Inoperative



ABS, BAS, hill start assist, and ESP[®] as well as its driving safety systems are unavailable due to a malfunction.

ATTENTION ASSIST is deactivated and other driving systems could be automatically deactivated.

WARNING

The brake system continues to function normally, but without the functions listed above. The wheels could therefore lock if you brake hard, for example.

This causes steerability and braking to be greatly impaired. The braking distance can increase in emergency braking situations.

If ESP[®] is not operational, ESP[®] will not stabilize the vehicle.

There is an increased risk of skidding and accidents.

- Switch the engine off, wait briefly and start the engine again.
- Check if the display message has disappeared and ESP[®] is operational.
- If the display message continues to be displayed:
 - Drive on with care.
 - Visit a qualified specialist workshop immediately.

ABS, ESP Curr. Unavail.



ABS, BAS, hill start assist, and ESP[®] as well as its driving safety systems are temporarily unavailable.

ATTENTION ASSIST is deactivated and other driving systems could be automatically deactivated.

For example, the on-board voltage may be insufficient.

WARNING



The brake system continues to function normally, but without the functions listed above. The wheels could therefore lock if you brake hard, for example.

This causes steerability and braking to be greatly impaired. The braking distance can increase in emergency braking situations.





If ESP[®] is not operational, ESP[®] will not stabilize the vehicle.

There is an increased risk of skidding and accidents.







- Drive on with care and on a suitable stretch of road make slight steering movements at a speed above 12 mph (20 km/h).
- Switch the engine off, wait briefly and start the engine again.
- Check if the display message has disappeared and ESP[®] is operational.
- If the display message continues to be displayed:
 - Drive on with care.
 - Visit a qualified specialist workshop immediately.













Display messages	Possible causes/consequences and ► Solutions
<p>Front Passenger Air-bag Disabled</p> 	<p>The front-passenger air bag is deactivated during the journey even though the front-passenger seat is occupied by an adult or a person with a stature corresponding to that of an adult.</p> <p>If additional forces are applied to the seat or the occupant is not sitting on the seat properly (► page 53), the weight the system detects may be too low.</p> <p> WARNING</p> <p>The front-passenger front air bag will not deploy in the event of an accident.</p> <p>There is an increased risk of injury.</p> <ul style="list-style-type: none"> ► Stop the vehicle immediately, paying attention to road and traffic conditions. ► Secure the vehicle to prevent it from rolling away (► page 133). ► Switch off the ignition. ► The front passenger must get out of the vehicle. ► Make sure that the front-passenger seat is unoccupied, close the front-passenger door and switch on the ignition. ► Observe the PASSENGER AIRBAG OFF indicator lamp in the center console and the display messages and check the following: <p>Seat unoccupied and ignition switched on:</p> <ul style="list-style-type: none"> • The PASSENGER AIRBAG OFF indicator lamp must light up continuously. If the indicator lamp is on, the Occupant Classification System (OCS) has disabled the front-passenger air bag (► page 53). • The display must not show the messages Front Passenger Air-bag Enabled or Front Passenger Airbag Disabled. <ul style="list-style-type: none"> ► Wait for at least one minute until the necessary system checks have been completed. ► Ensure that the display does not show either of the two display messages about the front-passenger front air bag. <p>If these conditions are met, the front-passenger seat can be occupied again.</p> <p>If these conditions are not met, the Occupant Classification System (OCS) is malfunctioning.</p> <ul style="list-style-type: none"> ► Visit a qualified specialist workshop immediately. <p>Further information on the Occupant Classification System (OCS) can be found under "Occupant Classification System (OCS)" (► page 53).</p>







Display messages	Possible causes/consequences and ► Solutions
<p data-bbox="177 252 431 318">Front Passenger Airbag Enabled</p> 	<p data-bbox="431 252 1108 318">The front-passenger front air bag is enabled during the journey even though the front-passenger seat:</p> <ul data-bbox="431 324 1108 444" style="list-style-type: none"> • is occupied by a child in a child restraint system, or a person of small stature or • is not occupied. <p data-bbox="431 449 1108 498">The system may detect objects or forces that are adding to the weight applied to the seat.</p> <p data-bbox="431 503 1108 551">⚠ WARNING</p> <p data-bbox="431 557 1108 611">The front-passenger air bag may deploy unintentionally. There is an increased risk of injury.</p> <ul data-bbox="431 616 1108 1041" style="list-style-type: none"> ► Stop the vehicle immediately, paying attention to road and traffic conditions. ► Secure the vehicle to prevent it from rolling away (► page 133). ► Switch off the ignition. ► Open the front-passenger door. ► Remove the child and the child restraint system from the front-passenger seat. ► Make sure there are no objects applying additional weight to the seat. The system may otherwise detect the additional weight and interpret the vehicle seat occupant's weight as greater than it actually is. ► Make sure that the front-passenger seat is unoccupied, close the front-passenger door and switch on the ignition. ► Observe the PASSENGER AIRBAG OFF indicator lamp in the center console and the display and check the following: <p data-bbox="431 1046 1108 1076">Seat unoccupied and ignition switched on:</p> <ul data-bbox="431 1082 1108 1327" style="list-style-type: none"> • The PASSENGER AIRBAG OFF indicator lamp must light up continuously. If the indicator lamp is on, the Occupant Classification System (OCS) has disabled the front-passenger air bag (► page 53). • The display must not show the messages Front Passenger Airbag Enabled or Front Passenger Airbag Disabled. ► Wait for at least one minute until the necessary system checks have been completed. ► Ensure that the display does not show either of the two display messages about the front-passenger front air bag. <p data-bbox="431 1333 1108 1417">If these conditions are met, the front-passenger seat can be occupied again. Observe the notes on the Occupant Classification System (OCS) (► page 53).</p> <p data-bbox="431 1422 1108 1476">If these conditions are not met, the Occupant Classification System (OCS) is malfunctioning.</p> <ul data-bbox="431 1481 1108 1605" style="list-style-type: none"> ► Install the child restraint system on a suitable rear seat. or ► Seat a person of small stature on a suitable rear seat. ► Visit a qualified specialist workshop immediately.











Display messages	Possible causes/consequences and ► Solutions
	Further information on the Occupant Classification System (OCS) can be found under "Occupant Classification System (OCS)" (► page 53).
 Check Brake Pad Wear	The brake pads/linings have reached their wear limit. ► Visit a qualified specialist workshop.
 (USA only)  (Canada only) Check Brake Fluid Level	There is insufficient brake fluid in the brake fluid reservoir. ▲ WARNING Braking performance can be impaired. There is a risk of an accident. ► Stop the vehicle immediately, paying attention to road and traffic conditions. Do not continue driving under any circumstances. ► Secure the vehicle to prevent it from rolling away (► page 133). ► Do not add brake fluid. Adding more will not remedy the malfunction. ► Consult a qualified specialist workshop.
EBD, ABS, ESP Inoperative 	EBD is unavailable due to a malfunction. ABS, BAS, hill start assist and ESP® as well as its driving safety systems, for example, are therefore also unavailable. ATTENTION ASSIST is deactivated and other driving systems could be automatically deactivated. ▲ WARNING The brake system continues to function normally, but without the functions listed above. The wheels could therefore lock prematurely if you brake hard, for example. This causes steerability and braking to be greatly impaired. The braking distance can increase in emergency braking situations. If ESP® is not operational, ESP® will not stabilize the vehicle. There is an increased risk of skidding and accidents. ► Switch the engine off, wait briefly and start the engine again. ► Check if the display message has disappeared and ESP® is operational. ► If the display message continues to be displayed: <ul style="list-style-type: none"> • Drive on with care. • Visit a qualified specialist workshop immediately.





Display messages	Possible causes/consequences and ► Solutions
 <p data-bbox="188 329 317 360">Inoperative</p> 	<p data-bbox="439 270 1102 354">ESP®, BAS and hill start assist are unavailable due to a malfunction. ATTENTION ASSIST is deactivated and other driving systems could be automatically deactivated.</p> <p data-bbox="452 369 602 399"> WARNING</p> <p data-bbox="439 410 1071 458">The brake system continues to function normally, but without the functions listed above.</p> <p data-bbox="439 467 1064 516">The braking distance in an emergency braking situation can thus increase.</p> <p data-bbox="439 525 1025 548">If ESP® is not operational, ESP® will not stabilize the vehicle.</p> <p data-bbox="439 557 946 580">There is an increased risk of skidding and accidents.</p> <ul style="list-style-type: none"> <li data-bbox="439 589 1050 612">► Switch the engine off, wait briefly and start the engine again. <li data-bbox="439 621 1100 670">► Check if the display message has disappeared and ESP® is operational. <li data-bbox="439 679 939 765">► If the display message continues to be displayed: <ul style="list-style-type: none"> <li data-bbox="471 709 668 732">• Drive on with care. <li data-bbox="471 741 961 765">• Visit a qualified specialist workshop immediately.
 <p data-bbox="188 844 396 874">Currently Unavail.</p> 	<p data-bbox="439 795 1102 908">ESP®, BAS and hill start assist are unavailable due to a malfunction. The self-diagnosis function, for example, may not be complete. ATTENTION ASSIST is deactivated and other driving systems could be automatically deactivated.</p> <p data-bbox="452 922 602 953"> WARNING</p> <p data-bbox="439 964 1093 1041">The brake system continues to function normally, but without the functions listed above. The wheels could therefore lock if you brake hard, for example.</p> <p data-bbox="439 1050 1064 1098">The braking distance in an emergency braking situation can thus increase.</p> <p data-bbox="439 1107 1025 1130">If ESP® is not operational, ESP® will not stabilize the vehicle.</p> <p data-bbox="439 1139 946 1163">There is an increased risk of skidding and accidents.</p> <ul style="list-style-type: none"> <li data-bbox="439 1171 1102 1268">► Drive on with care on a suitable stretch of road, making slight steering movements at a speed above 12 mph (20 km/h). If the display message disappears, the functions mentioned above are available again. <li data-bbox="439 1286 1050 1309">► Switch the engine off, wait briefly and start the engine again. <li data-bbox="439 1318 1100 1367">► Check if the display message has disappeared and ESP® is operational. <li data-bbox="439 1376 939 1462">► If the display message continues to be displayed: <ul style="list-style-type: none"> <li data-bbox="471 1406 668 1430">• Drive on with care. <li data-bbox="471 1438 961 1462">• Visit a qualified specialist workshop immediately.





Display messages	Possible causes/consequences and ► Solutions
<p> (USA only)  (Canada only)</p> <p>Release Park. Brake</p>	<p>The red  (USA only)/ (Canada only) indicator lamp in the instrument cluster lights up and a warning tone also sounds.</p> <p>You are driving with the parking brake applied or are making an emergency stop using the parking brake.</p> <p>► Release the parking brake (► page 134).</p>
<p> Malfunction Service Req.</p>	<p>The restraint system is faulty. In addition, the  warning lamp lights up in the instrument cluster.</p> <p> WARNING</p> <p>The air bags or Emergency Tensioning Devices may either be triggered unintentionally or, in the event of an accident, may not be triggered. There is an increased risk of injury.</p> <p>► Have the restraint system and its components checked immediately at a qualified specialist workshop.</p> <p>Further information on the restraint system and its components can be found under "Occupant safety" (► page 45).</p>
<p> Fr. Left Malf. Service Req. or Fr. Right Malf. Service Req.</p>	<p>The front left or right restraint system is malfunctioning. In addition, the  warning lamp lights up in the instrument cluster.</p> <p> WARNING</p> <p>The air bags or Emergency Tensioning Devices may either be triggered unintentionally or, in the event of an accident, may not be triggered. There is an increased risk of injury.</p> <p>► Have the restraint system and its components checked immediately at a qualified specialist workshop.</p>
<p>Left Curtain Airbag Service Required or Rt. Curtain Airbag Service Required</p>	<p>There is a malfunction in the left or right window curtain air bag. In addition, the  warning lamp lights up in the instrument cluster.</p> <p> WARNING</p> <p>The left or right window curtain air bag may either be triggered unintentionally or, in the event of an accident, may not be triggered. There is an increased risk of injury.</p> <p>► Have the restraint system checked immediately at a qualified specialist workshop.</p>

Lights	
Display messages	Possible causes/consequences and ► Solutions
 Check Left Low Beam or Check Right Low Beam	The left or right-hand low-beam headlamp is faulty. ► Change the bulb (> page 100).
 Chk. Trailer L. Turn Sig. or Chk. Trailer R. Turn Sig.	The left or right-hand trailer turn signal lamp is faulty. ► Change the bulb (see the trailer manufacturer's operating instructions).
 Chk. Trailer Brake Lamp	The trailer brake lamp is faulty. ► Change the bulb (see the trailer manufacturer's operating instructions).
 Chk. Trailer L. Tail Lamp or Chk. Trailer R. Tail Lamp	The left or right-hand trailer tail lamp is faulty. ► Change the bulb (see the trailer manufacturer's operating instructions).
 Auto Lamps Inopera- tive	The light sensor is faulty. The automatic headlamp feature is malfunctioning. ► Switch the light functions on/off manually (> page 94). ► Visit a qualified specialist workshop.
 Chk. Rear L. Turn Signal or Chk. Rear R. Turn Signal	The rear left-hand or rear right-hand turn signal is faulty. ► Change the bulb (> page 100).
 Chk. Front L. Turn Signal or Chk. Front R. Turn Signal	The front left-hand or front right-hand turn signal is faulty. ► Change the bulb (> page 100).
 Chk. Center Brake Lamp	The high-mounted brake lamp is faulty. ► Visit a qualified specialist workshop.
 Chk. L. Tail/ Brake Lamp or Chk. R. Tail/ Brake Lamp	The left or right-hand tail lamp/brake lamp is faulty. ► Change the bulb (> page 100).



Display messages	Possible causes/consequences and ► Solutions
 Check Left High Beam or Check Right High Beam	The left or right-hand high-beam headlamp is faulty. ► Change the bulb (▷ page 100).
 License Plate Lamp	The left or right-hand license plate lamp is faulty. ► Visit a qualified specialist workshop.
 Switch Off Lights	The lights are still switched on when you leave the vehicle. An additional warning tone sounds. ► Turn the light switch to AUTO or 0 .
 Check Left Fog Lamp or Check Right Fog Lamp	The left-hand or right-hand front fog lamp is faulty. ► Visit a qualified specialist workshop.
 Rear Fog Lamp	The rear fog lamp is faulty. ► Change the bulb (▷ page 100).
 Chk. Front L. Parking Lamp or Chk. Front R. Parking Lamp	The front left or front right parking lamp or standing lamp is faulty. ► Change the bulb (▷ page 100).
 Backup Light	The left or right-hand backup lamp is faulty. ► Change the bulb (▷ page 100).
 Check Left Tail Lamp or Check Right Tail Lamp	The left or right-hand tail lamp is faulty. ► Change the bulb (▷ page 100).
 Malfunction	The exterior lighting is faulty. ► Visit a qualified specialist workshop. Vehicles with trailer tow hitch: a fuse may be defective. ► Check the fuses and if necessary replace any blown fuses (see the "Fuse allocation" supplement). ► If the display message does not disappear, consult a qualified specialist workshop.
 Chk. L. Day Running Lgt. or Chk. R. Day Running Lgt.	The left or right-hand daytime running lamp is faulty. ► Change the bulb (▷ page 100).





Engine	
Display messages	Possible causes/consequences and ► Solutions
	<p>An additional warning tone sounds. The battery is not being charged.</p> <p>Possible causes:</p> <ul style="list-style-type: none"> • faulty alternator • torn poly-V-belt • a malfunction in the electronics <p>► Stop the vehicle immediately, paying attention to road and traffic conditions, and switch off the engine.</p> <p>! Do not continue driving. The engine could otherwise overheat.</p> <p>► Secure the vehicle to prevent it from rolling away (► page 133).</p> <p>► Consult a qualified specialist workshop.</p>
 <p>Stop Vehicle Turn Eng. Off</p>	<p>An additional warning tone sounds. The coolant is too hot.</p> <p>! WARNING</p> <p>Never drive with an overheated engine. Driving when the engine is overheated can cause fluids which may have leaked into the engine compartment to catch fire.</p> <p>In addition, steam from an overheated engine can cause serious burns, which can occur just by opening the hood.</p> <p>There is a risk of injury.</p> <p>► Stop the vehicle immediately, paying attention to road and traffic conditions, and switch off the engine.</p> <p>► Secure the vehicle to prevent it from rolling away (► page 133).</p> <p>► Wait until the engine has cooled down.</p> <p>► Make sure that the air supply to the radiator is not obstructed, by frozen slush for example.</p> <p>► Do not start the engine again until the display message goes out and the coolant temperature is below the maximum value specified. The engine could otherwise be damaged.</p> <p>► Pay attention to the coolant temperature gage (► page 173).</p> <p>► If the temperature increases again, visit a qualified specialist workshop immediately.</p> <p>Under normal operating conditions and with the specified coolant level, the coolant temperature gage may rise to 248 °F (120 °C).</p>
	<p>The fan motor is faulty.</p> <p>► Check the coolant temperature (► page 173).</p> <p>► If the coolant temperature is below the maximum value specified below, you can continue driving to the nearest qualified specialist workshop.</p> <p>Avoid heavy loads on the engine, e.g. driving in mountainous terrain, and stop-and-go traffic.</p> <p>Under normal operating conditions and with the specified coolant level, the coolant temperature gage may rise to 248 °F (120 °C).</p>

Display messages	Possible causes/consequences and ► Solutions
<p>Check Coolant Level</p> 	<p>The coolant level is too low.</p> <ul style="list-style-type: none"> ❗ Avoid making long journeys with too little coolant in the engine cooling system. The engine will otherwise be damaged. ► Add coolant, making sure to observe the warning notes (▷ page 253). ► Have the engine cooling system checked at a qualified specialist workshop if the coolant needs to be refilled more often than usual.
<p>Check Engine Oil Level</p> 	<p>An additional warning tone sounds. The engine oil level has dropped to the minimum level.</p> <ul style="list-style-type: none"> ► Check the oil level at the latest when next refueling (▷ page 252). ► If necessary, add engine oil (▷ page 253). ► To confirm the oil check: press and hold (Ⓜ). ► Have the engine checked at a qualified specialist workshop if you need to add engine oil more often than usual. <p>❗ Avoid long journeys with too little engine oil. The engine will otherwise be damaged.</p>
<p>Manually Check Oil Level</p>	<p>Reminder to check the oil level.</p> <ul style="list-style-type: none"> ► Check the oil level at the latest when next refueling (▷ page 252). ► If necessary, add engine oil (▷ page 253). <p>❗ Avoid long journeys with too little engine oil. The engine will otherwise be damaged.</p>
<p>Stop Vehicle Turn Eng. Off</p> 	<p>The oil level is too low. There is a risk of engine damage.</p> <ul style="list-style-type: none"> ► Stop the vehicle immediately, paying attention to road and traffic conditions, and switch off the engine. ► Secure the vehicle to prevent it from rolling away (▷ page 133). ► Check the oil level (▷ page 252). ► If necessary, add engine oil (▷ page 253).
<p>Reserve Fuel</p> 	<p>The fuel level has dropped to the reserve range.</p> <ul style="list-style-type: none"> ► Refuel at the nearest gas station.
	<p>There is very little fuel in the fuel tank.</p> <ul style="list-style-type: none"> ► Refuel at the nearest gas station without fail.







Driving systems



Display messages	Possible causes/consequences and ► Solutions
120 km/h!	Only for certain countries: the maximum speed has been exceeded. ► Drive more slowly.
Maximum Speed 120 km/h	Only for certain countries: the maximum speed has been exceeded. ► Drive more slowly.
 Attent. Asst Inoperative	ATTENTION ASSIST has failed. ► Visit a qualified specialist workshop.
 Attent. Asst: Take Break!	Based on certain criteria, ATTENTION ASSIST has detected fatigue or a lack of concentration on the part of the driver. An additional warning tone sounds. ► If necessary, take a break. During long journeys, take regular breaks in good time so that you get enough rest.
Cruise Control - - - mph	A condition for activating cruise control has not been met. You have tried to store a speed below 20 mph (30 km/h) for example. ► If conditions permit, drive faster than 20 mph (30 km/h) and store the speed. ► Check the activation conditions for cruise control (► page 143).

Tires	
Display messages	Possible causes/consequences and ► Solutions
Correct Tire Pressure	<p>The tire pressure is too low in at least one of the tires, or the tire pressure difference between the wheels is too great.</p> <ul style="list-style-type: none"> ► Check the tire pressure at the next opportunity (▷ page 284). ► If necessary, correct the tire pressure. ► Restart the tire pressure monitor (▷ page 287).
Check Tire Pressure Soon	<p>An additional warning tone sounds. The tire pressure in one or more tires has dropped significantly.</p> <p> WARNING</p> <p>Tire pressure that are too low pose the following hazards:</p> <ul style="list-style-type: none"> • The tires may burst, especially as the load and vehicle speed increase. • The tires may wear excessively and/or unevenly, which may greatly impair tire traction. • The handling as well as steering and braking characteristics may be severely affected. <p>There is a risk of an accident.</p> <ul style="list-style-type: none"> ► Stop the vehicle without making any sudden steering or braking maneuvers. Pay attention to the traffic conditions while doing so. ► Secure the vehicle to prevent it from rolling away (▷ page 133). ► Check the tires and, if necessary, change the wheel (▷ page 296). ► Check the tire pressure (▷ page 284). ► If necessary, correct the tire pressure.
Caution! Tire Malfunc.	<p>The tire pressure in one or more tires has dropped suddenly.</p> <p> WARNING</p> <p>Driving with a flat tire poses a risk of the following hazards:</p> <ul style="list-style-type: none"> • A flat tire affects the ability to steer or brake the vehicle. • You could then lose control of the vehicle. • Continued driving with a flat tire will cause excessive heat build-up and possibly a fire. <p>There is a risk of an accident.</p> <ul style="list-style-type: none"> ► Stop the vehicle without making any sudden steering or braking maneuvers. Pay attention to the traffic conditions while doing so. ► Secure the vehicle to prevent it from rolling away (▷ page 133). ► Check the tires and, if necessary, change the wheel (▷ page 296).

Display messages	Possible causes/consequences and ► Solutions
Tire Press. Monitor Currently Unavail.	<p>Due to a source of radio interference, no signals can be received from the wheel sensors. The tire pressure monitor is temporarily malfunctioning.</p> <p>The tire pressure monitor restarts automatically as soon as the problem has been solved.</p>
Tire Press. Monitor Inoperative	<p>The tire pressure monitor is malfunctioning and switched off. Either the installed wheels do not have suitable tire pressure sensors or the system is malfunctioning, e.g. because a tire pressure sensor is faulty.</p> <p>► Install wheels with suitable tire pressure sensors. The tire pressure monitor is activated automatically after driving for a few minutes.</p> <p>or</p> <p>► Visit a qualified specialist workshop.</p>

Vehicle

Display messages	Possible causes/consequences and ► Solutions
	<p>The tailgate is open.</p> <p>► Close the tailgate.</p>
	<p>The rear door is open.</p> <p>► Close the rear door(s).</p>
	<p>An additional warning tone sounds. The hood is open.</p> <p> WARNING</p> <p>The open hood may then block your view when the vehicle is in motion. There is a risk of an accident.</p> <p>► Stop the vehicle immediately, paying attention to road and traffic conditions.</p> <p>► Secure the vehicle to prevent it from rolling away (▷ page 133).</p> <p>► Close the hood.</p>
	<p>An additional warning tone sounds while the vehicle is in motion. The display shows the open door(s).</p> <p>► Close all doors.</p>
 <p>Pwr. Steering Mal-funct. </p>	<p>An additional warning tone sounds. The steering power assistance could be malfunctioning. You may need to steer more forcefully.</p> <p>► Carefully continue to a qualified specialist workshop and have the steering checked immediately.</p>

Display messages	Possible causes/consequences and ► Solutions
 Obtain a New Key	The SmartKey needs to be replaced. ► Visit a qualified specialist workshop.
 Add Washer Fluid	The washer fluid level in the washer fluid reservoir has dropped below the minimum. ► Add washer fluid (▷ page 256).

Display messages (vehicles with steering wheel buttons)

Introduction

Important safety notes

WARNING



If the instrument cluster has failed or malfunctioned, you may not recognize function restrictions in systems relevant to safety. The operating safety of your vehicle may be impaired. There is a risk of an accident.

Drive on carefully. Have the vehicle checked at a qualified specialist workshop immediately.

The on-board computer only shows messages or warnings from certain systems in the instrument cluster display. You should therefore make sure your vehicle is operating safely at all times. If the operating safety of your vehicle is impaired, stop the vehicle as soon as possible, paying attention to road and traffic conditions. Then consult a qualified specialist workshop.

Display messages with graphic symbols are simplified in the Operator's Manual and may differ from the symbols in the display. The display shows high-priority display messages in red. A warning tone sounds with certain display messages.





Please respond in accordance with the display messages and follow the additional notes in this Operator's Manual.



You can hide low-priority display messages using the  or  steering wheel button. The display messages are then stored in the message memory. Rectify the cause of a display message as soon as possible.

High-priority display messages cannot be hidden. These messages will continue to be shown in the display until their cause has been eliminated.

Message memory

The on-board computer stores certain display messages in the **message memory**. You can call up the stored display messages. Using the steering wheel buttons

- Press  or  to select the **Service** menu.
- Press  or  to select **Messages**.
The line shows the number of stored messages.
- Press  to confirm.
The first stored display message appears in the display.
If there are no display messages, the display shows **No Messages**.

- ▶ Press  or  to scroll through the display messages.
All of the stored display messages are numbered in the message memory. The current message number is displayed as a guide together with the number of stored display messages in the bottom line of the display.
- ▶ Press  to exit the display messages.

Safety systems

Display messages

Possible causes/consequences and ► Solutions

ABS 
Inoperative See
Operator's Manual

ABS, BAS, hill start assist, and ESP[®] as well as its driving safety systems are unavailable due to a malfunction.
ATTENTION ASSIST is deactivated and other driving systems could be automatically deactivated.

WARNING

The brake system continues to function normally, but without the functions listed above. The wheels could therefore lock if you brake hard, for example.

This causes steerability and braking to be greatly impaired. The braking distance can increase in emergency braking situations.

If ESP[®] is not operational, ESP[®] will not stabilize the vehicle.

There is an increased risk of skidding and accidents.

- ▶ Drive on with care.
- ▶ Visit a qualified specialist workshop immediately.

ABS 
Currently Unavail.
See Operator's Manual

ABS, BAS, hill start assist, and ESP[®] as well as its driving safety systems are temporarily unavailable.
ATTENTION ASSIST is deactivated and other driving systems could be automatically deactivated.
For example, the on-board voltage may be insufficient.

WARNING

The brake system continues to function normally, but without the functions listed above. The wheels could therefore lock if you brake hard, for example.

This causes steerability and braking to be greatly impaired. The braking distance can increase in emergency braking situations.

If ESP[®] is not operational, ESP[®] will not stabilize the vehicle.

There is an increased risk of skidding and accidents.









- ▶ Drive on with care and on a suitable stretch of road make slight steering movements at a speed above 12 mph (20 km/h).

If the display message continues to be displayed:





- ▶ Drive on with care.
- ▶ Visit a qualified specialist workshop immediately.





Display messages	Possible causes/consequences and ► Solutions
<p>Front Passenger Air-bag Disabled See Operator's Manual</p>	<p>The front-passenger air bag is deactivated during the journey even though the front-passenger seat is occupied by an adult or a person with a stature corresponding to that of an adult.</p> <p>If additional forces are applied to the seat or the occupant is not sitting on the seat properly (▷ page 53), the weight the system detects may be too low.</p> <p> WARNING</p> <p>The front-passenger front air bag will not deploy in the event of an accident.</p> <p>There is an increased risk of injury.</p> <ul style="list-style-type: none"> ▶ Stop the vehicle immediately, paying attention to road and traffic conditions. ▶ Secure the vehicle to prevent it from rolling away (▷ page 133). ▶ Switch off the ignition. ▶ The front passenger must get out of the vehicle. ▶ Make sure that the front-passenger seat is unoccupied, close the front-passenger door and switch on the ignition. ▶ Observe the PASSENGER AIRBAG OFF indicator lamp in the center console and the display messages and check the following: <p>Seat unoccupied and ignition switched on:</p> <ul style="list-style-type: none"> • The PASSENGER AIRBAG OFF indicator lamp must light up continuously. If the indicator lamp is on, the Occupant Classification System (OCS) has disabled the front-passenger air bag (▷ page 53). • The display must not show the messages Front Passenger Air-bag Enabled See Operator's Manual or Front Passenger Airbag Disabled See Operator's Manual. <ul style="list-style-type: none"> ▶ Wait for at least one minute until the necessary system checks have been completed. ▶ Ensure that the display does not show either of the two display messages about the front-passenger front air bag. <p>If these conditions are met, the front-passenger seat can be occupied again.</p> <p>If these conditions are not met, the Occupant Classification System (OCS) is malfunctioning.</p> <ul style="list-style-type: none"> ▶ Visit a qualified specialist workshop immediately. <p>Further information on the Occupant Classification System (OCS) can be found under "Occupant Classification System (OCS)" (▷ page 53).</p>

Display messages	Possible causes/consequences and ► Solutions
<p>Front Passenger Air-bag Enabled See Operator's Manual</p>	<p>The front-passenger front air bag is enabled during the journey even though the front-passenger seat:</p> <ul style="list-style-type: none"> • is occupied by a child in a child restraint system, or a person of small stature or • is not occupied. <p>The system may detect objects or forces that are adding to the weight applied to the seat.</p> <p> WARNING</p> <p>The front-passenger air bag may deploy unintentionally. There is an increased risk of injury.</p> <ul style="list-style-type: none"> ► Stop the vehicle immediately, paying attention to road and traffic conditions. ► Secure the vehicle to prevent it from rolling away (► page 133). ► Switch off the ignition. ► Open the front-passenger door. ► Remove the child and the child restraint system from the front-passenger seat. ► Make sure there are no objects applying additional weight to the seat. <ul style="list-style-type: none"> The system may otherwise detect the additional weight and interpret the vehicle seat occupant's weight as greater than it actually is. ► Make sure that the front-passenger seat is unoccupied, close the front-passenger door and switch on the ignition. ► Observe the PASSENGER AIRBAG OFF indicator lamp in the center console and the display and check the following: <p>Seat unoccupied and ignition switched on:</p> <ul style="list-style-type: none"> • The PASSENGER AIRBAG OFF indicator lamp must light up continuously. If the indicator lamp is on, the Occupant Classification System (OCS) has disabled the front-passenger air bag (► page 53). • The display must not show the messages Front Passenger Air-bag Enabled See Operator's Manual or Front Passenger Airbag Disabled See Operator's Manual. ► Wait for at least one minute until the necessary system checks have been completed. ► Ensure that the display does not show either of the two display messages about the front-passenger front air bag. <p>If these conditions are met, the front-passenger seat can be occupied again. Observe the notes on the Occupant Classification System (OCS) (► page 53).</p> <p>If these conditions are not met, the Occupant Classification System (OCS) is malfunctioning.</p> <ul style="list-style-type: none"> ► Install the child restraint system on a suitable rear seat. or ► Seat a person of small stature on a suitable rear seat.



Display messages	Possible causes/consequences and ► Solutions
	<p>► Visit a qualified specialist workshop immediately.</p> <p>Further information on the Occupant Classification System (OCS) can be found under "Occupant Classification System (OCS)" (► page 53).</p>
 Check Brake Pad Wear	<p>The brake pads/linings have reached their wear limit.</p> <p>► Visit a qualified specialist workshop.</p>
 (USA only)  (Canada only) Check Brake Fluid Level	<p>There is insufficient brake fluid in the brake fluid reservoir.</p> <p> WARNING</p> <p>Braking performance can be impaired. There is a risk of an accident.</p> <ul style="list-style-type: none"> ► Stop the vehicle immediately, paying attention to road and traffic conditions. Do not continue driving under any circumstances. ► Secure the vehicle to prevent it from rolling away (► page 133). ► Do not add brake fluid. Adding more will not remedy the malfunction. ► Consult a qualified specialist workshop immediately.
   Inoperative See Operator's Manual	<p>EBD is unavailable due to a malfunction. ABS, BAS, hill start assist and ESP® as well as its driving safety systems, for example, are therefore also unavailable.</p> <p>ATTENTION ASSIST is deactivated and other driving systems could be automatically deactivated.</p> <p> WARNING</p> <p>The brake system continues to function normally, but without the functions listed above. The wheels could therefore lock prematurely if you brake hard, for example.</p> <p>This causes steerability and braking to be greatly impaired. The braking distance can increase in emergency braking situations.</p> <p>If ESP® is not operational, ESP® will not stabilize the vehicle.</p> <p>There is an increased risk of skidding and accidents.</p> <ul style="list-style-type: none"> ► Drive on with care. ► Visit a qualified specialist workshop immediately.











Display messages	Possible causes/consequences and ► Solutions
 <p>Inoperative See Operator's Manual</p>	<p>ESP®, BAS and hill start assist are unavailable due to a malfunction. ATTENTION ASSIST is deactivated and other driving systems could be automatically deactivated.</p> <p>⚠ WARNING</p> <p>The brake system continues to function normally, but without the functions listed above.</p> <p>The braking distance in an emergency braking situation can thus increase.</p> <p>If ESP® is not operational, ESP® will not stabilize the vehicle. There is an increased risk of skidding and accidents.</p> <ul style="list-style-type: none"> ► Drive on with care. ► Visit a qualified specialist workshop immediately.
 <p>Currently Unavail. See Operator's Manual</p>	<p>ESP®, BAS and hill start assist are unavailable due to a malfunction. The self-diagnosis function, for example, may not be complete. ATTENTION ASSIST is deactivated and other driving systems could be automatically deactivated.</p> <p>⚠ WARNING</p> <p>The brake system continues to function normally, but without the functions listed above. The wheels could therefore lock if you brake hard, for example.</p> <p>The braking distance in an emergency braking situation can thus increase.</p> <p>If ESP® is not operational, ESP® will not stabilize the vehicle. There is an increased risk of skidding and accidents.</p> <ul style="list-style-type: none"> ► Drive on with care on a suitable stretch of road, making slight steering movements at a speed above 12 mph (20 km/h). If the display message disappears, the functions mentioned above are available again. <p>If the display message continues to be displayed:</p> <ul style="list-style-type: none"> ► Drive on with care. ► Visit a qualified specialist workshop immediately.
<p>PARK (USA only)  (Canada only)</p> <p>Release Parking Brake</p>	<p>The red PARK (USA only) /  (Canada only) indicator lamp in the instrument cluster lights up and a warning tone also sounds.</p> <p>You are driving with the parking brake applied or are making an emergency stop using the parking brake.</p> <ul style="list-style-type: none"> ► Release the parking brake (► page 134).

Display messages	Possible causes/consequences and ► Solutions
 <p>SRS Malfunction: Service Required</p>	<p>The restraint system is faulty. In addition, the  warning lamp lights up in the instrument cluster.</p> <p>⚠ WARNING</p> <p>The air bags or Emergency Tensioning Devices may either be triggered unintentionally or, in the event of an accident, may not be triggered. There is an increased risk of injury.</p> <p>► Have the restraint system and its components checked immediately at a qualified specialist workshop.</p> <p>Further information on the restraint system and its components can be found under "Occupant safety" (► page 45).</p>
 <p>Front Left Malfunction: Service Required or Front Right Malfunction: Service Required</p>	<p>The front left or right restraint system is malfunctioning. In addition, the  warning lamp lights up in the instrument cluster.</p> <p>⚠ WARNING</p> <p>The air bags or Emergency Tensioning Devices may either be triggered unintentionally or, in the event of an accident, may not be triggered. There is an increased risk of injury.</p> <p>► Have the restraint system and its components checked immediately at a qualified specialist workshop.</p>
 <p>Left Curtain Airbag Malfunction: Service Required or Rt. Curtain Airbag Malfunction: Service Required</p>	<p>There is a malfunction in the left or right window curtain air bag. In addition, the  warning lamp lights up in the instrument cluster.</p> <p>⚠ WARNING</p> <p>The left or right window curtain air bag may either be triggered unintentionally or, in the event of an accident, may not be triggered. There is an increased risk of injury.</p> <p>► Have the restraint system checked immediately at a qualified specialist workshop.</p>

Lights

Display messages	Possible causes/consequences and ► Solutions
 <p>Check Left Low Beam or Check Right Low Beam</p>	<p>The left or right-hand low-beam headlamp is faulty.</p> <p>► Change the bulb (► page 100).</p>
 <p>Check Trailer Left Turn Signal or Check Trailer Right Turn Signal</p>	<p>The left or right-hand trailer turn signal lamp is faulty.</p> <p>► Change the bulb (see the trailer manufacturer's operating instructions).</p>

Display messages	Possible causes/consequences and ► Solutions
 Check Trailer Brake Lamp	<p>The trailer brake lamp is faulty.</p> <p>► Change the bulb (see the trailer manufacturer's operating instructions).</p>
 Check Trailer Left Tail Lamp or Check Trailer Right Tail Lamp	<p>The left or right-hand trailer tail lamp is faulty.</p> <p>► Change the bulb (see the trailer manufacturer's operating instructions).</p>
 Auto Lamp Function Inoperative	<p>The light sensor is faulty. The automatic headlamp feature is malfunctioning.</p> <p>► Switch the light functions on/off manually (► page 94).</p> <p>► Visit a qualified specialist workshop.</p>
 Check Rear Left Turn Signal or Check Rear Right Turn Signal	<p>The rear left-hand or rear right-hand turn signal is faulty.</p> <p>► Change the bulb (► page 100).</p>
 Check Front Left Turn Signal or Check Front Right Turn Signal	<p>The front left-hand or front right-hand turn signal is faulty.</p> <p>► Change the bulb (► page 100).</p>
 Check Center Brake Lamp	<p>The high-mounted brake lamp is faulty.</p> <p>► Visit a qualified specialist workshop.</p>
 Check Left Tail and Brake Lamps or Check Right Tail and Brake Lamps	<p>The left or right-hand tail lamp/brake lamp is faulty.</p> <p>► Change the bulb (► page 100).</p>
 Check Left High Beam or Check Right High Beam	<p>The left or right-hand high-beam headlamp is faulty.</p> <p>► Change the bulb (► page 100).</p>
 License Plate Lamp	<p>The left or right-hand license plate lamp is faulty.</p> <p>► Visit a qualified specialist workshop.</p>

Display messages	Possible causes/consequences and ► Solutions
 Switch Off Lights	The lights are still switched on when you leave the vehicle. An additional warning tone sounds. ► Turn the light switch to AUTO or 0 .
 Check Left Fog Lamp or Check Right Fog Lamp	The left-hand or right-hand front fog lamp is faulty. ► Visit a qualified specialist workshop.
 Rear Fog Lamp	The rear fog lamp is faulty. ► Change the bulb (▷ page 100).
 Check Front Left Parking Lamp or Check Front Right Parking Lamp	The front left or front right parking lamp or standing lamp is faulty. ► Change the bulb (▷ page 100).
 Backup Light	The left or right-hand back-up lamp is faulty. ► Change the bulb (▷ page 100).
 Check Left Tail Lamp or Check Right Tail Lamp	The left or right-hand tail lamp is faulty. ► Change the bulb (▷ page 100).
 Malfunction See Operator's Manual	The exterior lighting is faulty. ► Visit a qualified specialist workshop. Vehicles with trailer tow hitch: a fuse may be defective. ► Check the fuses and if necessary replace any blown fuses (see the "Fuse allocation" supplement). ► If the display message does not disappear, consult a qualified specialist workshop.
 Check Left Daytime Running Light or Check Rt. Daytime Running Light	The left or right-hand daytime running lamp is faulty. ► Change the bulb (▷ page 100).

Engine

Display messages

Possible causes/consequences and ► Solutions



An additional warning tone sounds. The battery is not being charged.

Possible causes:

- faulty alternator
- torn poly-V-belt
- a malfunction in the electronics

► Stop the vehicle immediately, paying attention to road and traffic conditions, and switch off the engine.

! Do not continue driving. The engine could otherwise overheat.

- Secure the vehicle to prevent it from rolling away (► page 133).
- Consult a qualified specialist workshop.



Coolant Too Hot:
Stop Vehicle Turn
Engine Off

An additional warning tone sounds. The coolant is too hot.

⚠ WARNING











Never drive with an overheated engine. Driving when the engine is overheated can cause fluids which may have leaked into the engine compartment to catch fire.



In addition, steam from an overheated engine can cause serious burns, which can occur just by opening the hood.

There is a risk of injury.

- Stop the vehicle immediately, paying attention to road and traffic conditions, and switch off the engine.
- Secure the vehicle to prevent it from rolling away (► page 133).
- Wait until the engine has cooled down.
- Make sure that the air supply to the radiator is not obstructed, by frozen slush for example.
- Do not start the engine again until the display message goes out and the coolant temperature is below the maximum value specified. The engine could otherwise be damaged.
- Monitor the  coolant temperature gage in the instrument cluster.
- If the temperature increases again, visit a qualified specialist workshop immediately.



Under normal operating conditions and with the specified coolant level, the  gage may rise to 248 °F (120 °C).

Display messages	Possible causes/consequences and ► Solutions
	<p>The fan motor is faulty.</p> <ul style="list-style-type: none"> ► Check the  coolant temperature gage in the instrument cluster. <p>If the coolant temperature is below the maximum value specified below, you can continue driving to the nearest qualified specialist workshop.</p> <p>Avoid heavy loads on the engine, e.g. driving in mountainous terrain, and stop-start traffic.</p> <p>Under normal operating conditions and with the specified coolant level, the  gage may rise to 248 °F (120 °C).</p>
 <p>Check Coolant Level See Oper. Manual</p>	<p>The coolant level is too low.</p> <ul style="list-style-type: none"> ! Avoid making long journeys with too little coolant in the engine cooling system. The engine will otherwise be damaged. ► Add coolant, making sure to observe the warning notes (► page 253). ► Have the engine cooling system checked at a qualified specialist workshop if the coolant needs to be refilled more often than usual.
 <p>Check Engine Oil At Next Refueling</p>	<ul style="list-style-type: none"> ► Check the oil level at the latest when next refueling (► page 252). ► If necessary, add engine oil (► page 253). ► To confirm the oil check: press . ► Have the engine checked at a qualified specialist workshop if you need to add engine oil more often than usual. <p>! Avoid long journeys with too little engine oil. The engine will otherwise be damaged.</p>
 <p>Manually Check Oil Level</p>	<p>Reminder to check the oil level.</p> <ul style="list-style-type: none"> ► Check the oil level at the latest when next refueling (► page 252). ► If necessary, add engine oil (► page 253). <p>! Avoid long journeys with too little engine oil. The engine will otherwise be damaged.</p>
 <p>Eng. Oil Level Low: Stop Vehicle Turn Engine Off</p>	<p>The oil level is too low. There is a risk of engine damage.</p> <ul style="list-style-type: none"> ► Stop the vehicle immediately, paying attention to road and traffic conditions, and switch off the engine. ► Secure the vehicle to prevent it from rolling away (► page 133). ► Check the oil level (► page 252). ► If necessary, add engine oil (► page 253).
 <p>Fuel Level Low</p>	<p>The fuel level has dropped to the reserve range.</p> <ul style="list-style-type: none"> ► Refuel at the nearest gas station.
	<p>There is very little fuel in the fuel tank.</p> <ul style="list-style-type: none"> ► Refuel at the nearest gas station without fail.

Driving systems	
Display messages	Possible causes/consequences and ► Solutions
120 km/h! Maximum Speed Exceeded	Only for certain countries: the maximum speed has been exceeded. ► Drive more slowly.
 Attention Assist Inoperative	ATTENTION ASSIST has failed. ► Visit a qualified specialist workshop.
Attention Assist: Take a Break!	Based on certain criteria, ATTENTION ASSIST has detected fatigue or a lack of concentration on the part of the driver. An additional warning tone sounds. ► If necessary, take a break. During long journeys, take regular breaks in good time so that you get enough rest.
Park Assist Canceled	Additionally, a warning tone sounds. The active parking assistance has been canceled and Active Parking Assist has ended automatically. For example, you have touched the steering wheel or driven too fast. ► Steer and brake yourself. ► Repeat the parking procedure if necessary. Observe the deactivation conditions as you do so (> page 158).
Park Assist Inoperative	PARKTRONIC is malfunctioning or faulty. ► Follow the instructions and helpful hints in the "Problems with PARKTRONIC" section (> page 154). ► If the display message continues to be shown, consult a qualified specialist workshop.
	Active Parking Assist is unavailable or faulty. ► Switch off the ignition. ► Start the engine again. ► If the display message continues to be shown or symbol  is not shown in the display, consult a qualified specialist workshop.
Collision Prevention Assist Inoperative	COLLISION PREVENTION ASSIST PLUS is not available due to a malfunction. ► Visit a qualified specialist workshop.

Display messages	Possible causes/consequences and ► Solutions
<p>Collision Prevention Assist Currently Unavail. See Oper. Manual</p>	<p>COLLISION PREVENTION ASSIST PLUS is temporarily inoperative. Possible causes:</p> <ul style="list-style-type: none"> • The sensors in the front bumper are dirty. • The function is impaired due to heavy rain or snow. • The radar sensor system is temporarily inoperative, e.g. due to electromagnetic radiation emitted by nearby TV or radio stations or other sources of electromagnetic radiation. • The system is outside the operating temperature range. • The on-board voltage is too low. <p>Once the causes listed above no longer apply, the display message goes out and COLLISION PREVENTION ASSIST is operational again. If the display message does not disappear:</p> <ul style="list-style-type: none"> ► Pull over and stop the vehicle, paying attention to road and traffic conditions. ► Secure the vehicle to prevent it from rolling away (▷ page 133). ► Switch off the engine. ► Clean the sensors in the front bumper (▷ page 266). ► Restart the engine.
<p>Lane Keeping Assist Inoperative</p>	<p>Lane Keeping Assist is faulty.</p> <ul style="list-style-type: none"> ► Visit a qualified specialist workshop.
<p>Lane Keeping Assist Currently Unavail. See Oper. Manual</p>	<p>Lane Keeping Assist is deactivated and temporarily inoperative. Possible causes:</p> <ul style="list-style-type: none"> • The windshield is dirty in the camera's field of vision. • Visibility is impaired due to heavy rain, snow or fog. • There are no lane markings for an extended period. • The lane markings are worn away, dark or covered, e.g. by dirt or snow. <p>Once the causes listed above no longer apply, the display message goes out and Lane Keeping Assist is operational again. If the display message does not disappear:</p> <ul style="list-style-type: none"> ► Pull over and stop the vehicle, paying attention to road and traffic conditions. ► Secure the vehicle to prevent it from rolling away (▷ page 133). ► Clean the windshield.
<p>Cruise Control LDC_Spd_Dsr speedUnit</p>	<p>A condition for activating cruise control has not been met. You have tried to store a speed below 20 mph (30 km/h) for example.</p> <ul style="list-style-type: none"> ► If conditions permit, drive faster than 20 mph (30 km/h) and store the speed. ► Check the activation conditions for cruise control (▷ page 143).







Display messages	Possible causes/consequences and ► Solutions
Blind Spot Assist Inoperative	Blind Spot Assist is faulty. ► Visit a qualified specialist workshop.
Blind Spot Assist Currently Unavail. See Operator's Manual	Blind Spot Assist is temporarily inoperative. Possible causes: <ul style="list-style-type: none"> • You have attached a trailer. • The sensors in the rear bumper are dirty. • The function is impaired due to heavy rain or snow. • The radar sensor system is temporarily inoperative, e.g. due to electromagnetic radiation emitted by nearby TV or radio stations or other sources of electromagnetic radiation. • The system is outside the operating temperature range. Once the causes listed above no longer apply, the display message goes out and Blind Spot Assist is operational again. If the display message does not disappear: <ul style="list-style-type: none"> ► Pull over and stop the vehicle, paying attention to road and traffic conditions. ► Secure the vehicle to prevent it from rolling away (► page 133). ► Switch off the engine. ► Clean the sensors in the rear bumper (► page 266). ► Restart the engine.

Tires	
Display messages	Possible causes/consequences and ► Solutions
Adjust Tire Pressure	<p>The tire pressure is too low in at least one of the tires, or the tire pressure difference between the wheels is too great.</p> <ul style="list-style-type: none"> ► Check the tire pressure at the next opportunity (▷ page 284). ► If necessary, correct the tire pressure. ► Restart the tire pressure monitor (▷ page 287).
Check Tires	<p>An additional warning tone sounds.</p> <p>The tire pressure in one or more tires has dropped significantly. The display shows the wheel position.</p> <p> WARNING</p> <p>Underinflated tires pose the following risks:</p> <ul style="list-style-type: none"> • The tires may burst, especially as the load and vehicle speed increase. • The tires may wear excessively and/or unevenly, which may greatly impair tire traction. • The handling as well as steering and braking characteristics may be severely affected. <p>There is a risk of an accident.</p> <ul style="list-style-type: none"> ► Stop the vehicle without making any sudden steering or braking maneuvers. Pay attention to the traffic conditions while doing so. ► Secure the vehicle to prevent it from rolling away (▷ page 133). ► Check the tires and, if necessary, change the wheel (▷ page 296). ► Check the tire pressure (▷ page 284). ► If necessary, correct the tire pressure.
Warning Tire Malfunction	<p>The tire pressure in one or more tires has dropped suddenly. The display shows the wheel position.</p> <p> WARNING</p> <p>Driving with a flat tire poses a risk of the following hazards:</p> <ul style="list-style-type: none"> • A flat tire affects the ability to steer or brake the vehicle. • You could then lose control of the vehicle. • Continued driving with a flat tire will cause excessive heat build-up and possibly a fire. <p>There is a risk of an accident.</p> <ul style="list-style-type: none"> ► Stop the vehicle without making any sudden steering or braking maneuvers. Pay attention to the traffic conditions while doing so. ► Secure the vehicle to prevent it from rolling away (▷ page 133). ► Check the tires and, if necessary, change the wheel (▷ page 296).
Tire Pressure Monitor Currently Unavailable	<p>Due to a source of radio interference, no signals can be received from the wheel sensors. The tire pressure monitor is temporarily malfunctioning.</p> <p>The tire pressure monitor restarts automatically as soon as the problem has been solved.</p>

Display messages	Possible causes/consequences and ► Solutions
Wheel Sensor(s) Missing	There is no signal from the tire pressure sensor of one or several wheels. The pressure of the affected tire is not shown in the display. ► Have the faulty tire pressure sensor replaced at a qualified specialist workshop.
Tire Pressure Monitor Inoperative No Wheel Sensors	The wheels installed do not have suitable tire pressure sensors. The tire pressure monitor is deactivated. ► Install wheels with suitable tire pressure sensors. The tire pressure monitor is activated automatically after driving for a few minutes.
Tire Press. Monitor Inoperative	The tire pressure monitor is malfunctioning. ► Visit a qualified specialist workshop.

Vehicle

Display messages	Possible causes/consequences and ► Solutions
Shift to 'P' or 'N' to Start Engine	You have attempted to start the engine with the transmission in position R or D . ► Shift the transmission to position P or N .
Auxiliary Battery Malfunction	The auxiliary battery for the transmission is no longer being charged. ► Visit a qualified specialist workshop.
Apply Brake to Shift from 'P'	You have attempted to move the transmission selector lever to position D , R or N without depressing the brake pedal. ► Depress the brake pedal.
Risk of Rolling: Transmission Not in P	An additional warning tone sounds. The driver's door is open and the transmission is in position R , N or D . ► Shift the transmission to position P . ► Secure the vehicle to prevent it from rolling away (▷ page 133).
Service Required Do Not Shift Gears Visit Dealer	An additional warning tone sounds. You cannot change the transmission position due to a malfunction. If transmission position D is selected: ► Drive to a qualified specialist workshop without shifting the transmission from position D . If transmission position R , N or P is selected: ► Consult a qualified specialist workshop.
Only Shift to 'P' when Vehicle is Stationary	The vehicle is still moving. ► Pull over and stop the vehicle, paying attention to road and traffic conditions. ► Shift the transmission to position P .

Display messages	Possible causes/consequences and ► Solutions
	The tailgate is open. ► Close the tailgate.
	The rear door is open. ► Close the rear door(s).
	An additional warning tone sounds. The hood is open. ⚠ WARNING The open hood may then block your view when the vehicle is in motion. There is a risk of an accident. ► Stop the vehicle immediately, paying attention to road and traffic conditions. ► Secure the vehicle to prevent it from rolling away (▷ page 133). ► Close the hood.
	An additional warning tone sounds while the vehicle is in motion. The display shows the open door(s). ► Close all doors.
 Power Steering Mal- function See Oper. Manual	An additional warning tone sounds. The steering power assistance could be malfunctioning. You may need to steer more forcefully. ► Carefully continue to a qualified specialist workshop and have the steering checked immediately.
 Obtain a New Key	The key needs to be replaced. ► Visit a qualified specialist workshop.
Phone No Service	Your vehicle is outside the network provider's transmitter/receiver range.
 Check Washer Fluid	The washer fluid level in the washer fluid reservoir has dropped below the minimum. ► Add washer fluid (▷ page 256).

Indicator and warning lamps in the instrument cluster

General notes

When switching on the ignition, some systems carry out a self-test. Some indicator and warning lamps may temporarily turn on or start to flash. This is not an indication of any problem. Only when these indicator and warning lights turn on or start flashing after the engine has started or during the journey has a malfunction occurred.

Seat belts

Warning/
indicator
lamp

▷ Signal type

Possible causes/consequences and ► Solutions



▷ After starting the engine, the red seat belt warning lamp lights up or flashes. A warning tone may also sound.

Only for certain countries: the red seat belt warning lamp lights up for a maximum of 6 seconds after the ignition is switched on.

The seat belt warning lamp reminds the driver and front-passenger to fasten their seat belts.

► Fasten seat belt (▷ page 48).



▷ The red seat belt warning lamp lights up after the engine starts, as soon as the driver's or the front-passenger door is closed.

The driver or front-passenger has not fastened their seat belt.

► Fasten seat belt (▷ page 48).

The warning lamp goes out.

On vehicles with the Occupant Classification System (OCS), there are objects on the front-passenger seat.

► Remove the objects from the front-passenger seat and store them in a safe place.

The warning lamp goes out.



▷ The red seat belt warning lamp flashes and an intermittent audible warning sounds.

The driver or front passenger has not fastened their seat belt. At the same time, you are driving faster than 15 mph (25 km/h) or have briefly driven faster than 15 mph (25 km/h).

► Fasten seat belt (▷ page 48).

The warning lamp goes out and the intermittent audible warning ceases.

On vehicles with the Occupant Classification System (OCS), there are objects on the front-passenger seat. At the same time, you are driving faster than 15 mph (25 km/h) or have briefly driven faster than 15 mph (25 km/h).

► Remove the objects from the front-passenger seat and store them in a safe place.

The warning lamp goes out and the intermittent warning tone ceases.

Safety systems

Warning/
indicator
lamp

▷ Signal type

Possible causes/consequences and ▶ Solutions

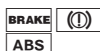

▷ **BRAKE** (USA only) or  (Canada only): the ABS and brake warning lamps are lit while the engine is running.

EBD is unavailable due to a malfunction. ABS, BAS, hill start assist and ESP® as well as its driving safety systems, for example, are therefore also unavailable.

ATTENTION ASSIST is deactivated and other driving systems could be automatically deactivated.

 **WARNING**

The brake system continues to function normally, but without the functions listed above. The wheels could therefore lock prematurely if you brake hard, for example. This causes steerability and braking to be greatly impaired. The braking distance can increase in emergency braking situations.

If ESP® is not operational, ESP® will not stabilize the vehicle.

There is an increased risk of skidding and accidents.

- ▶ Switch the engine off, wait briefly and start the engine again.
- ▶ Check if the display message has disappeared and ESP® is operational.
- ▶ If the display message continues to be displayed:
 - Drive on with care.
 - Visit a qualified specialist workshop immediately.



▷ The red **BRAKE** (USA only) or  (Canada only) brake system warning lamp is lit while the engine is running. An additional warning tone sounds.

There is insufficient brake fluid in the brake fluid reservoir.

 **WARNING**

Braking performance can be impaired.

There is a risk of an accident.

- ▶ Stop the vehicle immediately, paying attention to road and traffic conditions. Do not continue driving under any circumstances.
- ▶ Secure the vehicle to prevent it from rolling away (▷ page 133).
- ▶ Do not add brake fluid. Adding more will not remedy the malfunction.
- ▶ Consult a qualified specialist workshop.
- ▶ Observe the display messages.

Warning/
indicator
lamp

▷ Signal type

Possible causes/consequences and ► Solutions



▷ The yellow ABS warning lamp is lit while the engine is running.

ABS has been deactivated due to a malfunction. BAS, hill start assist and ESP® as well as its driving safety systems, for example, are therefore also deactivated.

ATTENTION ASSIST is deactivated and other driving systems could be automatically deactivated.

WARNING

The brake system continues to function normally, but without the functions listed above. The wheels could therefore lock prematurely if you brake hard, for example.

This causes steerability and braking to be greatly impaired. The braking distance can increase in emergency braking situations.

If ESP® is not operational, ESP® will not stabilize the vehicle.

There is an increased risk of skidding and accidents.

- ▶ Switch the engine off, wait briefly and start the engine again.
- ▶ Check if the display message has disappeared and ESP® is operational.
- ▶ If the display message continues to be displayed:
 - Drive on with care.
 - Visit a qualified specialist workshop immediately.

If the ABS control unit is faulty, there is also a possibility that other systems, such as the automatic transmission, will be restricted or unavailable.



▷ The yellow ESP® warning lamp flashes while the vehicle is in motion.

ESP® or traction control is intervening because there is a risk of skidding or at least one wheel has started to spin.

Cruise control is automatically deactivated.

- ▶ When starting off, do not depress the accelerator pedal more than is necessary.
- ▶ Ease off the accelerator pedal while driving.
- ▶ Adapt your driving style to suit the weather and road conditions.
- ▶ Do not deactivate ESP®.

In rare cases, it may be best to deactivate ESP® (> page 66).

**Warning/
indicator
lamp****▷ Signal type****Possible causes/consequences and ▶ Solutions**

▷ The yellow ESP® warning lamp is lit while the engine is running.

ESP®, BAS, hill start assist, ESP® trailer stabilization and Crosswind Assist are unavailable due to a malfunction.

ATTENTION ASSIST is deactivated and other driving systems could be automatically deactivated.

 **WARNING**

The brake system continues to function normally, but without the functions listed above.

The braking distance in an emergency braking situation can thus increase.

If ESP® is not operational, ESP® will not stabilize the vehicle.

There is an increased risk of skidding and accidents.

- ▶ Switch the engine off, wait briefly and start the engine again.
- ▶ Check if the display message has disappeared and ESP® is operational.
- ▶ If the display message continues to be displayed:
 - Drive on with care.
 - Visit a qualified specialist workshop immediately.

**Warning/
indicator
lamp****▷ Signal type****Possible causes/consequences and ▶ Solutions**

▷ The yellow ESP[®] OFF warning lamp is lit while the engine is running or the ECO start/stop function is activated.

ESP[®] is deactivated. ESP[®] trailer stabilization and Crosswind Assist are deactivated.

 WARNING

If ESP[®] is deactivated, vehicle stabilization assistance is significantly reduced. There is an increased risk of skidding and accidents.

- ▶ Reactivate ESP[®].
In rare cases, it may be best to deactivate ESP[®] (> page 66).
- ▶ Adapt your driving style to suit the weather and road conditions.

If ESP[®] cannot be activated:

- ▶ Drive on with care.
- ▶ Have ESP[®] checked at a qualified specialist workshop.



▷ The red restraint system warning lamp is lit while the engine is running. The restraint system is faulty.

 WARNING

The air bags or Emergency Tensioning Devices may either be triggered unintentionally or, in the event of an accident, may not be triggered.

There is an increased risk of injury.

- ▶ Observe the display messages.
- ▶ Drive on with care.
- ▶ Have the restraint system and its components checked immediately at a qualified specialist workshop.

Further information on the restraint system and its components can be found under "Occupant safety" (> page 45).

Engine

Warning/
indicator
lamp

▷ Signal type

Possible causes/consequences and ▶ Solutions



▷ The yellow Check Engine warning lamp lights up while the engine is running. There may be a malfunction, for example:

- in the engine management
- in the transmission management
- in the fuel injection system
- in the exhaust system
- in the ignition system (for vehicles with a gasoline engine)
- in the fuel system

The emission limit values may be exceeded and the engine may be running in emergency mode.

▶ Have the vehicle checked as soon as possible at a qualified specialist workshop.



▷ The yellow reserve fuel warning lamp is on while the engine is running. The fuel level has dropped to the reserve range.

▶ Refuel at the nearest gas station.



▷ The red coolant warning lamp comes on while the engine is running.

On vehicles without steering wheel buttons, the coolant temperature gage is at the start of the bar display (▷ page 173).

On vehicles with steering wheel buttons, the coolant temperature gage is at the start of the scale in the instrument cluster (▷ page 39).

The temperature sensor for the coolant temperature gage is faulty.

The coolant temperature is no longer being monitored. There is a risk of engine damage if the coolant temperature is too high.

- ▶ Stop the vehicle immediately, paying attention to road and traffic conditions, and switch off the engine. Do not continue driving under any circumstances.
- ▶ Secure the vehicle to prevent it from rolling away (▷ page 133).
- ▶ Consult a qualified specialist workshop.

Warning/
indicator
lamp

▷ Signal type

Possible causes/consequences and ► Solutions



▷ The red coolant warning lamp comes on while the engine is running.

The coolant level is too low.

If the coolant level is correct, the airflow to the engine radiator may be blocked or the electric engine radiator fan may be malfunctioning.

The coolant is too hot and the engine is no longer being cooled sufficiently.

- ▶ Observe the display messages.
- ▶ Stop the vehicle immediately, paying attention to road and traffic conditions, and switch off the engine.
- ▶ Secure the vehicle to prevent it from rolling away (▷ page 133).
- ▶ Exit the vehicle and keep a safe distance from the vehicle until the engine has cooled down.
- ▶ Check the coolant level and add coolant, observing the warning notes (▷ page 253).
- ▶ If you have to add coolant more frequently, have the engine cooling system checked.
- ▶ Make sure that the air supply to the radiator is not obstructed, by frozen slush for example.
- ▶ Check the coolant temperature:
 - using the display in the on-board computer on vehicles without steering wheel buttons (▷ page 173)
 - using the analog display in the instrument cluster on vehicles with steering wheel buttons (▷ page 39)
- ▶ Do not start the engine again until the coolant temperature is below the maximum value specified below. The engine could otherwise be damaged.
- ▶ Drive to the nearest qualified specialist workshop.
Avoid heavy loads on the engine, e.g. driving in mountainous terrain, and stop-start traffic.

Under normal operating conditions and with the specified coolant level, the coolant temperature gage may rise to 248 °F (120 °C).



▷ The red coolant warning lamp comes on while the engine is running. An additional warning tone sounds.

The coolant temperature has exceeded the maximum value specified below. The airflow to the engine radiator may be blocked or the coolant level may be too low.

⚠ WARNING

The engine is not being cooled adequately and could become damaged.

Never drive with an overheated engine. Otherwise, fluids which may have leaked into the engine compartment could catch fire.



In addition, steam from an overheated engine can cause serious burns, which can occur just by opening the hood.

There is a risk of injury.

- ▶ Observe the display messages.
- ▶ Stop the vehicle immediately, paying attention to road and traffic conditions, and switch off the engine.
- ▶ Secure the vehicle to prevent it from rolling away (▷ page 133).

Warning/ indicator lamp	▶ Signal type Possible causes/consequences and ▶ Solutions
	<ul style="list-style-type: none"> ▶ Exit the vehicle and keep a safe distance from the vehicle until the engine has cooled down. ▶ Check the coolant level and add coolant, observing the warning notes (▶ page 253). ▶ If you have to add coolant more frequently, have the engine cooling system checked. ▶ Make sure that the air supply to the radiator is not obstructed, by frozen slush for example. ▶ Check the coolant temperature: <ul style="list-style-type: none"> • using the display in the on-board computer on vehicles without steering wheel buttons (▶ page 173) • using the analog display in the instrument cluster on vehicles with steering wheel buttons (▶ page 39) ▶ If the coolant temperature is below the maximum value specified below, you can continue driving to the nearest qualified specialist workshop. Avoid heavy loads on the engine, e.g. driving in mountainous terrain, and stop-start traffic. <p>Under normal operating conditions and with the specified coolant level, the coolant temperature gage may rise to 248 °F (120 °C).</p>

Driving systems

Warning/ indicator lamp	▶ Signal type Possible causes/consequences and ▶ Solutions
	<p>▶ The red distance warning lamp lights up while the vehicle is in motion. The distance to the vehicle in front is too small for the speed selected.</p> <ul style="list-style-type: none"> ▶ Increase the distance.
	<p>▶ The red distance warning lamp lights up while the vehicle is in motion. An additional warning tone sounds.</p> <p>You are approaching a vehicle or a stationary obstacle in your line of travel at too high a speed.</p> <ul style="list-style-type: none"> ▶ Be prepared to brake immediately. ▶ Pay particular attention to the traffic situation. You may have to brake or take evasive action. <p>Further information about the distance warning function can be found under "COLLISION PREVENTION ASSIST" (▶ page 144).</p>

Tires

Warning/
indicator
lamp

▷ Signal type

Possible causes/consequences and ▶ Solutions



▷ The yellow tire pressure monitor warning lamp (pressure loss/malfunction) is lit. The tire pressure monitor has detected a loss of pressure in at least one of the tires.

WARNING

Underinflated tires pose the following risks:

- The tires may burst, especially as the load and vehicle speed increase.
- The tires may wear excessively and/or unevenly, which may greatly impair tire traction.
- The handling as well as steering and braking characteristics may be severely affected.
There is a risk of an accident.
- ▶ Stop the vehicle without making any sudden steering or braking maneuvers. Pay attention to the traffic conditions while doing so.
- ▶ Secure the vehicle to prevent it from rolling away (▷ page 133).
- ▶ Observe the display messages.
- ▶ Check the tires and, if necessary, change the wheel (▷ page 296).
- ▶ Check the tire pressure.
You can check the tire pressure electronically on vehicles with steering wheel buttons (▷ page 284).
- ▶ If necessary, correct the tire pressure.



▷ The yellow tire pressure monitor (pressure loss/malfunction) warning lamp flashes for approximately one minute and then remains lit. The tire pressure monitor is malfunctioning.

WARNING

The system may not be able to detect or signal low tire pressure as intended. There is a risk of an accident.

- ▶ Observe the display messages.
- ▶ Visit a qualified specialist workshop.

Vehicle**Warning/
indicator
lamp****▷ Signal type****Possible causes/consequences and ▶ Solutions**

▷ The red power steering warning lamp is lit while the engine is running. An additional warning tone sounds.

The steering power assistance could be malfunctioning. You may need to steer more forcefully.

- ▶ Carefully continue to a qualified specialist workshop and have the steering checked immediately.



▷ The yellow "door open" indicator lamp is lit.

A door is not fully closed.

- ▶ Close the doors.

Introduction

Important safety notes

WARNING

If you operate information systems and communication equipment integrated in the vehicle while driving, you will be distracted from traffic conditions. You could also lose control of the vehicle. There is a risk of an accident.

Only operate the equipment when the traffic situation permits. If you are not sure that this is possible, park the vehicle paying attention to traffic conditions and operate the equipment when the vehicle is stationary.

Observe the legal requirements for the country you are in.

WARNING

Operating mobile information systems and communication devices while driving will distract you from traffic conditions. In addition, you could then lose control of the vehicle. There is a risk of an accident.

Only operate these devices when the vehicle is stationary.

WARNING

Handling discs while driving may distract you from traffic conditions. You could also lose control of the vehicle. There is a risk of an accident.

Handle discs only when the vehicle is stationary.

Bear in mind that at a speed of just 30 mph (approximately 50 km/h), your vehicle is covering a distance of 44 feet (approximately 14 m) per second.

WARNING

SD cards are small parts. They can be swallowed and cause choking. This poses an increased risk of injury or even fatal injury.

Keep the SD card out of the reach of children. If a SD card is swallowed, seek medical attention immediately.

WARNING

The CD/DVD drive is a class 1 laser product. If you open the housing of the CD/DVD drive, there is a risk of exposure to invisible laser radiation. This laser radiation could damage your retina. There is a risk of injury.

Never open the housing. Always have maintenance and repair work carried out at a qualified specialist workshop.

WARNING

Modifications to electronic components, their software as well as wiring can impair their function and/or the function of other networked components. In particular, systems relevant to safety could also be affected. As a result, these may no longer function as intended and/or jeopardize the operating safety of the vehicle. There is an increased risk of an accident and injury.

Never tamper with the wiring as well as electronic components or their software. You should have all work to electrical and electronic equipment carried out at a qualified specialist workshop.

When using the device please follow:

- the safety notes in these operating instructions
- traffic rules and regulations
- motor vehicle laws and safety standards

General notes

These brief instructions only describe the basic operation of your multimedia system.

All further information on the individual functions can be found on the Internet at www.mercedes-benz.de/betriebsanleitung-transporter.

Protection against theft

The multimedia system is equipped with technical provisions to protect it against theft.

Further information about anti-theft protection can be obtained at a qualified specialist workshop.

Detailed information on protection against theft is available at your authorized Sprinter Dealer.

In order to render the multimedia system useless for thieves, it is protected by a four-digit

security code. If the multimedia system was disconnected from the power supply, you will need to enter this security code after switching the multimedia system on.



Audio 15

Overview

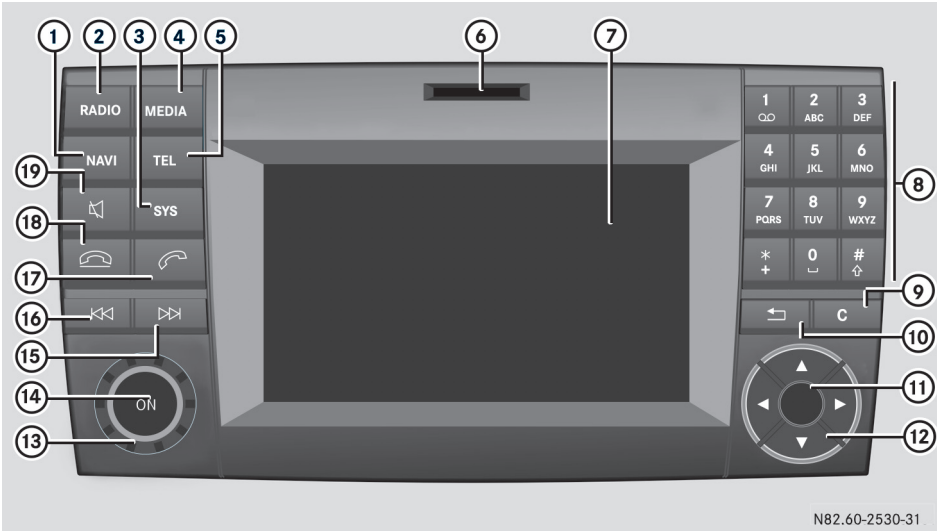

N82.60-2530-31

	Function	Page
①	NAVI Selects navigation	236
②	RADIO Selects the radio Selects the waveband	
③	sys Selects system settings	
④	MEDIA Selects audio source	235
⑤	TEL Selects the telephone function	236
⑥	SD memory card slot	
⑦	Display	233

	Function	Page
⑧	0 to 9 * # Radio mode: Sets the frequency manually Stores and calls up a station Media mode: Selects a track Telephone mode: Telephone number entry Bluetooth® mode: Passkey entry	236 234
⑨	c Deletes characters When route guidance is active: cancels route guidance	
⑩	← Exits menu or jumps up one menu level higher When route guidance is active: jumps to main menu	

	Function	Page
⑪	Control knob Turn: selects menus and entries Press: confirms selection/entry	
⑫	▲ / ▼ Selects the previous/next line in the menu ◀ / ▶ Within a menu: Jumps one entry to the left/right Jumps up one menu level higher/jumps back to the main menu Shows other editing options/menus	
⑬	Ⓞ Turn: Sets the volume	
⑭	Ⓞ Press: Switches on/off	
⑮	▶▶ Radio mode: Press briefly: station search Press and hold: sets a station Media mode: Press briefly: skips forward Press and hold: fast forwards	

	Function	Page
⑯	⏮ Radio mode: Press briefly: station search Press and hold: sets a station Media mode: Press briefly: skips back Press and hold: rewinds	
⑰	☎ Accepts a call Makes a call	236
⑱	☎ Ends a call Rejects a call	
⑲	🔇 Mute Pauses SD memory card/USB device Switches the hands-free system on/off	



- ① Status bar
- ② Main menu bar

- ③ Display/selection window
- ④ Menu bar

The display shows the function currently selected with its current settings and associated menus ④. The following functions and menus are available:

Operation	Menu
Navigation system	via Becker® MAP PILOT
Radio	Radio Presets FM Sound

Operation	Menu
SD memory card	SD Music Media Sound
USB device	USB Music Media Sound
AUX	AUX Volume Sound
BT Audio	BT Audio Media Sound
Telephone	Telephone Call lists
System	Settings Display off

Bluetooth® settings

Requirements for a Bluetooth® connection

You can connect Bluetooth®-compatible mobile phones and other audio equipment to the multimedia system.

To do so, the following conditions must be met:

- The Bluetooth® device must be located inside the vehicle in the vicinity of the multimedia system.
- Bluetooth® must be activated on both the multimedia system and on the respective Bluetooth® device.
- The Bluetooth® device must be visible for the multimedia system.

i You can obtain further information about suitable mobile phones and connecting mobile phones via Bluetooth® at any qualified specialist workshop.

i You can obtain further information about suitable mobile phones and connecting

mobile phones via Bluetooth® at any authorized Sprinter Dealer.

Activating/deactivating the Bluetooth® function

- ▶ Press the button.
- ▶ Press the button repeatedly until the menu bar is selected.
- ▶ Select **Settings**.
- ▶ Select **Activate Bluetooth**.
- ▶ Activate or deactivate the Bluetooth® function using the control knob.
A tick in front of the **Activate Bluetooth** message indicates that the Bluetooth® function is activated.

i The Bluetooth® function will remain switched on until you switch it off again.



Searching for and pairing with a Bluetooth® device

- ▶ Press the button.
- or
- ▶ Select the Bluetooth® audio function.
 - ▶ Press the button repeatedly until the menu bar is selected.
 - ▶ Select **Telephone/BT Audio**.
 - ▶ **Bluetooth telephones/Bluetooth device list**.
 - ▶ Select **Update**.
The multimedia system searches for Bluetooth® devices within range for a certain period of time.



If at least one Bluetooth® device is found, the display shows the Bluetooth® name of the device.

If the multimedia system does not find a Bluetooth® device, the **Search for Bluetooth devices failed** message is shown in the display.

- ▶ **To search again:** select **Update**.
- ▶ **To select a Bluetooth® device:** select the desired Bluetooth® device using the control knob.
The display shows the input menu for the passkey.

- ▶ **To enter the passkey:** enter an easy to remember, four-digit number using the  to  number keys.
 - ▶ To confirm the entry: select **OK**.
The Bluetooth® device is authorized.
 - ▶ Select Bluetooth® device name **MB Bluetooth** on the device.
 - ▶ Enter the four-digit number selected previously on the Bluetooth® device, and confirm.
 - ▶ Confirm possible prompts using the Bluetooth® device.
The **Authorization successful**. message is shown in the display. You will see the Bluetooth® name of the Bluetooth® device in the display/selection window.
- i** When the **Authorization failed**. message is displayed, you may have exceeded the prescribed time period. Repeat the procedure.
- If the pairing process was successful, the Bluetooth® device is automatically connected to the multimedia system.

Unpairing a Bluetooth® device

- ▶ Press the  button.
- or
- ▶ Select the Bluetooth® audio function.
 - ▶ Press the  button repeatedly until the menu bar is selected.
 - ▶ Select **Telephone/BT Audio**.
 - ▶ **Bluetooth telephones/Bluetooth device list**.
The display shows all paired Bluetooth® devices. The current Bluetooth® device is identified by the • dot.
 - ▶ Select the Bluetooth® device to be unpaired.
 - ▶ Select the list symbol next to the entry using the  button.
 - ▶ Select **De-authorize**.
A prompt appears in the display asking whether the Bluetooth® device should be de-authorized.

- ▶ **To unpair:** select **Yes**.
The Bluetooth® device is unpaired and deleted from the device list.
- ▶ **To cancel the unpairing process:** select **No**.
The Bluetooth® device is not unpaired from the multimedia system. You have canceled the process.

Ending a Bluetooth® connection

- i** If you end the Bluetooth® connection, the Bluetooth® device is not deleted from the multimedia system memory.

A Bluetooth® connection can be ended in the following ways:

- deactivate the Bluetooth® function of the multimedia system.
- deactivate the Bluetooth® function of your Bluetooth® device.
- switch off the multimedia system.
- switch off the Bluetooth® device.

Media mode

Memory card audio playback

- ▶ **To insert the SD memory card:** insert the SD memory card into the SD slot with the contacts at the front and facing downwards.
- ▶ Press the  button repeatedly, until the display in the menu bar shows **SD**.
Playback starts.

- i** If the multimedia system cannot find any readable files on the SD memory card, the display shows **No Playable Files**.

- ▶ **To remove the SD memory card:** press the SD memory card.
The multimedia system ejects the SD memory card.





USB device audio playback

The connection for USB devices is located in the left-hand stowage compartment, next to the multimedia system.

- ▶ Connect the USB device to the USB port in the correct position.
- ▶ Press the  button repeatedly, until the display in the menu bar shows **USB**. Playback starts.
- i** Due to the wide range of USB devices available on the market, playback cannot be guaranteed for all USB device brands.

Audio playback from a Bluetooth® device

Requirement: the Bluetooth® audio device is paired and connected to the multimedia system.

- ▶ Press the  button repeatedly until **BT Audio** is shown in the display.
- ▶ Press the  button repeatedly until the menu bar is selected.
- ▶ **To start playback:** select  in the menu bar. Playback starts.
- ▶ **To stop playback:** select  in the menu bar. Playback stops.

Audio playback via the AUX jack

- ▶ Connect an external device to the AUX jack.
- ▶ Press the  button repeatedly until the display shows **AUX**. The multimedia system plays the external device and produces sound through the loudspeakers again.





Telephone mode



"999" or "112" emergency call

Making emergency calls without entering a PIN is only possible using the mobile phone.

The **999** or **112** emergency call number is a public service. Any misuse is punishable by law.

Making a call

- ▶ Press the  button.
- ▶ Enter the desired phone number using the  to  number keys and the  button.
- ▶ **To delete individual digits:** press the  button.

- ▶ **To delete the entire numerical sequence:** press and hold the  button until the entire numerical sequence is deleted.
- ▶ **To make a call:** press the  button. This initiates dialing.
- ▶ **To cancel dialing:** press the  button when dialing.

Navigation system

Important safety notes

WARNING

If you operate information systems and communication equipment integrated in the vehicle while driving, you will be distracted from traffic conditions. You could also lose control of the vehicle. There is a risk of an accident. Only operate the equipment when the traffic situation permits. If you are not sure that this is possible, park the vehicle paying attention to traffic conditions and operate the equipment when the vehicle is stationary.

Observe the legal requirements for the country you are in.

The multimedia system calculates the route to the destination without taking account of the following, for example:

- traffic lights
- stop and give way signs
- parking or stopping restrictions
- road narrowing
- other road and traffic rules and regulations

The multimedia system may provide incorrect navigation announcements if the surroundings do not correspond to the data on the digital map. For example, a route may have been diverted or the direction of a one-way street may have changed.

For this reason, you must always observe road and traffic rules and regulations during your journey. Road and traffic rules and regulations always have priority over the system's driving recommendations.

GPS reception

Correct functioning of the navigation system depends, amongst other aspects, on GPS reception. In certain situations, GPS reception may be impaired, there may be interference or there may be no reception at all, e.g. in tunnels or parking garages.

Preparing navigation

Inserting the navigation module

- i** Switch off the ignition before removing or inserting the navigation module.
- ▶ Open the glove box.
- ▶ Insert the navigation module into the device holder.
The battery built into the navigation module starts charging when the vehicle ignition is switched on.
- ▶ Remove the catch on the front side of the device holder.
This way, the navigation module is secured, as well as protected against theft.
- ▶ Close the glove box.

Switching on the navigation system

- ▶ Press the **NAVI** button.
- or
- ▶ Press the **▲** button repeatedly until the main menu bar is selected.
 - ▶ Select **Navi**.
The display shows the main menu of the navigation system.
- i** If the battery was completely discharged, it takes up to 1 minute before the navigation system is ready.

Useful information

This Operator's Manual describes all models as well as standard and optional equipment of your vehicle that were available at the time of going to print. Country-specific variations are possible. Note that your vehicle may not be equipped with all of the described functions. This also applies to systems and functions relevant to safety.

Read the information on qualified specialist workshops (▷ page 31).

Stowage spaces and stowage compartments

Important safety notes

WARNING

If you transport objects in the vehicle interior and these are not adequately secured, they could slip or be flung around and thereby strike vehicle occupants. In addition, cup holders, open stowage spaces and mobile phone brackets may not always be able to hold the objects placed in them in the event of an accident. There is a risk of injury, particularly in the event of sharp braking or sudden changes of direction.

- Always stow objects in such a way that they cannot be tossed about in these or similar situations.
- Always make sure that objects do not protrude out of the stowage spaces, luggage nets or stowage nets.
- Ensure that closable stowage spaces are shut before beginning your journey.
- Always stow and secure heavy, hard, pointed, sharp-edged, fragile or large objects in the cargo compartment.

Observe the "Loading guidelines" (▷ page 242).

Glove box

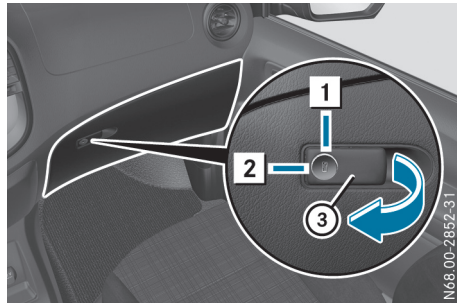

Glove box (example: glove box with a lockable lid)

- 1 Unlocked
- 2 Locked
- 3 Glove box handle

You can lock and unlock the glove box using the mechanical key (▷ page 70).

When you open the glove box flap, a coin holder, a pen holder and a credit card holder are integrated on the inside.

- ▶ **To open:** unlock the glove box lid if necessary.
- ▶ Pull glove box handle 3 in the direction of the arrow.
- ▶ **To close:** fold the glove box up and press it until it engages.

Eyeglasses compartment in the overhead control panel

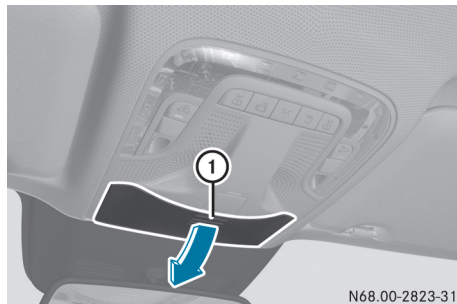

Eyeglasses compartment (example: luxury overhead control panel)

- ▶ **To open:** briefly press cover ①.
The eyeglasses compartment opens downwards.
- ▶ **To close:** press the eyeglasses compartment into the overhead control panel until it engages.

Make sure that the eyeglasses compartment is always closed while the vehicle is in motion.

Stowage net

You can use the stowage nets on the back of the seat backrests to store small, lightweight items. Observe the loading directions (▷ page 242) and the safety information about the stowage spaces (▷ page 238).

Sun visors

Overview

WARNING

If the mirror cover of the vanity mirror is folded up when the vehicle is in motion, you could be blinded by incident light. There is a risk of an accident.

Always keep the mirror cover folded down while driving.

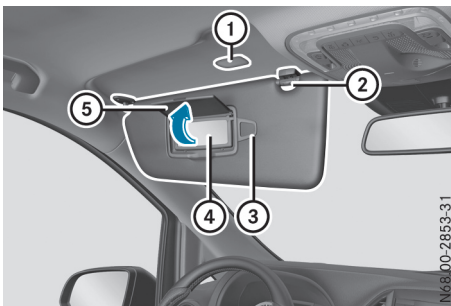

Sun visor (example with illuminated vanity mirror)

- ① Mirror light
- ② Retainer
- ③ Retaining clip, e.g. for a car park ticket
- ④ Vanity mirror
- ⑤ Mirror cover

Vanity mirror in the sun visor

- ▶ Fold up mirror cover ⑤.
- ▶ Turn the key to position **1** or **2** in the ignition lock.
Mirror lamp ① lights up.

Glare from the side

- ▶ Fold the sun visor down.
- ▶ Pull the sun visor out of bracket ②.
- ▶ Swing the sun visor to the side.

Cup holder

Important safety notes

WARNING

The cup holder cannot hold a container secure whilst traveling. If you use a cup holder whilst traveling, the container may be flung around and liquid may be spilled. The vehicle occupants may come into contact with the liquid and if it is hot, they may be scalded. You may be distracted from the traffic conditions and you could lose control of the vehicle. There is a risk of an accident and injury.

Only use the cup holder when the vehicle is stationary. Only use the cup holder for containers of the right size. Always close the container, particularly if the liquid is hot.

- ❗ Only use the cup holders for containers of the right size and which have lids. The drinks could otherwise spill.

Observe the loading guidelines (▷ page 242).

Cup holders in the dashboard

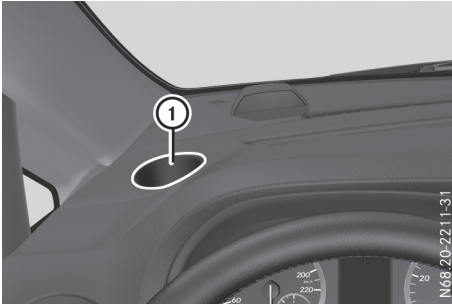

Cup holder in the dashboard (example: left side of vehicle)



Cup holders ① are located on the left and the right on top of the dashboard and on the center console.

Bottle holder

The bottle holders are in front of the stowage compartments in the front doors. There are additional bottle holders on the left and right in the rear compartment side paneling. Observe the safety notes (> page 238).

Ashtray

Front ashtray

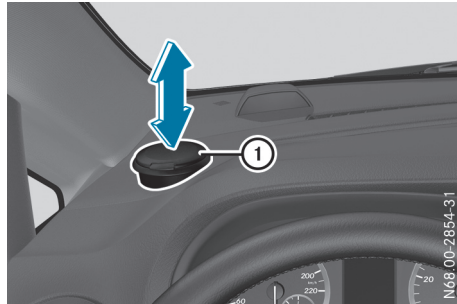

Ashtray

Ashtray with lid ① can be inserted into a cup holder on the dashboard or into a cup holder in the rear compartment.

Cigarette lighter

Important safety notes

WARNING

You can burn yourself if you touch the hot heating element or the socket of the cigarette lighter.

In addition, flammable materials can ignite if:

- the hot cigarette lighter falls
- a child holds the hot cigarette lighter to objects, for example

There is a risk of fire and injury.

Always hold the cigarette lighter by the knob. Always make sure that the cigarette lighter is out of reach of children. Never leave children unsupervised in the vehicle.

Above all, pay attention to traffic conditions. You could otherwise cause an accident and injure yourself and others. Only operate the cigarette lighter if traffic conditions permit.

Cigarette lighter in the front compartment

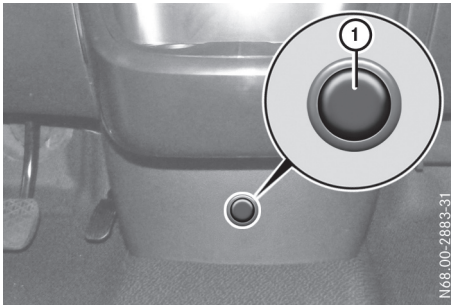

- ▶ **To use the cigarette lighter:** turn the key to position 1 in the ignition lock (▷ page 12 1).
- ▶ Press in cigarette lighter ①. The cigarette lighter will pop out automatically when the heating element is red-hot.
- ▶ Pull the cigarette lighter out of the socket by its handle.

The cigarette lighter socket can be used for accessories with a maximum power consumption of 180 W (15 A).

If you use the sockets to connect accessories for long periods when the engine is switched off, the starter battery may discharge. An emergency cut-off ensures that the on-board voltage does not drop too low. If the on-board voltage is too low, power to the socket is automatically cut. This ensures that there is sufficient power to start the engine.

12 V socket

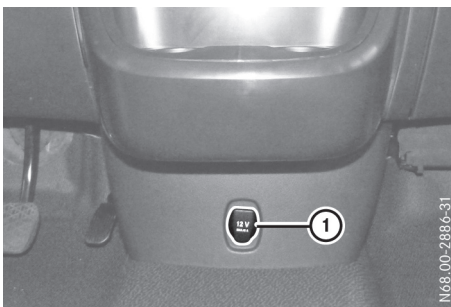

When the key is turned to position 1 in the ignition lock, the sockets can be used for accesso-

ries with a maximum power consumption of 180 W (15 A).

If you use the sockets for long periods when the engine is switched off, the starter battery may discharge. If the on-board voltage is too low, it might then no longer be possible to start the engine.

The socket in the center console and the socket in the side of the cargo compartment are not automatically deactivated if the on-board voltage is low. The additional sockets in the rear compartment are automatically deactivated if the on-board voltage is low.

Additional 12 V sockets may be located in the corner trim next to the tailgate and in the side trim on the left and right-hand sides.

- ▶ Lift up the cover of socket ①.

Mobile communications equipment

⚠ WARNING

Operating mobile information systems and communication devices while driving will distract you from traffic conditions. In addition, you could then lose control of the vehicle. There is a risk of an accident.

Only operate these devices when the vehicle is stationary.

Observe the legal requirements for the country in which you are currently driving when operating mobile communication equipment.

Please remember, a navigation system does not supply information on the load-bearing capacity of bridges or the overhead clearance of underpasses. The driver remains responsible for safety at all times.

You and others can suffer health-related damage through electromagnetic radiation. By using an exterior antenna, a possible health risk caused by electromagnetic fields, as discussed in scientific circles, is taken into account. Only have the exterior antenna installed by a qualified specialist workshop.

Failure to observe the Mercedes-Benz installation specifications can result in the invalidation of your vehicle's operating permit.

You will find information on retrofitting electrical or electronic equipment under "Vehicle electronics" (▷ page 303).

Useful information

This Operator's Manual describes all models as well as standard and optional equipment of your vehicle that were available at the time of going to print. Country-specific variations are possible. Note that your vehicle may not be equipped with all of the described functions. This also applies to systems and functions relevant to safety.

Read the information on qualified specialist workshops (▷ page 31).

Loading guidelines

Important safety notes

WARNING

When objects are unsecured or inadequately secured, they can slip, turn over or be thrown about, striking vehicle occupants. This also applies to:

- luggage or loads
- seats which have been removed and are being transported in the vehicle in an exceptional case.

There is a risk of injury, particularly in the event of a braking maneuver or abrupt change in direction.

Always stow objects in such a way that they cannot be tossed about. Before traveling, secure objects, luggage or loads to prevent them slipping or tipping over. If you remove a seat, store it preferably outside the vehicle.

WARNING

As a result of improperly placed or unevenly distributed loads, the center of gravity of the load being transported may be too high or too far back. This can significantly impair handling as well as steering and braking characteristics. There is a risk of an accident.

Always make sure that the center of gravity of the load is:

- between the axles

and

- as low as possible, near the rear axle.

WARNING

When the permissible wheel loads, axle loads and/or the maximum permissible gross vehicle weight are exceeded, driving safety is compromised. The handling as well as steering and braking characteristics may be significantly impaired. Overloaded tires may overheat, causing them to burst. There is a risk of an accident.

When transporting a load, always observe the permissible wheel loads, axle loads and the maximum permissible gross vehicle weight for the vehicle (including occupants).

 If you are using a roof carrier, observe the maximum roof load and maximum roof carrier load.

- Do not stack luggage or loads higher than the backrests.
- Objects to be transported should preferably be stowed in the cargo compartment.
- When transporting luggage, always use the cargo tie-down rings for securing loads and a cargo net, if installed.
- Use cargo tie-down rings and fasteners which are suitable for the weight and size of the load.

When using suitable load securing aids and tie downs, always follow the manufacturer's operating instructions, in particular the notes on discard criteria contained therein.

Load securing aids or tie downs must not be used if:

- identification marks are missing or illegible
- there are yarn breakages, damage to bearing seams or other signs of tearing
- there are signs of shearing, deformation, pinching or other damage
- there is damage to clamping or connecting elements

Load securing aids and tie downs in this condition are ready for discard and must be replaced. If you use load securing aids or tie downs which are worn out, the load may not be sufficiently secured and could cause damage to property.

In the event of an accident, have a damaged cargo compartment floor or loading area, the cargo tie-down rings and the tie down checked at a specialist workshop. Otherwise, the load may not be correctly secured the next time anything is stowed.

Even if you follow all loading guidelines, the load increases the risk of injury in the event of an accident. Observe the information in the "Securing a load" (▷ page 244) and "Load distribution" (▷ page 243) sections.

You will find information about the maximum roof load under "Cargo tie-down points and carrier systems" (▷ page 312). You will find information about roof carriers under "Carrier systems" (▷ page 248).

Before loading

! The anti-slip mats cannot be used for securing goods and must be replaced when they show signs of:

- Permanent deformation and crushing
- Crack formation
- Cuts

▶ **Tire pressure:** check the tire pressure and correct if necessary (▷ page 280).

▶ **Cargo compartment floor:** clean the cargo compartment floor.

The cargo compartment floor must be free from oil and dust, dry and swept clean to prevent the load from slipping.

▶ Place non-slip mats (anti-slip mats) on the cargo compartment floor if necessary.

During loading

▶ Observe the gross axle weight rating and permissible gross vehicle weight for your vehicle. Take into account that your vehicle's curb weight is increased if accessories or optional

equipment are installed. The maximum payload is thus reduced.

▶ Observe the notes on load distribution (▷ page 243).

The overall center of gravity of the load should always be as low as possible, centered and between the axles near the rear axle.

▶ Secure the load (▷ page 244).

Observe the legal requirements of the country in which you are currently driving.

Checks after loading

WARNING

Combustion engines emit poisonous exhaust gases such as carbon monoxide. If the tailgate/rear door is open when the engine is running, particularly if the vehicle is moving, exhaust fumes could enter the passenger compartment. There is a risk of poisoning.

Turn off the engine before opening the tailgate/rear door. Never drive off with the tailgate/rear door open.

▶ **Securing luggage/loads:** make sure that the luggage and/or load is secure before every journey and at regular intervals during a long journey, and correct it if necessary.

▶ **Doors/tailgate:** close the sliding doors and tailgate/door.

▶ **Tire pressure:** adjust the tire pressure according to the vehicle load (▷ page 280).

▶ **Driving style:** adapt your driving style according to the vehicle load.

Load distribution

General notes

! Excessive loads on individual points of the cargo floor or on the load surface impair vehicle handling characteristics and could cause damage to the floor covering.

The overall center of gravity of the load should always be as low as possible, centered and between the axles near the rear axle.

- ▶ Always transport loads in the cargo compartment and with the seat backrests folded up and properly locked in position.
- ▶ Always place the load against the backrests of the front or rear seats.
- ▶ Move large and heavy loads as far towards the front of the vehicle as possible against the front or rear seats. Stow the load flush with the rear or front seats.
- ▶ Always additionally secure the load with suitable load-securing aids or tie downs.

Observe the following notes:

- Do not stack loads higher than the upper edge of the backrests.
- Transport loads behind seats that are not occupied.
- If the rear bench seat is not occupied, insert the seat belts crosswise into the buckle of the opposite seat belt.

Cargo compartment variations

You can vary the cargo compartment according to your transportation requirements as follows:

- by folding the seat backrests forward to the table position.
- by removing the rear bench seat.

You will find information about rear bench seats in the "Rear bench seats" section (> page 86).

Securing loads

Important safety notes

WARNING

If you attach the tie-down incorrectly when securing the load, the following may occur in the event of abrupt changes in direction, braking maneuvers or an accident:

- the cargo tie-down rings may become detached or the tie-down may tear if the permissible load is exceeded
- the load may not be restrained.

This may cause the load to slip, tip over or be tossed about, striking vehicle occupants. There is a risk of an accident and injury.

Always tension the tie-downs in the proper manner and only between the described cargo tie-down rings. Always use tie-downs designed specifically for the loads.

- ❗ Observe the information on the maximum loading capacity of the individual cargo tie-down points.

If you use several cargo tie-down points to secure a load, you must always take the maximum loading capacity of the weakest cargo tie-down point into account.

If you brake hard, for example, the forces acting could be up to several times the weight force of the load. Always use multiple cargo tie-down points in order to distribute the force absorption. Load the anchorages evenly.

Spread the load evenly across the cargo tie-down points/cargo tie-down rings. You will find information on the maximum loading capacity of the cargo tie-down points under "Cargo tie-down points and carrier systems" (> page 312).

Do not attempt to modify or repair the cargo tie-down points/cargo tie-down rings or tie downs. Read the information on qualified specialist workshops: (> page 31).

As the driver, you are responsible for ensuring that:

- The load is secured against slipping, tipping, rolling or falling off in normal traffic conditions, should the vehicle swerve to avoid an obstacle, in the event of full brake application and on poor road surfaces.
- The applicable requirements and guidelines relating to load-securing practices must be met.

If this is not the case, this may constitute a punishable offense, depending on local legislation and any ensuing consequences.

Always observe the legal requirements for the country you are currently in.

Make sure that the load is secure before every journey and at regular intervals during a long journey. Correct an incorrectly or inadequately secured load if necessary.

Always observe the operating instructions or the notes of the lashing strap manufacturer for the operation of the lashing strap.

You can obtain information about securing the load correctly from the manufacturer of the load securing aids or tie down for securing the load.

Also observe the safety information in the loading directions (> page 242).

- ▶ Fill spaces between the load and the cargo compartment walls or wheel housings (form-locking). Use rigid load securing aids, such as wedges, wooden fixings or padding.
- ▶ Attach secured and stabilized loads in all directions to the cargo tie-down rings and the guide rails in the rear.

Only use tie downs, such as lashing nets and lashing straps, that have been tested in accordance with current standards.

When securing a load, always use the closest cargo tie-down rings and pad sharp edges for protection.

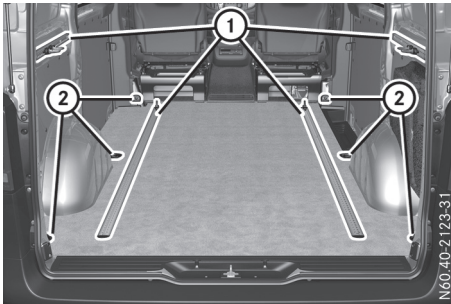

Cargo tie-down points (example: Cargo Van)

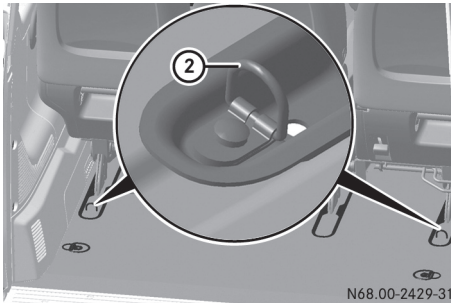

Fixed cargo tie-down points on the floor

- ① Guide/load rails
- ② Cargo tie-down rings

If your vehicle is equipped with guide/loading rails ① in the floor, you can place lashing rods directly in front of and behind the load. The lashing rods directly absorb the potential shifting forces.

Securing loads on the cargo compartment floor by lashing them down is only recommended for

lightweight loads. Place non-slip mats (anti-slip mats) under the load to increase load security.

Lashing straps

Important safety notes

⚠ WARNING

If you attach the tie-down incorrectly when securing the load, the following may occur in the event of abrupt changes in direction, braking maneuvers or an accident:

- the cargo tie-down rings may become detached or the tie-down may tear if the permissible load is exceeded
- the load may not be restrained.

This may cause the load to slip, tip over or be tossed about, striking vehicle occupants. There is a risk of an accident and injury.

Always tension the tie-downs in the proper manner and only between the described cargo tie-down rings. Always use tie-downs designed specifically for the loads.

❗ Observe the information on the maximum loading capacity of the individual cargo tie-down points.

If you use several cargo tie-down points to secure a load, you must always take the maximum loading capacity of the weakest cargo tie-down point into account.

If you brake hard, for example, the forces acting could be up to several times the weight force of the load. Always use multiple cargo tie-down points in order to distribute the force absorption. Load the anchorages evenly.

Always observe the operating instructions or the notes of the lashing strap manufacturer for the operation of the lashing strap.

Securing loads on the cargo compartment floor by lashing them down is only recommended for lightweight loads. Place non-slip mats (anti-slip mats) under the load to increase load security.

Notes and information on:

- the operation of the cargo tie-down rings and cargo tie-down points can be found in the "Securing a load" section (▷ page 244)
- the maximum loading capacity of the cargo tie-down points can be found in the "Technical data" section (▷ page 312)
- the maximum loading capacity of the lashing strap can be found on the lashing strap label. If the label is missing or illegible, the lashing strap is ready to be discarded. Such a lashing strap must be removed from use.

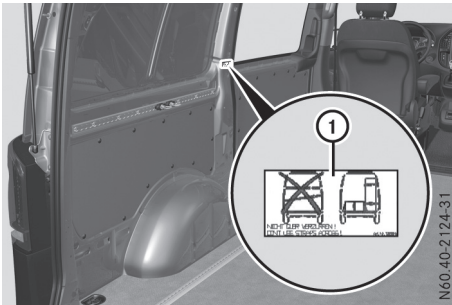

If stickers have been included in the delivery:

- ▶ Clean the surface before sticker ① is affixed. The stickers must be affixed to a flat, metallic surface free from grease and dust.
- ▶ Affix stickers ① on every side of the vehicle in close proximity to the loading rails in a clearly visible location.

Tensioning strap

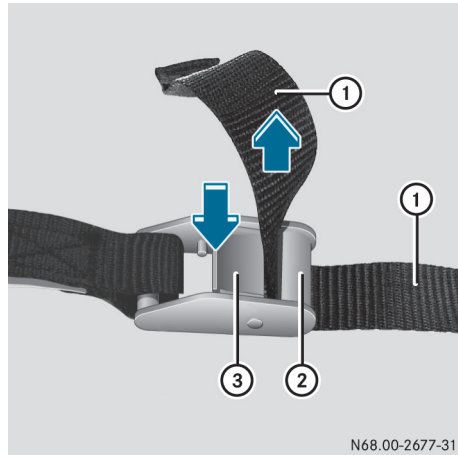

- ▶ Observe the important safety notes (▷ page 245) and the tips in the "Securing a load" sections (▷ page 244).
- ▶ **To tighten the tensioning strap:** press tensioning lever ③ and keep it pressed.
- ▶ Guide tensioning strap ① between tensioning lever ③ and brace ② as illustrated and tighten it.
- ▶ Release tensioning lever ③.
- ▶ **To release the tensioning strap:** press tensioning lever ③ and pull tensioning strap ① out from the strap buckle.

Ratchet strap

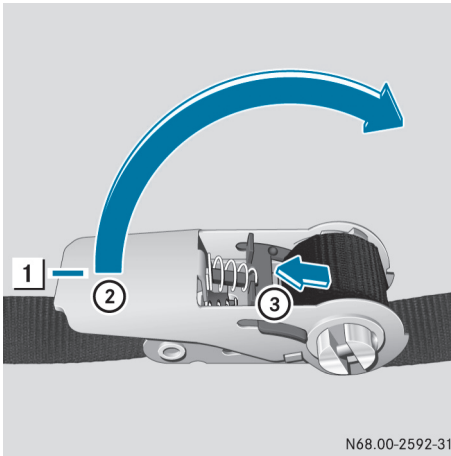

N68.00-2592-31

Tensioning lever fastened in detent position

Always observe the operating instructions or the notes of the manufacturer for the operation of the ratchet strap.

- ▶ **To release the tensioning lever:** press stop slider (3) outwards in the direction of the arrow and swing tensioning lever (2) from detent position (1) to the desired position.
- ▶ **To tighten the ratchet strap:** release tensioning lever (2) and open it.

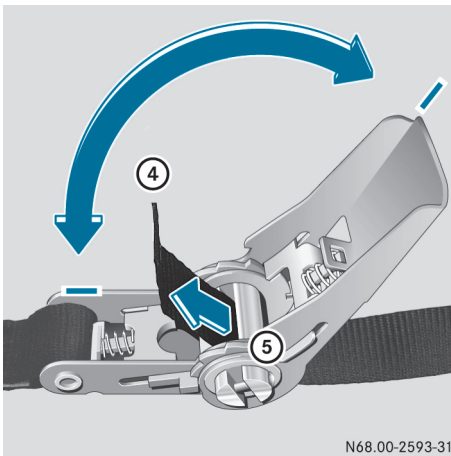

N68.00-2593-31

Threading and tensioning

- ▶ Guide ratchet strap (4) through slotted shaft (5) from behind as illustrated and tighten it.
- ▶ Swing tensioning lever (2) back and forth until the ratchet strap has wound around slotted shaft (5) two to three times.
- ▶ Press stop slider (3) outwards in the direction of the arrow and swing tensioning lever (2) to detent position (1).
- ▶ Release stop slider (3).
The ratchet is closed and engaged.

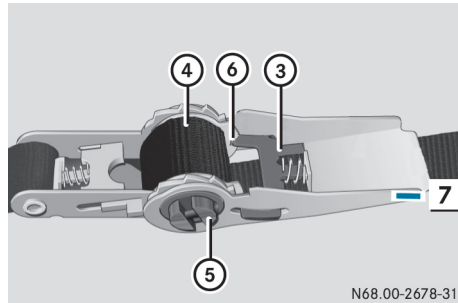

N68.00-2678-31

Tensioning lever in the release position

- ▶ **To release the ratchet strap:** release tensioning lever (2) and swing it into release position (7).
Lock stop slider (3) engages in end recess (6) and slotted shaft (5) can move freely.
- ▶ Pull ratchet strap (4) out of the ratchet.

Securing loads

Load protection net

⚠ WARNING

The load protection net alone cannot restrain or secure heavy objects, luggage or heavy loads. In the event of abrupt changes in direction, braking maneuvers or an accident, you may be struck by unsecured loads. There is a risk of injury, possibly even fatal.

Always stow objects in such a way that they cannot be tossed about. Secure objects, luggage and loads to prevent them slipping or tipping over, e.g. by lashing them down, even when using the load protection net.

⚠ WARNING

If vehicle occupants are seated behind a load protection net, they may be squeezed up against the load protection net. There is a risk of injury, particularly in the event of braking maneuvers or abrupt changes in direction. Never allow vehicle occupants to sit behind the load protection net.

The load protection net borders the cargo compartment. It protects vehicle occupants from light objects and/or luggage slipping or tipping over. Always observe the notes on securing loads (▷ page 244).

You can install the load protection net at an angle behind the front seats or behind the first row of back seats.

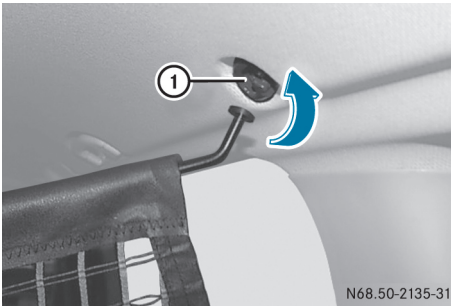

Upper retainer

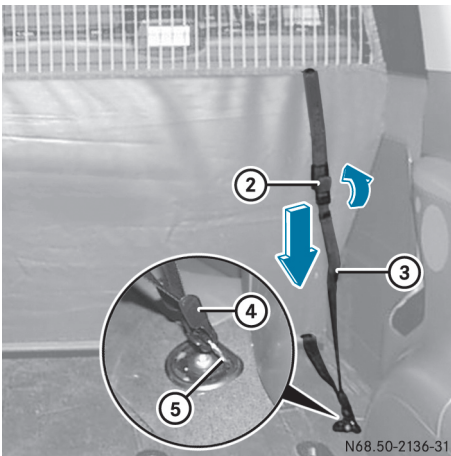

Anchorage (example: fixed cargo tie-down ring)

Installing

- ▶ Clip the load protection net into upper retainers ① in such a way that tensioning straps ③ face the rear of the vehicle.
- ▶ Pull tensioning straps ③ of the load protection net tightly.
- ▶ Clip hook ④ on tensioning straps ③ into cargo tie-down rings ⑤.
- ▶ Fold tensioning element ② up.
- ▶ Pull the loose ends of tensioning straps ③ down in the direction of the arrow until tensioning straps ③ are tight.
- ▶ Fold tensioning element ② down to achieve the final tension on the straps.
- ▶ After traveling a short distance, check that the load protection net is taut.
- ▶ Retighten, if necessary.

Removing

- ▶ Fold tensioning element ② up. Tensioning straps ③ are slack.
- ▶ Unclip hook ④ of tensioning straps ③ from cargo tie-down rings ⑤ at the bottom.
- ▶ Unclip the load protection net from upper retainers ①.
- ▶ Roll up the load protection net and fasten it, still rolled up, using the Velcro fasteners.

Adjusting the front seat with the load protection net installed

- ▶ Fold tensioning element ② on straps ③ upwards. The load protection net slackens.
- ▶ Correctly adjust the front seat.
- ▶ Re-tension the load protection net.

Carrier systems**⚠ WARNING**

When you load the roof, the center of gravity of the vehicle rises and the driving characteristics change. If you exceed the maximum roof load, the driving characteristics, as well as steering and braking, will be greatly impaired. There is a risk of an accident.

Never exceed the maximum roof load and adjust your driving style.

You will find information about the maximum roof load under "Cargo tie-down points and carrier systems" (> page 312).

! Make sure that:

- the screws of the roof carrier are tightened to a maximum torque of 7.4 lb-ft (10 Nm) in the threaded holes provided and
- there is a minimum bolt penetration of 4 turns.

Only install roof carriers and rear racks that have been approved or recommended for Mercedes-Benz vehicles. This will help avoid damage to the vehicle.

You can install a roof carrier on the roof and, for example, a rear-mounted cycle rack on the tailgate.

Install the protective caps on the securing threads after you have removed the roof carrier.

If you have installed a rear rack on the tailgate, the additional weight reduces the assistance provided by the gas pressure springs when the tailgate is opened. You will then need more force to open the tailgate. At low outside temperatures below freezing you will need to provide extra support for the tailgate to prevent it from sinking unintentionally.

Useful information

This Operator's Manual describes all models as well as standard and optional equipment of your vehicle that were available at the time of going to print. Country-specific variations are possible. Note that your vehicle may not be equipped with all of the described functions. This also applies to systems and functions relevant to safety.

Read the information on qualified specialist workshops (▷ page 31).

Engine compartment

Hood

Maintenance and care

Important safety notes

WARNING

If the hood is unlatched, it may open up when the vehicle is in motion and block your view. There is a risk of an accident.

Never unlatch the hood while driving. Before every trip, ensure that the hood is locked.

WARNING

Opening the hood when the engine is overheated or when there is a fire in the engine compartment could expose you to hot gases or other service products. There is a risk of injury.

Let an overheated engine cool down before opening the hood. If there is a fire in the engine compartment, keep the hood closed and contact the fire department.

WARNING

The engine compartment contains moving components. Certain components, such as the radiator fan, may continue to run or start again suddenly when the ignition is off. There is a risk of injury.

If you need to do any work inside the engine compartment:

- switch off the ignition
- never reach into the area where there is a risk of danger from moving components, such as the fan rotation area
- remove jewelry and watches
- keep items of clothing and hair, for example, away from moving parts

WARNING

The ignition system operates with a high voltage. If you touch the live components, you could receive an electric shock. There is an increased risk of injury.

Never touch components of the ignition system if:

- the engine is running or being started
- the key is in radio position or drive position in the ignition lock

The live components of the ignition system are, for example:

- ignition coils
- spark plug connectors
- diagnostic sockets

WARNING

Certain components in the engine compartment, such as the engine, radiator and parts of the exhaust system, can become very hot. Working in the engine compartment poses a risk of injury.

Where possible, let the engine cool down and touch only the components described in the following.

If you have to carry out work in the engine compartment, only touch the following components:

- hood
- oil dipstick
- engine oil filler neck cap
- washer fluid reservoir cap
- coolant expansion tank cap

Opening the hood

⚠ WARNING

Opening the hood when the engine is overheated or when there is a fire in the engine compartment could expose you to hot gases or other service products. There is a risk of injury.

Let an overheated engine cool down before opening the hood. If there is a fire in the engine compartment, keep the hood closed and contact the fire department.

⚠ WARNING

Certain components in the engine compartment, such as the engine, radiator and parts of the exhaust system, can become very hot. Working in the engine compartment poses a risk of injury.

Where possible, let the engine cool down and touch only the components described in the following.

! Make sure that the windshield wipers are not folded away from the windshield. You could otherwise damage the windshield wipers or the hood.

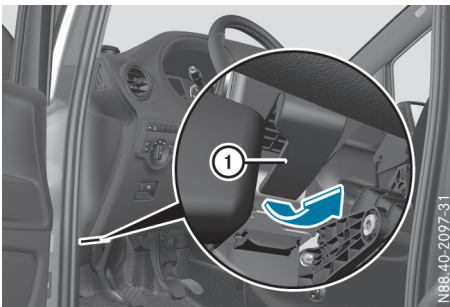

Observe the safety notes when you open the hood.

- ▶ Stop your vehicle as far away from traffic as possible on level ground.
- ▶ Switch off the engine.
- ▶ Secure the vehicle to prevent it from rolling away (▷ page 133).
- ▶ Pull release handle ① on the hood. The hood is released.

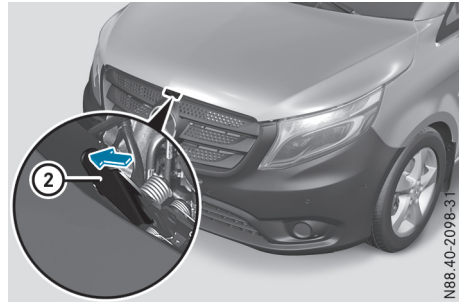

- ▶ Reach into the gap and push lever ② on the hood catch to the left.
- ▶ Raise the hood and hold it in that position.

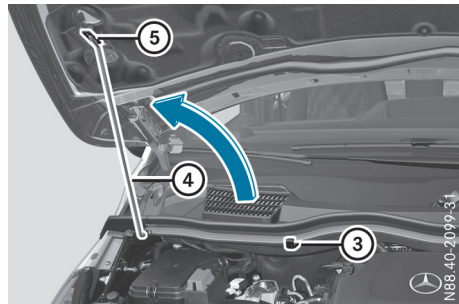

- ▶ Pull support strut ④ out of retainer ③ and guide it up in the direction of the arrow.
- ▶ Lower the hood in such a way that support strut ④ glides into recess ⑤ and the hood engages.

Closing the hood

⚠ WARNING

Cloths or other flammable materials left in the engine compartment can ignite if they come into contact with the exhaust system or parts of the engine that heat up. There is a risk of fire. After carrying out maintenance work, make sure that no extraneous flammable material is left in the engine compartment or on the exhaust system.

! Do not use your hands to push the hood down. You could damage it otherwise.

- ▶ Hold support strut ④ and lift the hood slightly.
- ▶ Guide support strut ④ towards retainer ③ and apply slight pressure to make it engage.
- ▶ Lower the hood and allow it to fall with momentum from a height of approximately 1 ft (30 cm).
The hood locks audibly.
- ▶ Check that the hood is correctly locked. If the hood can be raised slightly, it is not properly engaged. If the hood is not correctly engaged, open the hood again. Let the hood fall with a little more momentum.

Overview of the engine compartment

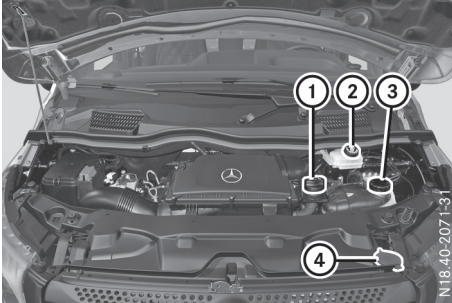

Engine compartment (example)

- ① Engine oil filler neck cap (▷ page 252)
- ② Brake fluid reservoir cap (▷ page 255)
- ③ Coolant expansion tank cap (▷ page 253)
- ④ Washer fluid reservoir cap (▷ page 256)

Regularly check the fluid level and the assembly for leaks. If you detect fluid loss, e.g. oil stains on the vehicle parking space, consult a qualified specialist workshop immediately.

Engine oil

General notes

- ❗ Engine oil gets dirty in the course of operation and its quality and volume are gradually diminished. Regularly check the oil level, and top up or have it replaced as needed.

Observe the information on approved engine oils and oil consumption under "Service products and capacities" (▷ page 307).

You can check the oil level in the engine:

- with the oil dipstick

Checking the oil level using the oil dipstick

⚠ WARNING

Opening the hood when the engine is overheated or when there is a fire in the engine compartment could expose you to hot gases or other service products. There is a risk of injury.

Let an overheated engine cool down before opening the hood. If there is a fire in the engine compartment, keep the hood closed and contact the fire department.

⚠ WARNING

Certain components in the engine compartment, such as the engine, radiator and parts of the exhaust system, can become very hot. Working in the engine compartment poses a risk of injury.

Where possible, let the engine cool down and touch only the components described in the following.

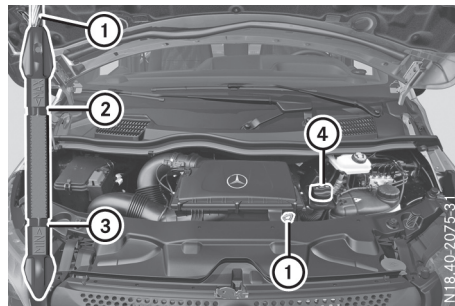

Oil dipstick and engine oil filler neck

Only check the oil level when the engine is at normal operating temperature.

- ▶ Stop your vehicle as far away from traffic as possible on level ground.
- ▶ Secure the vehicle to prevent it from rolling away.
- ▶ Switch off the engine.
- ▶ Wait for five minutes.

- ▶ Open the hood (▷ page 251).
- ▶ Pull out oil dipstick ①.
- ▶ Wipe oil dipstick ① using a lint-free cloth.
- ▶ Insert oil dipstick ① back into the guide tube as far as it will go and remove it again.
If the level is between MIN mark ③ and MAX mark ②, the oil level is adequate.
- ▶ If the oil level has dropped to or below minimum mark ③, open cap ④ and add engine oil (▷ page 253).
The difference in quantity between marks ② and ③ is approximately 2 US quarts (2 liters).
- ▶ Close the hood.

Adding engine oil

WARNING

Opening the hood when the engine is overheated or when there is a fire in the engine compartment could expose you to hot gases or other service products. There is a risk of injury.

Let an overheated engine cool down before opening the hood. If there is a fire in the engine compartment, keep the hood closed and contact the fire department.

WARNING

Certain components in the engine compartment, such as the engine, radiator and parts of the exhaust system, can become very hot. Working in the engine compartment poses a risk of injury.

Where possible, let the engine cool down and touch only the components described in the following.

WARNING

If engine oil comes into contact with hot components in the engine compartment, it may ignite. There is a risk of fire and injury.

Make sure that engine oil is not spilled next to the filler neck. Let the engine cool down and thoroughly clean the engine oil off the components before starting the engine.

Environmental note

When adding oil, take care not to spill any. If oil enters the soil or waterways, it is harmful to the environment.

 Do not add too much oil. Adding too much engine oil can result in damage to the engine or to the catalytic converter. Have excess engine oil siphoned off.

 Do not use any additives in the engine oil. This could damage the engine.

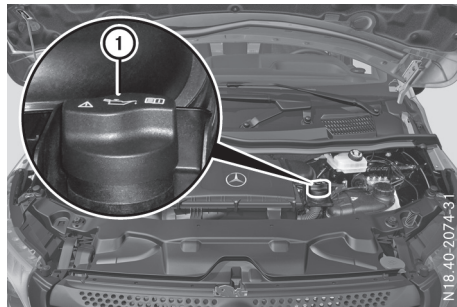

Engine oil filler neck (example)

Observe the information regarding approved motor oil under "Service products and capacities" (▷ page 307).

- ▶ Open the hood (▷ page 251).
- ▶ Unscrew and remove cap ①.
- ▶ Add engine oil.
- ▶ Replace cap ① on the filler neck and tighten. When doing so, make sure that the cap engages correctly.
- ▶ Check the oil level with the oil dipstick (▷ page 252).
- ▶ Close the hood.

Coolant

WARNING

Service products may be poisonous and hazardous to health. There is a risk of injury.

Comply with instructions on the use, storage and disposal of service products on the labels of the respective original containers. Always store service products sealed in their original

containers. Always keep service products out of the reach of children.

WARNING

Opening the hood when the engine is overheated or when there is a fire in the engine compartment could expose you to hot gases or other service products. There is a risk of injury.

Let an overheated engine cool down before opening the hood. If there is a fire in the engine compartment, keep the hood closed and contact the fire department.

WARNING

Certain components in the engine compartment, such as the engine, radiator and parts of the exhaust system, can become very hot. Working in the engine compartment poses a risk of injury.

Where possible, let the engine cool down and touch only the components described in the following.

Coolant contains glycol and is therefore poisonous. Also observe the safety notes under "Service products and capacities" (▷ page 304).

WARNING

The cooling system is pressurized, particularly when the motor is warm. If you open the cap, you could be scalded if hot coolant sprays out. There is a risk of injury.

Let the engine cool down before you open the cap. Wear gloves and eye protection. Slowly open the cap to relieve pressure.

Only check the coolant level and/or fill the coolant if the vehicle is on a level surface and the engine has cooled down. The coolant temperature must be below 122 °F (50 °C).

 Check the engine cooling and heating system regularly for leaks.

If a large quantity of coolant is lost, have the cause traced and rectified at a qualified specialist workshop.

WARNING

If antifreeze comes into contact with hot components in the engine compartment, it may ignite. There is a risk of fire and injury.

Let the engine cool down before you add antifreeze. Make sure that antifreeze is not spilled next to the filler neck. Thoroughly clean the antifreeze from components before starting the engine.

 Take care not to spill any coolant on painted surfaces. You could otherwise damage the paintwork.

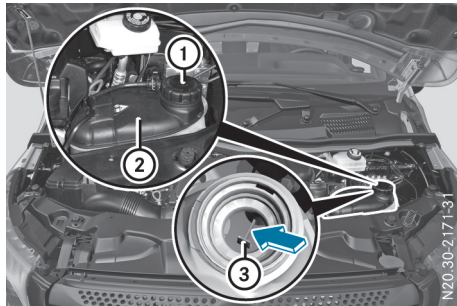

Example: cap and coolant expansion tank
Checking the coolant level

- ▶ Stop your vehicle as far away from traffic as possible on level ground.
- ▶ Switch off the engine.
- ▶ Secure the vehicle to prevent it from rolling away.
- ▶ Open the hood (▷ page 251).
- ▶ Allow the engine to cool down.
- ▶ Unscrew cap ① slowly about half a turn counter-clockwise and allow excess pressure to escape.
- ▶ Turn cap ① further and remove it from coolant expansion tank ②.
- ▶ Check the coolant level.
 - If the coolant is up to marker bar ③ in the filler neck when cold, there is a sufficient amount of coolant in coolant expansion tank ②.
 - If the coolant is approximately 0.59 in (1.5 cm) above marker bar ③ in the filler neck when warm, there is a sufficient amount of coolant in coolant expansion tank ②.

Adding coolant

- ▶ If the coolant drops under marker bar ③ in the filler neck, add coolant. Observe the information on the correct coolant mixture ratio and the required water quality under "Service products and capacities" (> page 309). To prevent damage to the engine cooling system, use only approved corrosion inhibitor/antifreeze that complies with the Mercedes-Benz Specifications for Service Products.
- ▶ Replace cap ① and tighten in a clockwise direction.
- ▶ Start the engine.
- ▶ Set the temperature in the vehicle interior to the maximum output on the air-conditioning system control panel.
- ▶ After approximately five minutes, switch off the engine again and allow it to cool down.
- ▶ Check the coolant level again and add coolant if necessary.
- ▶ Close the hood.

Brake fluid

 **WARNING**

Service products may be poisonous and hazardous to health. There is a risk of injury.

Comply with instructions on the use, storage and disposal of service products on the labels of the respective original containers. Always store service products sealed in their original containers. Always keep service products out of the reach of children.

 **WARNING**

Opening the hood when the engine is overheated or when there is a fire in the engine compartment could expose you to hot gases or other service products. There is a risk of injury.

Let an overheated engine cool down before opening the hood. If there is a fire in the engine compartment, keep the hood closed and contact the fire department.

 **WARNING**

Certain components in the engine compartment, such as the engine, radiator and parts of the exhaust system, can become very hot. Working in the engine compartment poses a risk of injury.

Where possible, let the engine cool down and touch only the components described in the following.

Brake fluid is hazardous to health. Also observe the safety notes under "Service products and capacities" (> page 304).

 **WARNING**

The brake fluid constantly absorbs moisture from the air. This lowers the boiling point of the brake fluid. If the boiling point of the brake fluid is too low, vapor pockets may form in the brake system when the brakes are applied hard. This would impair braking efficiency. There is a risk of an accident.

You should have the brake fluid renewed at the specified intervals.

 If the brake fluid level in the brake fluid reservoir has fallen to the MIN mark or below, check the brake system immediately for leaks. Also check the thickness of the brake linings. Visit a qualified specialist workshop immediately.

Do not add brake fluid. This does not correct the malfunction.

 Brake fluid corrodes paint, plastic and rubber. If paint, plastic or rubber has come into contact with brake fluid, rinse with water immediately.

Have the brake fluid renewed every two years at a qualified specialist workshop. Observe the information regarding brake fluid in the "Service products and capacities" section (> page 309).

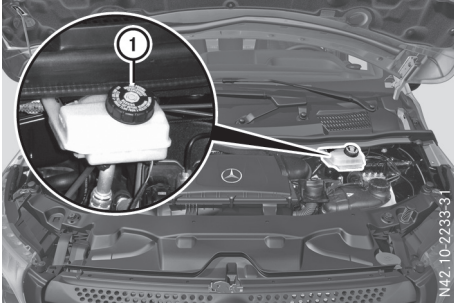

Check the brake fluid level regularly, e.g. weekly or when refueling.

Checking the brake fluid level

- ▶ Stop your vehicle as far away from traffic as possible on level ground.
- ▶ Switch off the engine.
- ▶ Secure the vehicle to prevent it from rolling away.
- ▶ Open the hood (▷ page 251).
- ▶ Check the brake fluid level.
The brake fluid level is adequate if the level is between the MIN mark and MAX mark on brake fluid reservoir ①.
- ▶ Close the hood.

Washer fluid

WARNING

Opening the hood when the engine is overheated or when there is a fire in the engine compartment could expose you to hot gases or other service products. There is a risk of injury.

Let an overheated engine cool down before opening the hood. If there is a fire in the engine compartment, keep the hood closed and contact the fire department.

WARNING

Certain components in the engine compartment, such as the engine, radiator and parts of the exhaust system, can become very hot. Working in the engine compartment poses a risk of injury.

Where possible, let the engine cool down and touch only the components described in the following.

WARNING

Windshield washer concentrate could ignite if it comes into contact with hot engine components or the exhaust system. There is a risk of fire and injury.

Make sure that no windshield washer concentrate is spilled next to the filler neck.

- ❗ Only use washer fluid that is suitable for plastic lamp lenses, e.g. MB SummerFit or MB WinterFit. Unsuitable washer fluid could damage the plastic lenses of the headlamps.

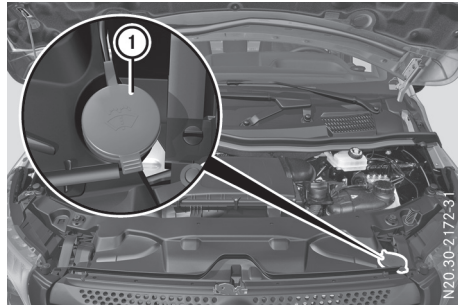

Example: washer fluid reservoir

Add windshield washer concentrate to the washer fluid all year round. Observe the information regarding washer fluid under "Service Products and Capacities" (▷ page 311).

Adding washer fluid

- ▶ Mix the washer fluid to the appropriate mixing ratio in a container beforehand.
- ▶ Open the hood (▷ page 251).
- ▶ Pull cap ① on the washer fluid reservoir upwards at the tab.
- ▶ Add the premixed washer fluid.
- ▶ Press cap ① onto the filler neck until it engages audibly.
- ▶ Close the hood.

Maintenance

General notes

Environmental note

Observe measures to protect the environment when working on the vehicle. You must observe the legal requirements when disposing of service products, e.g. engine oil. This also includes all components, e.g. filters, which have come into contact with service products. Any qualified specialist workshop can provide information about this.

Dispose of empty containers, cleaning cloths and care products in an environmentally responsible manner. Comply with the instructions for use of the care products.

Do not run the engine for longer than necessary when the vehicle is stationary.

Before carrying out maintenance measures and repairs, you must read the following documents relating to maintenance measures and repairs:

- relevant sections of the technical documentation such as the Operator's Manual and workshop information
- legal stipulations such as work safety regulations and accident prevention regulations

While working under the vehicle, you must secure the vehicle on jack stands with sufficient load capacity.

Never use a vehicle jack instead of stands. The jack is designed only to raise the vehicle for a short time when changing a wheel. It is not suited for performing maintenance work under the vehicle.

Please also refer to the notes about qualified specialist workshops (▷ page 31).

The scope and regularity of the inspection and maintenance work primarily depend on the often diverse operating conditions. Specialist knowledge beyond the scope of this Operator's Manual is required when carrying out testing and maintenance work. This work should only be carried out by trained staff.

The vehicle Maintenance Booklet describes the scope and frequency of maintenance work and contains additional notes on the Limited Warranty. You will find information about service products approved by Mercedes-Benz and

capacities under "Service products and capacities" (▷ page 304)

Maintenance services must be carried out in accordance with the provisions and recommendations in the Maintenance Booklet. Not doing so could void the warranty claim and lead to refusal of goodwill gestures after the manufacturer has submitted a damage report.

Observe the information under "Mercedes-Benz genuine parts" (▷ page 33).

Service interval display

General notes

The service interval display informs you of the next service due date. Information on the type of service and service intervals can be found in the Maintenance Booklet.

 The service interval display does not provide information about the engine oil level. The service interval display should therefore not be confused with the engine oil level display.

For example, the display shows one of the following service messages for a few seconds:

- **Service A in .. days**
- **Service A Due** or **Service A Due**
- **Serv. A Exceed. by .. Days**

Then either the remaining time or distance until the next service due date is displayed. If the service due date has been exceeded, the elapsed time or distance traveled after the overdue service date is shown. The letter in the display message indicates which service is due. **A** stands for a minor service and **B** for a major service.

A qualified specialist workshop, e.g. an authorized Mercedes-Benz Commercial Van Center, will reset the service interval display after the service work has been carried out. You can also obtain further information on maintenance work, for example.

The prescribed service interval is based on normal vehicle use. Service work will need to be performed more frequently than prescribed if the vehicle is operated under more arduous conditions or with higher loads. Such arduous conditions include:

- regular city driving with frequent intermediate stops
- driving predominantly short distances

- frequent operation in mountainous terrain or on poor road surfaces
- leaving the engine idling for long periods on a frequent basis

In these or similar operating conditions, have the air filter, engine oil and oil filter, for example, replaced more frequently. Under more arduous operating conditions, the tires must be checked more often. Further information can be obtained at a qualified specialist workshop, e.g. an authorized Mercedes-Benz Commercial Van Center.

Hiding service messages

Vehicles without steering wheel buttons

- ▶ Press the **(R)** button on the instrument cluster.

Vehicles with steering wheel buttons

- ▶ Press the **[OK]** or **[←]** button on the steering wheel.

Calling up the service due date

Vehicles without steering wheel buttons

The vehicle must be stationary. Use the buttons in the instrument cluster.

- ▶ Turn the SmartKey to position **2** in the ignition lock.
- ▶ Press **(⊕)** to select the service display. The display shows a possible service message.

Vehicles with steering wheel buttons

Using the steering wheel buttons

- ▶ Turn the SmartKey to position **2** in the ignition lock.
- ▶ Press **[←]** or **[→]** to select the **Service** menu.
- ▶ Press **[▲]** or **[▼]** to select the **ASSYST PLUS** submenu and press **[OK]** to confirm. The display shows the service due date.

Battery

Important safety notes

Work on the battery, e.g. removing or installing, requires specialist knowledge and the use of special tools. Therefore, always have work on

the battery carried out at a qualified specialist workshop.

WARNING

Work carried out incorrectly on the battery can lead, for example, to a short circuit and thus damage the vehicle electronics. This can lead to function restrictions applying to safety-relevant systems, e.g. the lighting system, the ABS (anti-lock braking system) or the ESP® (Electronic Stability Program). The operating safety of your vehicle may be restricted.

You could lose control of the vehicle, for example:

- when braking
- in the event of abrupt steering maneuvers and/or when the vehicle's speed is not adapted to the road conditions

There is a risk of an accident.

In the event of a short circuit or a similar incident, contact a qualified specialist workshop immediately. Do not drive any further. You should have all work involving the battery carried out at a qualified specialist workshop.

Further information can be found under "ABS" (> page 64) and under "ESP®" (> page 65).

WARNING

Electrostatic build-up can lead to the creation of sparks, which could ignite the highly explosive gases of a battery. There is a risk of an explosion.

Before handling the battery, touch the vehicle body to remove any existing electrostatic build-up.

The flammable gas mix is produced when the battery is charged or when the vehicle is jump-started.

Always make sure that neither you nor the battery are electro statically charged. Electrostatic charging results, for example, from:

- wearing synthetic clothing
- friction between clothing and the seat
- dragging or pushing the battery across carpet flooring or any other synthetic materials
- rubbing the battery with cloths or towels.

Comply with the following safety precautions and take protective measures when handling batteries.



Risk of explosion. Explosive oxyhydrogen is produced when batteries are being charged. Only charge batteries in well-ventilated areas.



Fire, open flames and smoking are therefore prohibited when working on the battery. Avoid creating sparks.



Battery acid is caustic. Avoid contact with the skin, eyes or clothing. Wear acid-proof protective gloves. If skin or clothes are splashed with acid, neutralize the splashes immediately with soapy water or an acid neutralizer, and then clean the affected areas with water. Consult a doctor if necessary.



Wear eye protection. When mixing water and acid, the liquid can splash into your eyes. Rinse acid splashes to the eyes immediately with clean water and contact a doctor immediately.



Keep children at a safe distance. Children are not able to assess the dangers posed by batteries and acid.



When handling batteries, observe the safety precautions and special protective measures contained in this Operator's Manual.



Environmental note



Batteries contain dangerous substances. It is against the law to dispose of them with the household rubbish. They must be collected separately and recycled to protect the environment.



Dispose of batteries in an environmentally friendly manner. Take discharged batteries to a qualified specialist workshop or a special collection point for used batteries.

Observe the following notes:

- Recharge the battery more frequently, if you:
 - predominantly drive short distances
 - predominantly drive at low outside temperatures
 - leave the vehicle parked for a lengthy period

In order for the batteries to achieve their maximum possible service life, they must always be sufficiently charged.

- Consult an authorized Mercedes-Benz Commercial Van Center if you wish to leave your vehicle parked for a long period of time.
- When you park the vehicle, remove the key if you do not require any electrical consumers. The vehicle will then use very little energy, thus conserving battery power.
- If your vehicle requires jump-starting, or if you wish to provide jump-starting assistance to another vehicle, only use the jump-starting connection point in the engine compartment (> page 272).
- Have the battery removed at a qualified specialist workshop.

Installation locations

Your vehicle may be equipped with three batteries, depending on the equipment version:

- Starter battery in the seat base of the right-hand front seat
- Auxiliary battery in the seat base of the right-hand front seat
- Additional battery in the seat base of the left-hand front seat

Disconnecting and removing

WARNING

During the charging process, a battery produces hydrogen gas. If a short circuit occurs or sparks are created, the hydrogen gas can ignite. There is a risk of an explosion.

- Make sure that the positive terminal of a connected battery does not come into contact with vehicle parts.
- Never place metal objects or tools on a battery.

- It is important that you observe the described order of the battery terminals when connecting and disconnecting a battery.
- When jump-starting, make sure that the battery poles with identical polarity are connected.
- It is particularly important to observe the described order when connecting and disconnecting the jumper cables.
- Never connect or disconnect the battery terminals while the engine is running.

⚠ WARNING

Battery acid is caustic. There is a risk of injury. Avoid contact with skin, eyes or clothing. Do not inhale any battery gases. Do not lean over the battery. Keep children away from batteries. Wash away battery acid immediately with plenty of clean water and seek medical attention.

! You should have all work involving the battery carried out at a qualified specialist workshop.

If, in exceptional circumstances, you need to disconnect the battery yourself, please make sure that:

- Secure the vehicle to prevent it from rolling away.
- You have switched off the engine and removed the key. Make sure the ignition is switched off. Check to see that there are no indicator lamps lighting in the instrument cluster. Electronic components such as the alternator may otherwise be damaged.
- After the battery has been disconnected, the parking brake is automatically engaged. You can then no longer move the vehicle.
- For vehicles with automatic transmission, the transmission is locked in position **P** after disconnecting the battery. You can then no longer move the vehicle.
- You have first removed the negative terminal and then the positive terminal. Never mix up the terminal clamp disconnection/connection order and never mix up the terminal clamps. The vehicle's electronics may otherwise be damaged.

The battery and the cover of the positive terminal clamp must be installed securely during operation.

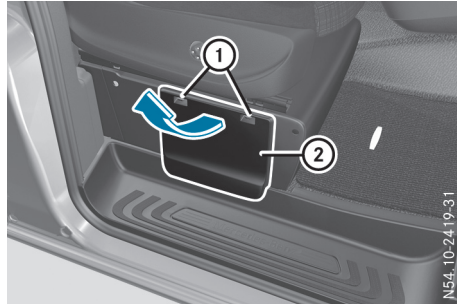

Seat base (example: right-hand front seat)

The following description on disconnecting and removing the battery is based upon the example of the starter battery in the seat base of the driver's seat. The additional battery is disconnected and removed in the same way as the starter battery. The auxiliary battery is located in the seat base of the left-hand front seat.

- ▶ Switch off all electrical consumers.
- ▶ Switch off the engine and remove the key from the ignition lock.
- ▶ Open the front door on the right-hand side.
- ! To disconnect or remove the additional battery, open the left-hand front door. The auxiliary battery is located in the seat base of the left-hand front seat.
- ▶ Press both latching springs ① down and remove cover ② upwards from the seat base.
- ▶ Remove cover ② by pulling upwards at an angle from the seat base.

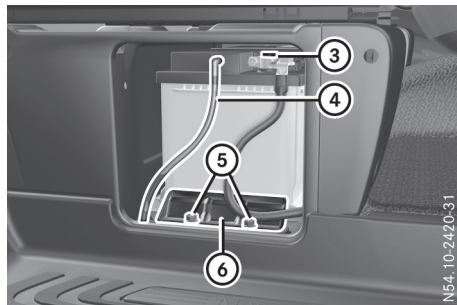

Open seat base (example: right-hand front seat)

- ▶ Remove screws ⑤ from holder ⑥.
- ▶ Remove holder ⑥.

- ▶ Remove breather hose ④ from the top of the battery.
- ▶ Pull the battery out of the seat base until the negative clamp can be released and removed.
- ▶ Disconnect the negative clamp from negative terminal ③.
- ▶ Remove the negative clamp in such a way that the battery cable terminal no longer touches negative terminal ③.

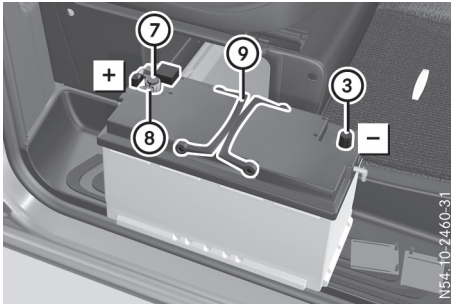

Example: starter battery

- ▶ Remove the battery from the seat base and place it on the door sill panel as shown. If necessary, hold the battery by handles ⑨.
- ▶ Remove the positive clamp cover from positive terminal ⑦.
- ▶ Loosen positive clamp ⑧ on positive terminal ⑦.
- ▶ Remove positive clamp ⑧ in such a way that the battery cable terminal no longer touches positive terminal ⑦.
- ▶ Lift the battery from the door sill panel by handles ⑨.

Reconnecting and installing

WARNING

During the charging process, a battery produces hydrogen gas. If a short circuit occurs or sparks are created, the hydrogen gas can ignite. There is a risk of an explosion.

- Make sure that the positive terminal of a connected battery does not come into contact with vehicle parts.
- Never place metal objects or tools on a battery.

- It is important that you observe the described order of the battery terminals when connecting and disconnecting a battery.
- When jump-starting, make sure that the battery poles with identical polarity are connected.
- It is particularly important to observe the described order when connecting and disconnecting the jumper cables.
- Never connect or disconnect the battery terminals while the engine is running.

! Always connect the battery in the order described below. Never mix up the terminal clamp disconnection/connection order and never mix up the terminal clamps. You may otherwise damage the vehicle electronics.

Always observe the prescribed positive terminal installation position when doing so. Otherwise, the positive clamp may come into contact with vehicle parts. In this case there is a risk that the vehicle may short-circuit and catch fire.

The following description on connecting and installing the battery is based upon the example of the starter battery in the seat base of the right-hand front seat. The additional battery is connected and installed in the same way as the starter battery. The auxiliary battery is located in the seat base of the left-hand front seat.

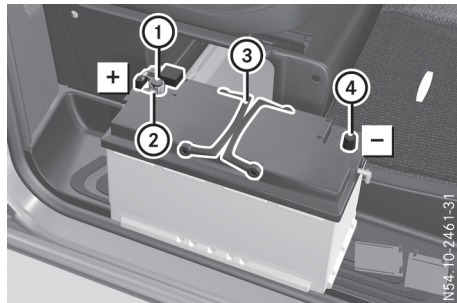

Example: starter battery

- ▶ Place the battery on the door sill panel as shown and secure with handles ③ if necessary.
- ▶ Connect positive clamp ② to positive terminal ①. Always observe the positive terminal installation position shown when doing so. The positive lead must be routed parallel to

the side of the battery housing in the connection area.

- ▶ Place the positive clamp cover on positive terminal ①.
- ▶ Fold both handles ③ down onto the battery.
- ▶ Push the battery into the seat base until the negative terminal can be connected.
- ▶ Connect the negative clamp to negative terminal ④.
- ▶ Push the battery into the seat base as far as it will go.

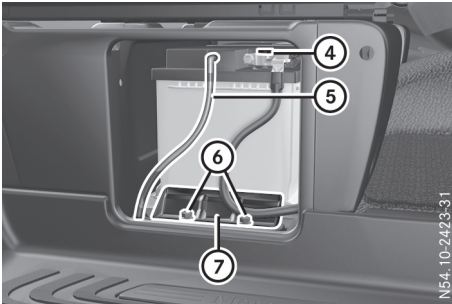

Open seat base with installed battery (example: right-hand front seat)

- ▶ Push breather hose ⑤ onto the battery connection at the top.
- ▶ Guide holder ⑦ over the lower side of the battery housing and the threads for screws ⑥.
- ▶ Screw on holder ⑦ with screws ⑥. The battery is secured to prevent slipping.



Seat base (example: right-hand front seat)

- ▶ Insert cover ⑨ down in front of the battery compartment into the seat base and close it. Latching springs ⑧ of cover ⑨ should engage audibly.

Carry out the following work after connecting the battery:

- ▶ Reset the side window (▷ page 83).
- ▶ Reset the electric sliding doors (▷ page 78).

Charging

⚠ WARNING

A discharged battery can freeze at temperatures below freezing point. When jump-starting the vehicle or charging the battery, gases can escape from the battery. There is a risk of an explosion.

Allow the frozen battery to thaw out before charging it or jump-starting.

If the indicator/warning lamps do not light up in the instrument cluster when temperatures are low, it is probably because the discharged battery has frozen. Should this be the case, do not jump-start the vehicle or charge the battery. The service life of a thawed battery may be shorter. Start-up behavior may deteriorate, in particular at low temperatures. Have the thawed battery checked at a qualified specialist workshop.

⚠ WARNING

During charging and jump-starting, explosive gases can escape from the battery. There is a risk of an explosion.

Particularly avoid fire, open flames, creating sparks and smoking. Ensure there is sufficient ventilation while charging and jump-starting. Do not lean over a battery.

⚠ WARNING

Battery acid is caustic. There is a risk of injury. Avoid contact with skin, eyes or clothing. Do not inhale any battery gases. Do not lean over the battery. Keep children away from batteries. Wash away battery acid immediately with plenty of clean water and seek medical attention.

- ❗ Only charge the installed battery with a battery charger that has been tested and approved by Mercedes-Benz. This device allows the battery to be charged when it is

installed in the vehicle. The vehicle's electronics system may otherwise be damaged.

- ❗ Only charge the battery using the jump-starting connection point.

A battery charger unit specially adapted for Mercedes-Benz vehicles and tested and approved by Mercedes-Benz is available as an accessory. Only this device permits the charging of the battery in its installed position. Contact an authorized Mercedes-Benz Commercial Van Center for information and availability. Read the operating instructions for your charger before charging the battery.

Recharge the battery more frequently if you use the vehicle mainly for short trips and/or drive at low outside temperatures.

Only charge the installed battery with a battery charger that has been tested and approved by Mercedes-Benz, using the jump-start connection point in the engine compartment.

- ▶ Connect the battery charger to the positive terminal and ground terminal in the same order as when connecting the donor battery in the jump-starting procedure (▷ page 272).

- ❗ If a battery is not installed and not in service, you should charge it every three months. This will counter self-discharging and prevent battery damage.

Care

- ❗ Dirty battery clamps and battery surfaces cause leak currents which lead to the batteries discharging.

- ❗ Do not use cleaning agents containing fuel. Cleaning agents containing fuel corrode the battery housing.

- ❗ If dirt gets into the battery cell, battery self-discharge will increase and the battery may be damaged.

The following points on battery care must be observed:

- ▶ Regularly check the battery terminals and the fastening of the negative cable to the chassis to ensure that they are firmly seated.
- ▶ Always keep the battery terminals and battery surfaces clean and dry.

- ▶ Lightly grease the undersides of the battery terminals with acid-resistant grease.
- ▶ Only clean the battery casing with a commercially available cleaning product.

Care

Notes on care

⚠ WARNING

If you use openings in the bodywork or detachable parts as steps, you could:

- slip and/or fall
- damage the vehicle and cause yourself to fall.

There is a risk of injury.

Always use secure climbing aids, e.g. a suitable ladder.

- ❗ Do not use the lower sliding door guide (carriage) as a step. Otherwise, you could damage the paneling and/or the sliding door mechanism.

- ❗ For cleaning your vehicle, do not use any of the following:

- dry, rough or hard cloths
- abrasive cleaning agents
- solvents
- cleaning agents containing solvents

Do not scrub.

Do not touch the surfaces or protective films with hard objects, e.g. a ring or ice scraper. You could otherwise scratch or damage the surfaces and protective film.

- ❗ Do not park your vehicle for a long period of time directly after cleaning, particularly after cleaning the wheel rim with wheel cleaner. Wheel cleaner can lead to the increased corrosion of the brake discs and pads. Therefore, drive for a few minutes after cleaning. By heating up the brakes, the brake discs and pads dry. The vehicle can then be parked for a long period of time.

🌿 Environmental note

Only clean your vehicle at specially designed wash bays. Dispose of empty containers and

used cleaning products in an environmentally responsible manner.

Environmental note

Dispose of empty packaging and cleaning cloths in an environmentally responsible manner.

Regular care of your vehicle is a condition for retaining the quality in the long term.

Use care products and cleaning agents recommended and approved by Mercedes-Benz.

Washing the vehicle and cleaning the paintwork

Automatic car wash

WARNING

Braking efficiency is reduced after washing the vehicle. There is a risk of an accident.

After the vehicle has been washed, brake carefully while paying attention to the traffic conditions until full braking power is restored.

! Make sure that the automatic car wash is suitable for the size of the vehicle.

Before washing the vehicle in an automatic car wash, fold in the exterior mirrors and remove any additional antennas. Otherwise, the exterior mirror, antenna or the vehicle itself could be damaged.

Make sure that the exterior mirrors are fully folded out again and that any additional antennas are re-installed when you leave the automatic car wash.

! Make sure that:

- the side windows and the roof are completely closed
- the climate control blower is switched off
- the windshield wiper switch is at position **O**

The vehicle could otherwise be damaged.

You can wash the vehicle in an automatic car wash from the very start.

Wash off excess dirt before cleaning the vehicle in an automatic car wash.

After putting the vehicle through an automatic car wash, wipe off wax from:

- the windshield
 - the windshield wiper blades
- This will prevent smears and reduce wiping noises caused by residue on the windshield.
- on vehicles with rear doors, from the rear view camera lens in the top of the license plate molding (▷ page 267)

Washing by hand

In some countries, washing by hand is only allowed at specially equipped washing bays. Observe the legal requirements of the country you are currently in when washing by hand.

- ▶ Do not use hot water and do not wash the vehicle in direct sunlight.
- ▶ Use a soft car sponge.
- ▶ Use a mild cleaning agent, e.g. a Mercedes-Benz approved car shampoo.
- ▶ Thoroughly hose down the vehicle with a gentle jet of water.
- ▶ Do not point the water jet directly towards the air inlet grilles.
- ▶ Use plenty of water and rinse out the sponge frequently.
- ▶ Rinse the vehicle with clean water and dry thoroughly with a chamois.
- ▶ Do not let the cleaning agents dry on the paintwork.

When using the vehicle in winter, remove all traces of road salt deposits carefully and as soon as possible.

Power washers

WARNING

The water jet from a circular jet nozzle (dirt blasters) can cause invisible exterior damage to the tires or chassis components. Components damaged in this way may fail unexpectedly. There is a risk of an accident.

Do not use power washers with circular jet nozzles to clean the vehicle. Have damaged tires or chassis components replaced immediately.

! Under no circumstances use power washers in the vehicle interior. The pressurized water

and associated spray produced by the power washer could cause extensive damage to the vehicle.

! When using high-pressure cleaning equipment, maintain a minimum distance of approx. 1 ft (30 cm) between the spray nozzle and the vehicle parts. Do not use a power washer with a round-jet nozzle. You could damage the vehicle or engine parts.

! Keep the water jet moving constantly while cleaning. This will avoid causing damage to the vehicle.

Do not point the water jet at:

- door joints
- rear view camera
- air bellows
- brake hoses
- wheel balance weights
- electrical components
- electrical connections
- seals
- drive train, especially not at the intermediate bearing of the propeller shaft

Cleaning the engine

! Water must not enter intake or ventilation openings. When cleaning with high pressure water or steam cleaners, the spray must not be aimed directly at electrical components or the terminals of electrical lines.

Preserve the engine after the engine has been cleaned. Protect the belt drive system from exposure to the preservative agent.

Also observe the information under "Power washers" (> page 264).

Cleaning the paintwork

! Do not affix:

- stickers
- films
- magnetic plates or similar items

to painted surfaces. You could otherwise damage the paintwork.

Scratches, corrosive deposits, areas affected by corrosion and damage caused by inadequate care cannot always be completely repaired. In such cases, visit a qualified specialist workshop.

- ▶ Remove impurities immediately, where possible, whilst avoiding rubbing too hard.
- ▶ Soak insect remains with insect remover and rinse off the treated areas afterwards.
- ▶ Soak bird droppings with water and rinse off the treated areas afterwards.
- ▶ Remove coolant, brake fluid, tree resin, oils, fuels and greases by rubbing gently with a cloth soaked in petroleum ether or lighter fluid.
- ▶ Use tar remover to remove tar stains.
- ▶ Use silicone remover to remove wax.

Cleaning the windows

WARNING

You could become trapped by the windshield wipers if they start moving while cleaning the windshield or wiper blades. There is a risk of injury.

Always switch off the windshield wipers and the ignition before cleaning the windshield or wiper blades.

! Do not fold the windshield wipers away from the windshield unless the hood is closed. Otherwise, you could damage the hood.

! Hold the wiper arm securely when folding back. The windshield could be damaged if the wiper arm smacks against it suddenly.

! Do not use dry cloths, abrasive products, solvents or cleaning agents containing solvents to clean the inside of the windows. Do not touch the insides of the windows with hard objects, e.g. an ice scraper or ring. There is otherwise a risk of damaging the windows.

! Clean the water drainage channels of the windshield and the rear window at regular intervals. Deposits such as leaves, petals and pollen may under certain circumstances prevent water from draining away. This can lead to corrosion damage and damage to electronic components.

▶ Clean the inside and outside of the windows with a damp cloth and a cleaning agent that is recommended and approved by Mercedes-Benz.

Exterior

Cleaning the wheels

- ❗ Do not use any acidic or alkaline cleaning agents. They can cause corrosion on the wheel bolts or the retainer springs for the wheel-balancing weights.
- ❗ Do not park your vehicle for a long period of time directly after cleaning, particularly after cleaning the wheel rim with wheel cleaner. Wheel cleaner can lead to the increased corrosion of the brake discs and pads. Therefore, drive for a few minutes after cleaning. By heating up the brakes, the brake discs and pads dry. The vehicle can then be parked for a long period of time.

If you clean the wheels with a power washer, observe the safety notes for the power washer (► page 264). You could otherwise damage the tires.

Cleaning the wiper blades

⚠ WARNING

You could become trapped by the windshield wipers if they start moving while cleaning the windshield or wiper blades. There is a risk of injury.

Always switch off the windshield wipers and the ignition before cleaning the windshield or wiper blades.

- ❗ Do not fold the windshield wipers away from the windshield unless the hood is closed. Otherwise, you could damage the hood.
 - ❗ Do not pull the wiper blade. Otherwise, the wiper blade could be damaged.
 - ❗ Do not clean wiper blades too often and do not rub them too hard. Otherwise, the graphite coating could be damaged. This could cause wiper noise.
 - ❗ Hold the wiper arm securely when folding back. The windshield could be damaged if the wiper arm smacks against it suddenly.
- ▶ Turn the SmartKey to position **0** in the ignition lock or remove the SmartKey.
 - ▶ Fold the windshield wiper arms away from the windshield until you feel them engage.

- ▶ Carefully clean the wiper blades with a damp cloth.
- ▶ Fold back the wiper arms before switching on the ignition.

Cleaning the exterior lighting

- ❗ Only use cleaning agents or cleaning cloths which are suitable for plastic light lenses. Unsuitable cleaning agents or cleaning cloths could scratch or damage the plastic light lenses.
- ▶ Clean the plastic covers of the exterior lighting with a damp sponge and a mild cleaning agent, e.g. Mercedes-Benz car shampoo, or with cleaning cloths.

Cleaning the sensors

- ❗ Do not use dry, coarse or hard cloths and do not scrub. You will otherwise scratch or damage the sensors.

If you clean the sensors with a power washer or steam cleaner, observe the information provided by the manufacturer regarding the distance to be maintained between the vehicle and the nozzle of the power washer.

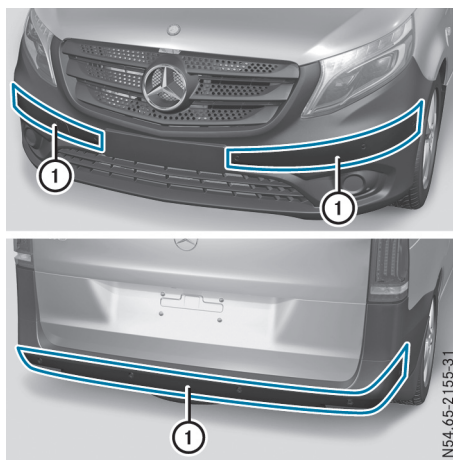

- ▶ Clean drive system sensors ① with water, car shampoo and a soft cloth.

Cleaning the rear view camera

! Do not use dry, coarse or hard cloths and do not scrub. You could otherwise scratch or damage the lens of the rear view camera.

When cleaning the vehicle with a high-pressure or steam cleaner, observe a minimum distance of 1.6 ft (50 cm) to the rear view camera. Do not aim directly at the rear view camera. You could otherwise damage the rear view camera.

Make sure that you do not apply any wax to camera lens when waxing the vehicle. If necessary, remove the wax using water, shampoo and a soft cloth.

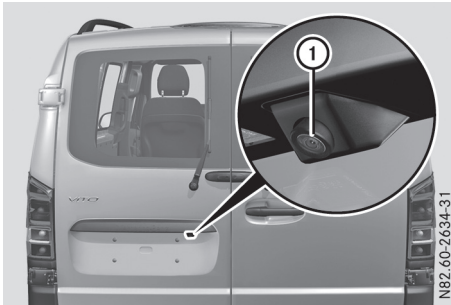

Vehicles with rear doors

- ▶ Clean camera lens ① with clean water and a soft cloth.

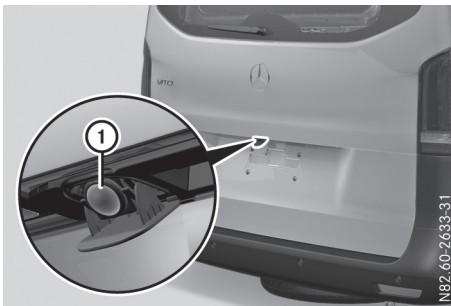

Vehicles with a tailgate

- ▶ Make sure that the engine is switched off and the key is in position **2** in the ignition lock.
- ▶ Engage reverse gear or shift the transmission to position **R**.
The rear view camera flap opens.
- ▶ Clean camera lens ① with clean water and a soft cloth.

Cleaning the sliding door

The care instructions do not apply to electric sliding doors.

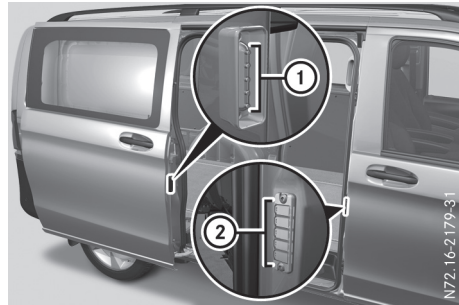

- ▶ Remove foreign objects from the vicinity of contact surfaces ② and contact pins ① of the sliding door.
- ▶ Clean contact surfaces ② and contact pins ① with a mild cleaning agent and a soft cloth.
Do not oil or grease contact plates ② or contact pins ①.

Cleaning the trailer tow hitch

🌿 Environmental note

Dispose of rags soaked in oil and grease in an environmentally responsible manner.

! Do not clean the ball coupling with a power washer. Do not use solvents.

! Observe the notes on additional care for the trailer tow hitch (see the manufacturer's operating instructions).

You can also have the maintenance work on the ball coupling and the trailer tow hitch carried out by a qualified specialist workshop.

Interior

Cleaning the interior

! When using liquids to clean the vehicle interior, observe the following points:

- Under no circumstances use power washers.
- Make sure that no fluids enter or remain in gaps and cavities.

- Ensure sufficient ventilation when cleaning.
- Make sure that the vehicle interior is completely dry after cleaning.

Cleaning the display

! For cleaning, do not use any of the following:

- alcohol-based thinner or gasoline
- abrasive cleaning agents
- commercially-available household cleaning agents

These may damage the display surface. Do not put pressure on the display surface when cleaning. This could lead to irreparable damage to the display.

- ▶ Switch off the display and let it cool down.
- ▶ Clean the display surface with a commercially available microfiber cloth and cleaner for TFT/LCD displays.
- ▶ Dry the display surface using a dry microfiber cloth.

Cleaning the plastic trim

WARNING

Care products and cleaning agents containing solvents cause surfaces in the cockpit to become porous. As a result, plastic parts may come loose in the event of air bag deployment. There is a risk of injury.

Do not use any care products and cleaning agents to clean the cockpit.

! Do not affix the following to plastic surfaces:

- stickers
- films
- scented oil bottles or similar items

You can otherwise damage the plastic.

! Do not allow cosmetics, insect repellent or sunscreen to come into contact with the plastic trim. This maintains the high-quality look of the surfaces.

- ▶ Wipe the plastic trim and the cockpit with a damp, lint-free cloth, e.g. a microfiber cloth.
- ▶ **Heavy soiling:** use a mild detergent or care products and cleaning agents recommended and approved by Mercedes-Benz.

Cleaning the steering wheel and selector lever

- ▶ Thoroughly wipe with a damp cloth.
- ▶ **Vehicles with leather upholstery:** after cleaning, use leather care agents that have been recommended and approved by Mercedes-Benz.

Cleaning the trim elements

! Do not use solvent-based cleaning agents such as tar remover, wheel cleaners, polishes or waxes. There is otherwise a risk of damaging the surface.

- ▶ Wipe the trim elements with a damp, lint-free cloth, e.g. a microfiber cloth.
- ▶ **Heavy soiling:** use care products and cleaning agents recommended and approved by Mercedes-Benz.

Cleaning the seat covers

! Do not use microfiber cloths to clean genuine leather or artificial leather covers. If used often, a microfiber cloth can damage the cover.

! Clean:

- artificial leather covers with a cloth moistened with a solution containing 1 % detergent, e.g. dish washing liquid.
- cloth covers with a microfiber cloth moistened with a solution containing 1 % detergent, e.g. dish washing liquid. Wipe entire seat sections carefully to avoid leaving visible lines. Leave the seat to dry afterwards. Cleaning results depend on the type of dirt and how long it has been there.
- genuine leather covers carefully with a damp cloth, then wipe the covers down with a dry cloth. Make sure that the leather does not become soaked. Otherwise, the leather could become rough or cracked. Only use leather care agents that have been tested and approved by Mercedes-Benz. You can obtain these from a qualified specialist workshop.

i Please keep in mind that:

- leather covers are a natural product and, as such, are subject to a natural aging process. Leather may react differently, e.g.

increased wrinkling, to certain environmental influences (such as high humidity or intense heat).

- regular care is essential to make sure that the appearance and comfort of the covers are retained over time.

To clean genuine leather covers:

- ▶ Remove any dust, crumbs etc. If necessary, carefully vacuum-clean the seat covers.
- ▶ Carefully wipe the leather seat covers with a damp cloth.
- ▶ Wipe over again with a dry cloth.
Make sure that the leather does not become soaked, especially perforated parts.
- ▶ Then treat the leather seats with a leather care foam.

Only use leather care agents that have been tested and approved by Mercedes-Benz. Observe the manufacturer's instructions.

Cleaning the seat belts

WARNING

Seat belts can become severely weakened if bleached or dyed. This could cause the seat belts to tear or fail, for instance, in the event of an accident. This poses an increased risk of injury or fatal injury.

Never bleach or dye the seat belts.

- ❗ Do not clean the seat belts using chemical cleaning agents. Do not dry the seat belts by heating at temperatures above 176 °F (80 °C) or in direct sunlight.

Remove any stains or dirt immediately. This will avoid residue or damage.

- ▶ Use clean, lukewarm water and soap solution.

Cleaning the headliner and carpets

- ▶ **Headliner:** if it is very dirty, use a soft brush or dry shampoo.
- ▶ **Carpets:** use the carpet and textile cleaning agents recommended and approved by Mercedes-Benz.

Useful information

This Operator's Manual describes all models as well as standard and optional equipment of your vehicle that were available at the time of going to print. Country-specific variations are possible. Note that your vehicle may not be equipped with all of the described functions. This also applies to systems and functions relevant to safety.

Read the information on qualified specialist workshops (▷ page 31).

Where will I find...?

Vehicle tool kit

General notes

Depending on the equipment version of the vehicle, the vehicle tool kit is:

- in the seat base of the left front seat
- in the rear stowage compartment
- in the tool holder in the cargo compartment

Apart from some country-specific variants, vehicles without a spare wheel are not equipped with tire-changing tools. If your vehicle is equipped with tire-changing tools, these are in the vehicle tool kit. If the vehicle tool kit is stowed in the driver's seat base, the jack is in a separate holder in the cargo compartment on the right-hand side of the vehicle next to the tailgate/rear door (▷ page 272).

Some tools for changing a wheel are specific to the vehicle. For more information on which tools are required and approved to perform a wheel change on your vehicle, consult a qualified specialist workshop.

Necessary tire-changing tools can include, for example:

- jack
- lug wrench
- ratchet wrench

i The jack has a maximum weight of 7.5 kg depending on the vehicle's equipment.

The maximum payload of the jack can be found on the sticker on the jack itself.

The jack is maintenance-free. In the event of a malfunction, please contact a qualified specialist workshop.

Stowage compartment in the seat base

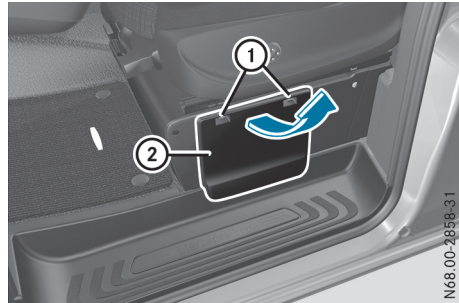

Stowage compartment in the seat base of the left front seat

- ▶ **To open:** press both latching springs ① down and release cover ② upwards from the seat base.
- ▶ Remove cover ② by pulling upwards at an angle from the seat base.
- ▶ Remove the clamping strap and remove the vehicle tool kit.
For vehicles equipped with tire-changing tools, the jack is in a separate holder in the cargo compartment on the right-hand side of the vehicle next to the tailgate/rear door (▷ page 272).
- ▶ **To close:** after stowing the vehicle tool bag, insert cover ② in front of the stowage compartment in the seat base and fold shut. Latching springs ① of cover ② must engage audibly.

Stowage compartment in the rear

Opening/closing the stowage compartment

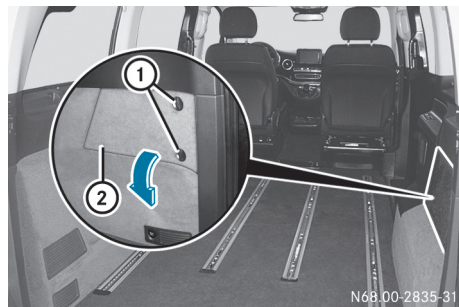

Stowage compartment in the rear on the right-hand side of the vehicle

- ▶ **To open:** turn top rotary catch ① clockwise and bottom rotary catch ① counter-clockwise.
- ▶ Remove cover ②.
- ▶ **To close:** insert cover ②.
- ▶ Turn top rotary catch ① counter-clockwise and bottom rotary catch ① clockwise.
- ▶ Fold down the rear seat.

Removing/stowing vehicle tool kit and jack

Depending on the equipment version of the vehicle, the vehicle tool kit and the jack are stowed either in a stowage tray or in a tool holder with a cover.

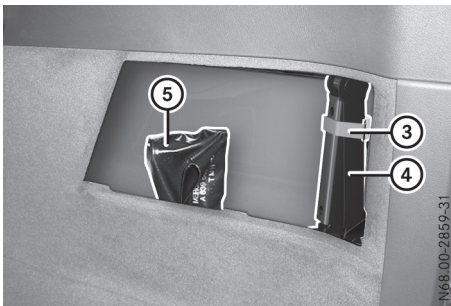

Stowage compartment with stowage tray

- ▶ **To remove tools:** open the stowage compartment.
- ▶ Open clamping strap ③ and remove jack ④ by pulling it upwards at an angle from the stowage tray compartment.
- ▶ Remove vehicle tool bag ⑤ upwards from the stowage tray compartment.
- ▶ **To stow tools:** insert vehicle tool bag ⑤ into the front compartment of the stowage tray.
- ▶ Before stowing, wind jack ④ to the fully closed position and place it so that the hand wheel is facing downwards and the plate is facing inwards at an angle.
- ▶ Insert jack ④ into the back compartment of the stowage tray.
- ▶ Press jack ④ into the upper holder and fasten clamping strap ③. The jack is secured.
- ▶ Close the stowage compartment.

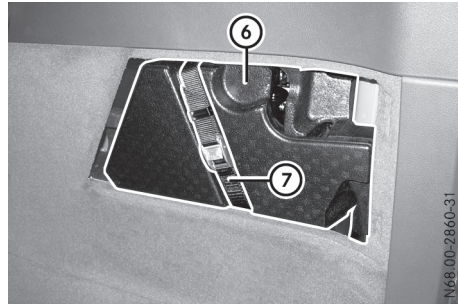

Stowage compartment with tool holder

- ▶ **To remove tools:** open the stowage compartment.
- ▶ Remove clamping strap ⑦.
- ▶ Remove tool holder cover ⑥.
- ▶ Carefully pull the tool kit and jack out of the stowage compartment. Lift the jack slightly before removing it and turn it to a diagonal position in the stowage compartment.
- ▶ **To stow tools:** before stowing, wind the jack to the fully closed position and place it so that the hand wheel is facing forwards and the plate is facing inwards.
- ▶ Place the jack and vehicle tool kit into the tool holder.
- ▶ Replace tool holder cover ⑥.
- ▶ Tighten clamping strap ⑦.
- ▶ Close the stowage compartment.

Stowage space in the cargo compartment

Tool holder in the cargo compartment

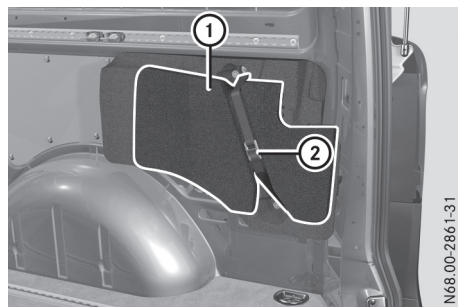

Tool holder in the cargo compartment on the right-hand side of the vehicle

- ▶ **To remove tools:** release clamping strap ②.
- ▶ Remove tool holder cover ①
- ▶ Carefully pull the tool kit and jack out of the tool holder.
- ▶ **To stow tools:** before stowing, wind the jack to the fully closed position and place it so that the hand wheel is facing forwards and the plate is facing inwards.
- ▶ Place the jack and vehicle tool kit into the tool holder.
- ▶ Replace tool holder cover ①.
- ▶ Tighten clamping strap ②.

Separate holder for jack

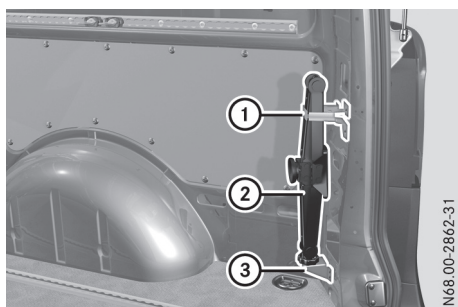

Holder for the jack in the cargo compartment on the right-hand side of the vehicle

The vehicle tool kit or tire-changing tools are in the seat base of the left front seat (▷ page 270).

- ▶ **To remove the jack:** release clamping strap ①.
- ▶ Pull jack ② out of the upper holder and from the lower fixture ③.
- ▶ **To stow the jack:** before stowing, wind the jack to the fully closed position and place it so that the hand wheel is facing forwards and the plate is facing inwards.
- ▶ Place jack ② onto lower fixture ③.
- ▶ Press jack ② into the upper holder and fasten clamping strap ①.
The jack is secured.

First-aid kit

Removing the first-aid kit

The first-aid kit is located in the stowage compartment in the front-passenger door.

- ❗ Check the expiration date on the first-aid kit at least once a year. Replace any expired or missing contents.

Observe the legal requirements of the country in which you are currently driving.

Flat tire

In your vehicle, you will find a sticker with the Mercedes-Benz Service24h telephone number, e.g. on the B-pillar on the driver's side.

For vehicles with a spare wheel, information on breakdown assistance in the event of a flat tire can be found under "Wheels and tires" (▷ page 296).

Jump-starting

Important safety notes

⚠ WARNING

During charging and jump-starting, explosive gases can escape from the battery. There is a risk of an explosion.

Particularly avoid fire, open flames, creating sparks and smoking. Ensure there is sufficient ventilation while charging and jump-starting. Do not lean over a battery.

⚠ WARNING

Battery acid is caustic. There is a risk of injury. Avoid contact with skin, eyes or clothing. Do not inhale any battery gases. Do not lean over the battery. Keep children away from batteries. Wash away battery acid immediately with plenty of clean water and seek medical attention.

⚠ WARNING

A discharged battery can freeze at temperatures below freezing point. When jump-starting the vehicle or charging the battery, gases can escape from the battery. There is a risk of an explosion.

Allow the frozen battery to thaw out before charging it or jump-starting.

⚠ Vehicles with a gasoline engine: avoid repeated and lengthy starting attempts. Otherwise, the catalytic converter could be damaged by non-combusted fuel.

If the indicator and warning lamps in the instrument cluster do not light up at low temperatures, the discharged battery may have frozen. In this case you may neither charge the battery nor jump-start the vehicle. The service life of a thawed battery may be shorter. Start-up behavior may deteriorate, in particular at low temperatures. Have the thawed battery checked at a qualified specialist workshop.

Do not use a rapid charging device to start the vehicle. If your vehicle's battery is discharged, the engine can be jump-started from another vehicle or from a donor battery using jumper cables. For this purpose, the vehicle has a jump-starting connection point in the engine compartment.

When jump-starting, observe the following points:

- The battery is not accessible in all vehicles. If the other vehicle's battery is not accessible, jump-start the vehicle using a donor battery or a jump-starting device.
- You may only jump-start the vehicle when the engine and exhaust system are cold.
- do not start the engine if the battery is frozen. Let the battery thaw first.
- jump-starting may only be performed from batteries with a nominal voltage of 12 V.
- only use jumper cables that have a sufficient cross-section and insulated terminal clamps.
- if the battery is fully discharged, attach the battery of another vehicle for a few minutes before attempting to start. This charges the empty battery a little.
- make sure that the two vehicles do not touch.

Make sure that:

- the jumper cables are not damaged.
- bare parts of the terminal clamps do not come into contact with other metal parts while the jumper cables are connected to the battery.
- the jumper cables cannot come into contact with parts such as the V-belt pulley or the fan. These parts move when the engine is started and while it is running.

Jumper cables and further information regarding jump starting can be obtained at any qualified specialist workshop.

Before connecting the jumper cables

- ▶ Apply the parking brake.
- ▶ Shift the transmission to position **P**.
- ▶ Switch off all electrical consumers, e.g. audio equipment, blower.
- ▶ Turn the key to position **0** in the ignition lock and remove it.
- ▶ Open the hood (▷ page 251).

Connecting the jumper cable

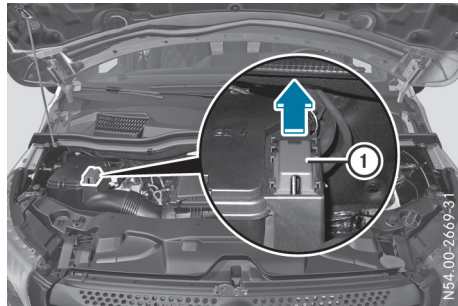

- ▶ Push contact protection cover ① of the jump-starting connection point backwards against the spring force as far as it will go. The jump-starting connection point is visible.

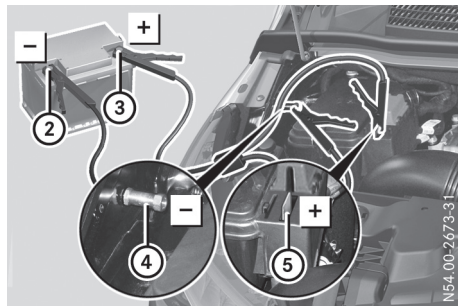

Terminal connecting plan

- ▶ Remove the cover from positive terminal ③ of the donor vehicle's battery.
- ▶ Connect the positive terminal clamp of the jumper cable to positive terminal ③ of the donor vehicle's battery, and then to positive terminal ⑤ of the jump-starting connection point.
- ▶ Run the donor vehicle's engine at idling speed.

- ▶ Connect the negative terminal clamp of the jumper cable to negative terminal ② of the donor vehicle's battery, and then to earth contact ④ of your own vehicle.
- ▶ Insert the key into the ignition lock and start the engine.
You can now switch electrical consumers back on except the lighting system.
- ▶ Before disconnecting the jumper cables, let the engine run for several minutes.
- ▶ Disconnect the negative terminal of the jumper cable from earth contact ④ and then from negative terminal ② of the donor vehicle's battery.
- ▶ Disconnect the positive terminal clamp of the jumper cable from positive terminal ⑤ on the jump-starting connection point, and then from positive terminal ③ of the donor vehicle's battery.
Contact protection cover ① is automatically returned forwards to its original position by the spring force and the jump-starting connection point is closed.
- ▶ Position the cover on positive terminal ③ of the donor vehicle's battery.
You can now switch on the lighting system.
- ▶ Have the battery checked at a qualified specialist workshop.

Tow-starting and towing away

Important safety notes

WARNING

Functions relevant to safety are restricted or no longer available if:

- the engine is not running.
- the brake system or the power steering is malfunctioning.
- there is a malfunction in the voltage supply or the vehicle's electrical system.

If your vehicle is being towed, much more force may be necessary to steer or brake. There is a risk of an accident.

In such cases, use a tow bar. Before towing, make sure that the steering moves freely.

WARNING

You can no longer steer the vehicle if the steering wheel lock has been engaged. There is a risk of an accident.

Always switch off the ignition when towing the vehicle with a tow cable or a tow bar.

WARNING

When towing or tow-starting another vehicle and its weight is greater than the permissible gross weight of your vehicle, the:

- the towing eye could detach itself
- the vehicle/trailer combination could roll-over.

There is a risk of an accident.

When towing or tow-starting another vehicle, its weight should not be greater than the permissible gross weight of your vehicle.

Information on the gross vehicle weight can be found on the vehicle identification plate (▷ page 303).

- ❗ Secure the tow rope or tow bar to the towing eye or trailer tow hitch only. Otherwise, the vehicle could become damaged.
- ❗ Do not use the towing eye for recovery, this could damage the vehicle. If in doubt, recover the vehicle with a crane.
- ❗ Drive slowly and smoothly when towing. Excessive tractive power could otherwise damage the vehicles.
- ❗ Shift the automatic transmission to **N** and do not open the driver's or front passenger's door during towing. The automatic transmission may otherwise shift to position **P**, which could damage the transmission.
- ❗ The vehicle can be towed a maximum of 30 miles (50km). The towing speed of 30 mph (50 km/h) must not be exceeded.
If the vehicle has to be towed more than 30 miles (50km), the entire vehicle must be raised and transported.

When towing away, you must observe the legal requirements for the country in which you are currently driving.

It is better to have the vehicle transported than to have it towed.

Have the vehicle transported on a transporter or trailer if it has transmission damage.

When towing, the automatic transmission must be in position **N**. If the automatic transmission cannot be shifted to position **N**, have the vehicle transported on a transporter or trailer.

The battery must be connected and charged. Otherwise, you:

- cannot turn the key to position **2** in the ignition lock
- cannot shift the transmission to position **N**

Before the vehicle is towed, switch off the automatic locking feature (▷ page 74). You could otherwise lock yourself out of the vehicle when pushing or towing away the vehicle.

Installing/removing the towing eye

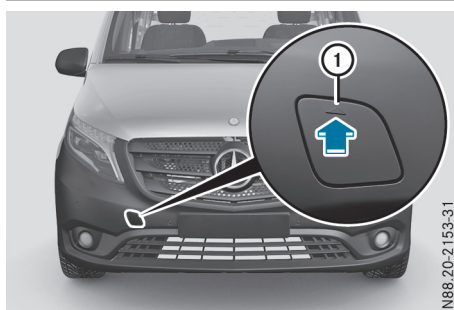

N88.20-2153-31

The fixture for the front towing eye is located in the bumper.

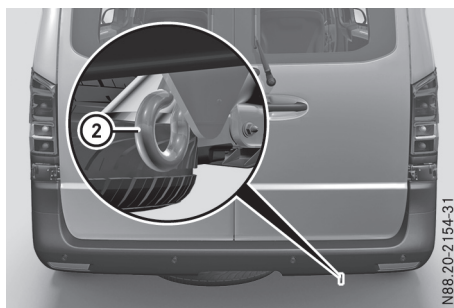

N88.20-2154-31

The rear towing eye is located under the bumper. If you tow or tow-start a vehicle, attach the towing device to rear towing eye ②.

If your vehicle is equipped with a trailer tow hitch, attach the towing device to the trailer tow hitch (▷ page 163).

Installing the front towing eye

- ▶ Take the towing eye and screwdriver from the vehicle tool kit (▷ page 270).
- ▶ Press the arrow on the cover ① and remove cover ① from the opening. You will see the fixture for the towing eye.
- ▶ Screw in the towing eye clockwise to the stop.
- ▶ Insert the screwdriver into the towing eye and tighten the towing eye.
- ▶ Stow the screwdriver in the vehicle tool kit (▷ page 270).

Removing the front towing eye

- ▶ Remove the screwdriver from the vehicle tool kit (▷ page 270).
- ▶ Insert the screwdriver into the towing eye and turn the screwdriver counter-clockwise.
- ▶ Unscrew the towing eye.
- ▶ Insert cover ① with the lug at the top and press it in at the bottom until it engages.
- ▶ Stow the towing eye and the screwdriver with the vehicle tool kit (▷ page 270).

Towing with the rear axle raised

❗ Vehicles with automatic transmission must not be towed with the rear axle raised. The vehicle/trailer combination may otherwise swerve or even roll over.

❗ The ignition must be switched off if the vehicle is being towed with the front or rear axle raised. Otherwise, ESP® may intervene and damage the brake system.

- ▶ Switch on the hazard warning lamps (▷ page 96).
- ▶ Turn the front wheels to the straight-ahead position.
- ▶ Release the parking brake.
- ▶ If necessary, turn the key to position **0** in the ignition lock and remove it.
- ▶ Take the key with you when leaving the vehicle.
- ▶ Do not exceed the towing speed of 30 mph (50 km/h).

Please observe the important safety instructions when towing your vehicle with the rear axle raised (▷ page 274).

Towing the vehicle with both axles on the ground

Important safety notes

WARNING

You can no longer steer the vehicle if the steering wheel lock has been engaged. There is a risk of an accident.

Always switch off the ignition when towing the vehicle with a tow cable or a tow bar.

- ❗ Do not exceed the towing speed of 30 mph (50 km/h). You could otherwise damage the transmission.

Please observe the important safety notes before towing your vehicle (▷ page 274).

Towing vehicles with automatic transmission

- ▶ Turn the key to position **2** in the ignition lock.
- ▶ Depress the brake pedal and keep it depressed.
- ▶ Shift the automatic transmission to position **N**.
- ▶ Leave the key in position **2** in the ignition lock.
- ▶ Switch on the hazard warning lamps (▷ page 96).
- ▶ Release the parking brake.
- ▶ Release the brake pedal.
- ▶ Do not exceed the towing speed of 30 mph (50 km/h).

Recovering a vehicle that is stuck

- ❗ When recovering a vehicle that has become stuck, pull it as smoothly and evenly as possible. Excessive tractive power could damage the vehicles.

If the drive wheels get trapped on loose or muddy ground, recover the vehicle with the utmost care. This is especially the case if the vehicle is laden.

Never attempt to recover a vehicle with a trailer attached.

Pull out the vehicle backwards, if possible, using the tracks it made when it became stuck.

Transporting the vehicle

- ❗ You may only secure the vehicle by the wheels, not by parts of the vehicle such as axle or steering components. Otherwise, the vehicle could be damaged.

The towing eye or trailer tow hitch can be used to pull the vehicle onto a trailer or transporter if you wish to transport it.

- ▶ Turn the key to position **2** in the ignition lock.
- ▶ Shift the transmission to position **N**.
- ▶ Release the parking brake.

If the vehicle is loaded:

- ▶ Shift the transmission to position **P**.
- ▶ Turn the key to position **0** in the ignition lock and remove it.
- ▶ Make sure the parking brake is applied.
- ▶ Lash down the vehicle.

Tow-starting (emergency engine starting)

General notes

- ❗ Vehicles with automatic transmission must not be tow-started. You could otherwise damage the automatic transmission.

You can find information on jump-starting under "Jump-starting" (▷ page 272).

Electrical fuses

The fuse allocation chart and important safety information on the fuses can be found in the "Fuse allocation chart" supplement.

Useful information

This Operator's Manual describes all models as well as standard and optional equipment of your vehicle that were available at the time of going to print. Country-specific variations are possible. Note that your vehicle may not be equipped with all of the described functions. This also applies to systems and functions relevant to safety.

Read the information on qualified specialist workshops (▷ page 31).

Important safety notes

Warning

A flat tire severely impairs the driving, steering and braking characteristics of the vehicle. There is a risk of an accident.

do not drive with a flat tire. Immediately replace the flat tire with your spare wheel, or consult a qualified specialist workshop.

WARNING

If wheels and tires of the wrong size are used, the wheel brakes or suspension components may be damaged. There is a risk of an accident.

Always replace wheels and tires with those that fulfill the specifications of the original part.

When replacing wheels, make sure to use the correct:

- designation
- model

When replacing tires, make sure to use the correct:

- designation
- manufacturer
- model

Accessories that are not approved for your vehicle by Mercedes-Benz or are not being used correctly can impair operating safety.

Before purchasing and using non-approved accessories, visit a qualified specialist workshop and inquire about:

- suitability
- legal stipulations
- factory recommendations

Information on the dimensions and types of wheels and tires for your vehicle can be found under "Wheel and tire combinations" .

Information on your vehicle's tire pressure can be found:

- in the Tire and Loading Information placard on the B-pillar, driver's side
- in the tire pressure table inside the fuel filler flap (▷ page 281)
- under "Tire pressure tables" (▷ page 288)
- under "Tire pressure" (▷ page 280)

Modifications to the brake system or wheels are not permitted. The use of a spacer and brake dust shields is not permitted. This invalidates the general operating permit for the vehicle.

Further information on wheels and tires can be obtained at any qualified specialist workshop.

Operation

Information for a journey

If the vehicle is heavily laden, check the tire pressures, and correct them, if necessary (▷ page 280).

While driving, pay attention to vibrations, noises and unusual handling characteristics, e.g. pulling to one side. This may indicate that the wheels or tires are damaged. If you suspect that a tire is defective, reduce your speed immediately. Stop the vehicle as soon as possible to check the wheels and tires for damage. Hidden tire damage could also be causing the unusual handling characteristics. If you find no signs of damage, have the tires and wheels checked at a qualified specialist workshop.

When parking your vehicle, make sure that the tires do not get deformed by the curb or other obstacles. If it is necessary to drive over curbs, speed humps or similar elevations, try to do so slowly and not at a sharp angle. Otherwise, the tires, particularly the sidewalls, can get damaged.

Regular wheel and tire checks

WARNING

Damaged tires can cause tire inflation pressure loss. As a result, you could lose control of your vehicle. There is a risk of accident.

Check the tires regularly for signs of damage and replace any damaged tires immediately.

Check the wheels and tires of your vehicle for damage regularly, i.e. at least every two weeks, as well as after driving off-road or on rough roads. Damaged wheels can cause a loss of tire pressure. Pay particular attention to damage such as:

- cuts in the tires
- punctures
- tears in the tires
- bulges on tires
- deformation or severe corrosion on wheels

Regularly check the tire tread depth and the condition of the tread across the whole width of the tire (> page 278). If necessary, turn the front wheels to full lock in order to inspect the inner side of the tire surface.

All wheels must have a valve cap to protect the valve against dirt and moisture. Do not install anything onto the valve other than the standard valve cap or other valve caps approved for your vehicle by dealers listed on the inside of the front cover. Do not install any other valve caps or systems, e.g. tire pressure monitor systems. Regularly check the pressure of all the tires, particularly prior to long trips. Adjust the tire pressure if necessary (> page 280).

The service life of tires depends on various factors, including the following:

- driving style
- tire pressure
- mileage

Tire tread

WARNING

Insufficient tire tread will reduce tire traction. The tire is no longer able to dissipate water. This means that on wet road surfaces, the risk of hydroplaning increases, in particular where

speed is not adapted to suit the driving conditions. There is a risk of accident.

If the tire pressure is too high or too low, tires may exhibit different levels of wear at different locations on the tire tread. Thus, you should regularly check the tread depth and the condition of the tread across the entire width of all tires.

Minimum tire tread depth for:

- Summer tires: $\frac{1}{8}$ in (3 mm)
- M+S tires: $\frac{1}{8}$ in (4 mm)

For safety reasons, replace the tires before the legally prescribed limit for the minimum tire tread depth is reached.

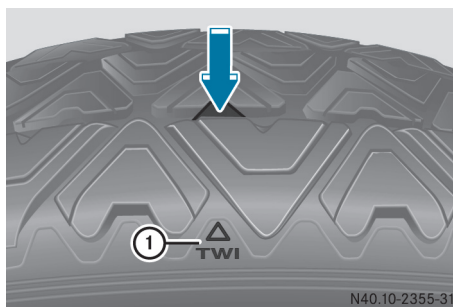

Marker ① shows the location where the bar indicator (arrow) for tread wear is integrated into the tire tread.

Tread wear indicators (TWIs) are required by law. Six indicators are positioned over the tire tread. They are visible once the tread depth is approximately $\frac{1}{16}$ in (1.6 mm). If this is the case, the tire is so worn that it must be replaced.

Selecting, mounting and replacing tires

- Only mount tires and wheels of the same type and make.
- Only use wheels with tire sizes approved by Mercedes-Benz.
- Only mount tires of the correct size onto the wheels.
- Break in new tires at moderate speeds for the first 65 miles (100 km).

- Do not drive with tires which have too little tread depth, as this significantly reduces the traction on wet roads (hydroplaning).
- Replace the tires after six years at the latest, regardless of wear. This also applies to the spare wheel.

Operation in winter

General notes

Have your vehicle winterproofed at a qualified specialist workshop at the onset of winter.

Only use wheels with tire sizes approved by Mercedes-Benz.

Prior to the onset of winter, ensure that snow chains are stowed in the vehicle (▷ page 280). Snow chains cannot be mounted on all wheel/tire combinations. Observe the restrictions on the use of snow chains under "Wheel/tire combinations" (▷ page 300).

Also observe the notes in the "Changing a wheel" section (▷ page 296).

Driving with summer tires

At temperatures below 45 °F (+7 °C), summer tires lose elasticity and therefore traction and braking power. Change the tires on your vehicle to M+S tires. Using summer tires at very cold temperatures could cause tears to form, thereby damaging the tires permanently. Mercedes-Benz cannot accept responsibility for this type of damage.

M+S tires

WARNING

Wheel and tire dimensions as well as the type of tire can vary between the spare wheel and the wheel to be replaced. When the spare wheel is mounted, driving characteristics may be severely affected. There is a risk of an accident.

In order to reduce risks:

- you should therefore adapt your driving style and drive carefully.
- never mount more than one spare wheel that differs from the wheel to be replaced.
- only use a spare wheel that differs from the wheel to be replaced for a short time.
- have a spare wheel that differs from the wheel that has been changed replaced at the nearest qualified specialist workshop. You must observe the correct wheel and tire dimensions as well as the wheel type.

WARNING

M+S tires with a tire tread depth of less than $\frac{1}{8}$ in (4 mm) are not suitable for use in winter and do not provide sufficient traction. There is a risk of an accident.

M+S tires with a tread depth of less than $\frac{1}{8}$ in (4 mm) must be replaced immediately.

Use winter tires or all-season tires at temperatures below 45 °F (+7 °C). Both types of tire are identified by the M+S marking.

Only winter tires bearing the  snowflake symbol in addition to the M+S marking provide the best possible grip in wintry road conditions.

Only these tires will allow driving safety systems such as ABS and ESP® to function optimally in winter. These tires have been developed specifically for driving in snow.

For safe driving, use M+S tires of the same make and tread pattern on all wheels.

Always observe the maximum permissible speed specified for the M+S tires you have mounted.

If you mount M+S tires that have a lower maximum permissible speed than the maximum design speed of the vehicle, affix a corresponding warning label in the driver's field of vision. You can obtain this at a qualified specialist workshop.

Once you have mounted the winter tires:

- ▶ Check the tire pressure (▷ page 280).
- ▶ Restart the tire pressure monitor (▷ page 287).

Snow chains **WARNING**

If snow chains are installed to the front wheels, they may drag against the vehicle body or chassis components. This could cause damage to the vehicle or the tires. There is a risk of an accident.

To avoid hazardous situations:

- never install snow chains to the front wheels
- always install snow chains in pairs to the rear wheels.

 **WARNING**

If you drive too fast with snow chains mounted, they may snap. As a result, you could injure others and damage the vehicle. There is a risk of an accident.

Observe the maximum permissible speed for operation with snow chains.

Observe the country-specific laws and regulations for operation with snow chains.

! Check the snow chains for damage before mounting them. Damaged or worn snow chains may snap and damage the following components:

- wheel
- wheel housing
- wheel suspension

For this reason, you must use only snow chains that are free of defects. Observe the manufacturer's mounting instructions.

! **Vehicles with steel wheels:** if you mount snow chains on steel wheels, you may damage the hub caps. Remove the hub caps from the relevant wheels before mounting the snow chains.

Snow chains increase traction on roads in wintry conditions.

For safety reasons, Mercedes-Benz recommends that you only use snow chains or traction aids which have been approved for Mercedes-Benz vehicles. The snow chains or traction aids must be of class U or meet the SAE type U specification.

Information about snow chains can be obtained from any Mercedes-Benz Commercial Van Center.

When mounting snow chains, please bear the following points in mind:

- Snow chains cannot be mounted on all wheel/tire combinations. When mounting the snow chains, note the permissible tire and snow chain dimensions. Observe the restrictions on the use of snow chains under "Wheel/tire combinations" (▷ page 300).
- Mount snow chains only in pairs and only to the rear wheels. Observe the manufacturer's mounting instructions.
- Only use snow chains when the road is covered by a layer of snow. Remove the snow chains as soon as possible when you come to a road that is not snow-covered.
- The use of snow chains may be restricted by local regulations. Observe the appropriate regulations before mounting snow chains.
- When driving with snow chains installed, do not exceed the maximum permissible speed of 30 mph (50 km/h).
- Check the tension of the chains after a distance of approximately 0.5 miles (1.0 km).

You may wish to deactivate ESP® when pulling away with snow chains installed (▷ page 66). This allows the wheels to spin in a controlled manner, achieving an increased driving force (cutting action).

Tire pressure**Tire pressure specifications****Important safety notes** **WARNING**

Underinflated or overinflated tires pose the following risks:

- the tires may burst, especially as the load and vehicle speed increase.
- the tires may wear excessively and/or unevenly, which may greatly impair tire traction.
- the driving characteristics, as well as steering and braking, may be greatly impaired.

There is a risk of an accident.

Follow recommended tire inflation pressures and check the pressure of all the tires including the spare wheel:

- monthly, at least
- if the load changes
- before beginning a long journey
- under different operating conditions, e.g. off-road driving

If necessary, correct the tire pressure.

WARNING

If you fit unsuitable accessories onto tire valves, the tire valves may be overloaded and malfunction, which can cause tire pressure loss. Due to their design, retrofitted tire pressure monitors keep the tire valve open. This can also result in tire pressure loss. There is a risk of an accident.

Only screw the standard valve cap or other valve caps approved by Mercedes-Benz for your vehicle onto the tire valve.

! The pressure difference between tires on any one axle must be no greater than 10 kPa (0.1 bar/1.5 psi).

i The specifications shown on the sample Tire and Loading Information placard and tire pressure table are examples. Tire pressure data are vehicle-specific and may deviate from the data illustrated here. The tire pressure specifications that are valid for your vehicle can be found on the Tire and Loading Information placard and the tire pressure table on the vehicle.

Environmental note

Check the tire pressure regularly, at least every 14 days.

General notes

You will find information on tire pressure for the vehicle's factory-mounted tires on the plates described here.

The recommended tire pressure for various operating conditions can be found on the Tire and Loading Information placard on the B-pillar on the driver's side of the vehicle or on the tire pressure table inside the fuel filler flap.

Further information on tire pressure can be obtained at a qualified specialist workshop.

Tire and Loading Information placard

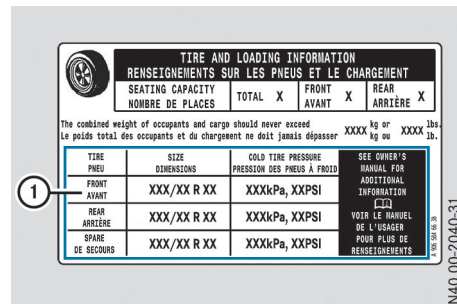

Example: Tire and Loading Information placard

The Tire and Loading Information placard is on the B-pillar on the driver's side of the vehicle.

The Tire and Loading Information placard contains recommended tire pressures **①** for cold tires. Recommended tire pressures **①** are valid for the maximum permissible load and up to the maximum permissible speed of the vehicle.

Tire pressure table

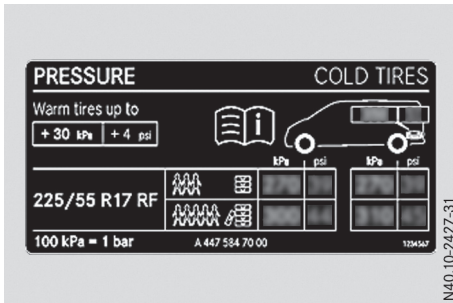

Tire pressure table inside the fuel filler flap (example: Passenger Van)

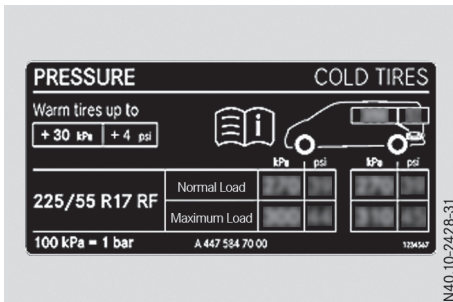

Tire pressure table inside the fuel filler flap (example: Cargo Van)

You will find the recommended tire pressure for various operating conditions on the inside of your vehicle's fuel filler flap (▷ page 133) and under "Tire pressure table" (▷ page 288).

If a tire size precedes a tire pressure, the following tire pressure information is only valid for that tire size.

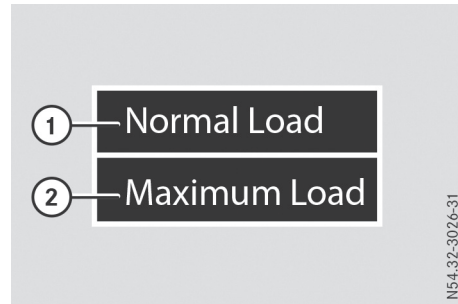

Example: Cargo Van vehicle loads

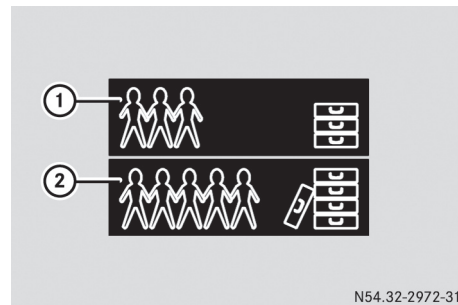

Example: Passenger Van vehicle loads

- ① Partially laden vehicle
- ② Fully laden vehicle

For the Passenger Van, the vehicle loads are defined in the table as different numbers of passengers and amounts of luggage. The actual number of seats may vary – for more information, please refer to the vehicle's registration documents.

The tire pressure value given for partly laden vehicles are minimum values which offer you good ride comfort. They are not for towing trailers.

You can also use the tire pressure values for a fully laden vehicle. These are always permitted and admissible. However, in a partially laden vehicle, the ride is not as comfortable and fuel consumption is only minimally reduced. In addition, wear is greater in the center of the tire tread.

For towing trailers, the applicable value for the rear tires is the maximum tire pressure value stated in the table inside the fuel filler flap.

Important notes on tire pressure

WARNING

If the tire pressure drops repeatedly, the wheel, valve or tire may be damaged. Tire pressure that is too low may result in a tire blow-out. There is a risk of an accident.

- Check the tire for foreign objects.
- Check whether the wheel is losing air or the valve is leaking.

If you are unable to rectify the damage, contact a qualified specialist workshop.

Use a suitable pressure gage to check the tire pressure. The outer appearance of a tire does not permit any reliable conclusion about the tire pressure. On vehicles equipped with the electronic tire pressure monitor, the tire pressure can be checked using the on-board computer. The tire temperature and pressure increase when the vehicle is in motion. This is dependent on the driving speed and the load.

Therefore, you should only correct tire pressure when the tires are cold.

The tires are cold:

- if the vehicle has been parked for at least three hours without direct sunlight on the tires, and
- if the vehicle has not been driven further than 1 mile (1.6 km)

Tire temperature changes depending on the ambient temperature, driving speed and tire load. If the tire temperature changes by 18 °F (10 °C), the tire pressure changes by approximately 10 kPa (0.1 bar/1.5 psi). Take this into account when checking the pressure of warm tires. Only correct the tire pressure if it is too low for the current operating conditions. If you check the tire pressure when the tires are warm, it results in a higher value than when the tires are cold. This is normal. Do not under any circumstances release the air in order to adjust the pressure to the prescribed value for cold tires. The tire pressure would otherwise be too low.

Observe the recommended tire pressure for cold tires on the tire pressure table in the fuel filler flap.

Driving with tire pressure that is too high or too low can:

- shorten the service life of the tires
- cause increased tire damage
- have a negative effect on handling characteristics and thus the driving safety (e.g. hydroplaning)

Underinflated or overinflated tires

Underinflated tires:

WARNING

Tires with pressure that is too low can overheat and burst as a consequence. In addition, they also suffer from excessive and/or irregular wear, which can severely impair the braking properties and the driving characteristics. There is a risk of an accident.

Avoid tire pressures that are too low in all the tires, including the spare wheel.

Underinflated tires can:

- fail from being overheated
- adversely affect handling
- wear excessively and/or unevenly
- have an adverse effect on fuel consumption

Overinflated tires

WARNING

Tires with excessively high pressure can burst because they are damaged more easily by road debris, potholes etc. In addition, they also suffer from irregular wear, which can severely impair the braking properties and the driving characteristics. There is a risk of an accident.

Avoid tire pressures that are too high in all the tires, including the spare wheel.

Overinflated tires can:

- increase the braking distance
- adversely affect handling
- wear excessively and/or unevenly
- adversely affect ride comfort
- be more susceptible to damage

Maximum tire pressures

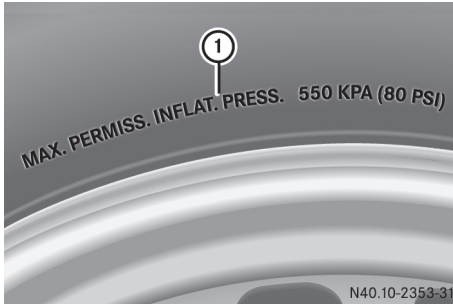

① Maximum permitted tire pressure (example)

Never exceed the maximum permissible tire inflation pressure. When adjusting the tire pressures always observe the recommended tire pressure for your vehicle (▷ page 280).

- i** The actual values for tires are specific to each vehicle and may deviate from the values in the illustration.

Tire valve (snap-in valve)

Important safety notes

⚠ WARNING

Tire valve that are not approved for your vehicle by the distributor named on the inside cover page may result in a loss of tire pressure. This may affect road safety. There is a risk of an accident.

Only use tire valve that are approved for your vehicle by the distributor named on the inside cover page. Always make sure you have the correct tire valve type for the tires on your vehicle.

- !** Do not screw additional weights (check valves, etc.) onto the tire valves. The electronic components could thus be damaged.
- i** For safety reasons, Mercedes-Benz recommends that you only use tire valves that have been tested for use on your vehicle.

Checking the tire pressure manually

In order to determine and adjust the tire pressures, proceed as follows:

- ▶ Remove the valve cap of the tire you wish to check.
- ▶ Press the tire pressure gauge securely onto the valve.
- ▶ Read the tire pressure and compare it with the recommended value on the loading information table or the tire pressure table (▷ page 280).
- ▶ If the tire pressure is too low, increase it to the recommended value.
- ▶ If the tire pressure is too high, release air by pressing down the metal pin in the valve. Use the tip of a pen, for example. Then, check the tire pressure again using the tire pressure gauge.
- ▶ Screw the valve cap onto the valve.
- ▶ Repeat the steps for the other tires.

Tire pressure monitor

General notes

In vehicles with a tire pressure monitor system, the vehicle's wheels have sensors installed which monitor the tire pressure in all four tires. The tire pressure monitor warns you if the pressure drops in one or more of the tires. The tire pressure monitor only functions if the corresponding sensors are installed on all wheels.

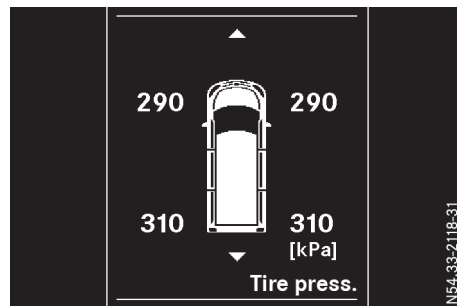

Tire pressure display (only on vehicles with steering wheel buttons)

On vehicles with steering wheel buttons, the current pressure of the individual tires can be shown in the display using the **Service** menu.

For further information on displaying the current tire pressures, refer to "Checking the tire pressure electronically" (> page 286).

Important safety notes

WARNING

Each tire, including the spare (if provided), should be checked at least once a month when cold and inflated to the pressure recommended by the vehicle manufacturer on the Tire and Loading Information placard on the driver's door B-pillar or the tire pressure label on the inside of the fuel filler flap. If your vehicle has tires of a different size than the size indicated on the Tire and Loading Information placard or the tire pressure label, you should determine the proper tire pressure for those tires.

As an added safety feature, your vehicle has been equipped with a tire pressure monitoring system (TPMS) that illuminates a low tire pressure telltale when one or more of your tires are significantly underinflated. Accordingly, when the low tire pressure telltale illuminates, you should stop and check your tires as soon as possible, and inflate them to the proper pressure. Driving on a significantly underinflated tire causes the tire to overheat and can lead to tire failure. Underinflation also reduces fuel efficiency and tire tread life, and may affect the vehicle's handling and stopping ability.

Please note that the TPMS is not a substitute for proper tire maintenance, and it is the driver's responsibility to maintain correct tire pressure, even if underinflation has not reached the level to trigger illumination of the TPMS low tire pressure telltale.

USA only:

Your vehicle has also been equipped with a TPMS malfunction indicator to indicate if the system is not operating properly. The TPMS malfunction indicator is combined with the low tire pressure telltale. When the system detects a malfunction, the warning lamp will flash for approximately a minute and then

remain continuously illuminated. This sequence will be repeated every time the vehicle is started as long as the malfunction exists.

When the malfunction indicator is illuminated, the system may not be able to detect or signal low tire pressure as intended. TPMS malfunctions may occur for a variety of reasons, including the mounting of incompatible replacement or alternate tires or wheels on the vehicle that prevent the TPMS from functioning properly. Always check the TPMS malfunction telltale after replacing one or more tires or wheels on your vehicle to ensure that the replacement or alternate tires and wheels allow the TPMS to continue to function properly.

It is the driver's responsibility to set the tire pressure to the recommended cold tire pressure suitable for the operating conditions (> page 280).

Note that the correct tire pressure for the current operating conditions must first be programmed into the tire pressure monitor. If there is a substantial loss of pressure, the warning threshold for the warning message is aligned to the reference values programmed in. Restart the tire pressure monitor after adjusting the cold tire pressure (> page 287). The current pressures are saved as new reference values. This will ensure that a warning message will only appear if the tire pressure drops significantly.

The tire pressure monitor does not warn you if a tire pressure is incorrect. Observe the notes on the recommended tire pressure (> page 280).

The tire pressure monitor is not able to warn you of a sudden loss of pressure, e.g. following penetration by a foreign object. In this event, brake the vehicle until it comes to a standstill. Avoid sudden steering movements.

The tire pressure monitor has a yellow  warning lamp in the instrument cluster for indicating pressure loss/malfunctions (USA) or pressure loss (Canada). Depending on how the warning lamp flashes or lights up, an underinflated tire or a malfunction in the tire pressure monitor is displayed:



- if the  warning lamp is lit continuously, the tire pressure on one or more tires is sig-

nificantly too low. The tire pressure monitor is not malfunctioning.

- USA only: if the  warning lamp flashes for 60 seconds and then remains lit constantly, the tire pressure monitor is malfunctioning.

The display also shows a message:

- on vehicles without steering wheel buttons (> page 201)
- on vehicles with steering wheel buttons (> page 217)

USA only: if the tire pressure monitor is malfunctioning, it may be more than ten minutes before the malfunction is shown. The  tire pressure warning lamp flashes for 60 seconds and then remains lit. When the malfunction has been rectified, the  tire pressure warning lamp goes out after a few minutes of driving.





The tire pressure values indicated by the on-board computer may differ from those measured at a gas station with a pressure gage. The tire pressures shown by the on-board computer refer to those measured at sea level. At high altitudes, the tire pressure values indicated by a pressure gage are higher than those shown by the on-board computer. In this case, do not reduce the tire pressures.

If radio transmitting equipment (e.g. wireless headphones, two-way radios) is operated inside the vehicle or in the vicinity of the vehicle, this can interfere with the operation of the tire pressure monitor.

Checking the tire pressure electronically on vehicles with steering wheel buttons

You can only check the tire pressure electronically on vehicles with steering wheel buttons.

Using the steering wheel buttons

- ▶ Turn the key to position **2** in the ignition lock.
- ▶ Press the  or  button to select the **Service** menu.
- ▶ Use the  or  button to select **Tire Pressure**.
- ▶ Press  to confirm.
The current tire pressure of each wheel is shown in the display.

If the vehicle has been parked for over 20 minutes, the **Tire pressure will be displayed after driving a few minutes** message appears.

After a teach-in period, the tire pressure monitor automatically detects new wheels or new sensors. As long as a clear allocation of the tire pressure value to the individual wheels is not possible, the **Tire Pressure Monitor Active** message is shown instead of the tire pressure display. The tire pressures are already being monitored.

Tire pressure monitor warning messages

If the tire pressure monitor detects a loss in pressure in one or more tires, a warning message is shown in the display. The  warning lamp lights up.

Vehicles without steering wheel buttons

- If the **Correct Tire Pressure** message is shown in the display, the tire pressure in at least one tire is too low. The tire pressure must be corrected at the next opportunity.
- If the **Check Tire Pressure Soon** message is shown in the display, the tire pressure in one or more tires has dropped significantly. The tires must be checked.
- If the **Warning Tire Malfunc.** message is shown in the display, the tire pressure in one or more tires has dropped suddenly. The tires must be checked.

Vehicles with steering wheel buttons

- If the **Adjust Tire Pressure** message is shown in the display, the tire pressure in at least one tire is too low. The tire pressure must be corrected at the next opportunity.
- If the **Check Tires** message is shown in the display, the tire pressure in one or more tires has dropped significantly. The tires must be checked.
- If the **Warning Tire Malfunction** message is shown in the display, the tire pressure in one or more tires has dropped suddenly. The tires must be checked.

Always read and follow the instructions and safety notes related to the display messages, which can be found in the "Tires" section.

- for vehicles without steering wheel buttons (> page 201)
- for vehicles with steering wheel buttons (> page 217)

Vehicles with steering wheel buttons: if the wheel positions on the vehicle are rotated, the tire pressures may be displayed for the wrong

positions for a short time. This is rectified after a few minutes of driving; the tire pressures are then displayed for the correct positions.



Restarting the tire pressure monitor

General notes

When you restart the tire pressure monitor, all existing warning messages are deleted and the warning lamp goes out. The monitor uses the currently set tire pressures as the reference values for monitoring. In most cases, the tire pressure monitor will automatically detect the new reference values after you have changed the tire pressures. However, you can also define reference values manually as described here. The tire pressure monitor then monitors the new tire pressure values.

Vehicles without steering wheel buttons

The vehicle must be stationary. Use the buttons in the instrument cluster.

- ▶ Turn the key to position **2** in the ignition lock.
- ▶ Press  to select the **Tire Pressure** menu.
- ▶ Press  to confirm.
The display shows the **Monitoring Active** message.
- ▶ Press  to confirm.
The display shows the **Tire Pressure OK?** message.

If you wish to confirm the restart:







- ▶ Press the  button.
The display shows the distance menu.
After you have driven for a few minutes, the system checks whether the current tire pressures are within the specified range. The new tire pressures are then accepted as reference values and are monitored.

If you wish to cancel the restart:

- ▶ Press .
The display shows the tire pressure menu.
The tire pressure values stored at the last restart will continue to be monitored.

Vehicles with steering wheel buttons

Using the steering wheel buttons

- ▶ Make sure that the tire pressure of all four wheels is set correctly for the current operating conditions. When doing so, observe the notes under "Tire pressure" (> page 280).
- ▶ Turn the key to position **2** in the ignition lock.
- ▶ Press  or  to select the **Service** menu.
- ▶ Press  or  to select the **Tire Pressure** submenu.
- ▶ Press  to confirm.
The display shows either the current tire pressure for the individual tires, or the **Tire pressure will be displayed after driving a few minutes** message.
- ▶ Press the  button.
The display shows the **Use Current Pressures as New Reference Values:** message.

If you wish to confirm the restart:

- ▶ Press the  button.
The display shows the **Tire Press. Monitor Restarted** message.
After you have driven for a few minutes, the system checks whether the current tire pressures are within the specified range. The new tire pressures are then accepted as reference values and are monitored.

If you wish to cancel the restart:

- ▶ Press the  button.
The tire pressure values stored at the last restart will continue to be monitored.

Tire pressure tables

Vehicles with a gross vehicle weight of 6,724 lbs (3.05 t)

! The pressure difference between tires on any one axle must be no greater than 10 kPa (0.1 bar / 1.5 psi).

The following tire pressure values apply to vehicles with:

- a gross vehicle weight of **6,724 lbs (3.05 t)**
- a gross axle weight rating of **3,418 lbs (1,550 kg)** on the rear axle and
- the tires referred to under "Wheel and tire combinations" (> page 300)

Always observe the notes under "Information on tire pressures" (> page 280).

The tire pressure for the **spare wheel** is 340 kPa (3.4 bar/49 psi).

Tire size	Partially laden vehicle		Fully laden vehicle	
	Front axle	Rear axle	Front axle	Rear axle
225/55 R 17 XL	270 kPa (2.7 bar/ 39 psi)	270 kPa (2.7 bar/ 39 psi)	300 kPa (3.0 bar/ 44 psi)	310 kPa (3.1 bar/45 psi)

Loading the vehicle

Instruction labels for tires and loads

WARNING

Overloaded tires can overheat, causing a blowout. Overloaded tires can also impair the steering and driving characteristics and lead to brake failure. There is a risk of accident.

Observe the load rating of the tires. The load rating must be at least half of the GAWR of your vehicle. Never overload the tires by exceeding the maximum load.



Example: Tire and Loading Information placard on the B-pillar, driver's side

Two instruction labels on your vehicle show the maximum possible load.

- (1) Tire and Loading Information placard ① is on the B-pillar on the driver's side. Tire and Loading Information placard ① shows the permissible number of occupants and the maximum permissible load of the vehicle. It also contains details of the tire sizes and corresponding pressures for tires mounted at the factory.
- (2) The vehicle identification plate is on the B-pillar on the driver's side. The vehicle identification plate informs you of the permissible gross weight. It is made up of the vehicle weight, all vehicle occupants, the fuel and the cargo. You can also find information about the maximum Gross Axle Weight Rating on the front and rear axle. The maximum gross axle weight rating is the maximum weight that can be carried by one axle (front or rear axle). Do not exceed the permissible gross weight or the maximum gross axle weight rating for the front or rear axle.

Tire and Loading Information placard

Maximum permissible gross weight

TIRE AND LOADING INFORMATION RENSEIGNEMENTS SUR LES PNEUS ET LE CHARGEMENT			
SEATING CAPACITY NOMBRE DE PLACES	TOTAL X	FRONT AVANT X	REAR ARRIÈRE X
The combined weight of occupants and cargo should never exceed XXXX kg or XXXX lbs. Le poids total des occupants et du chargement ne doit jamais dépasser XXXX kg ou XXXX lb.			
TIRE PNEU	SIZE DIMENSIONS	COLD TIRE PRESSURE PRESSION DES PNEUS À FROID	SEE OWNER'S MANUAL FOR ADDITIONAL INFORMATION (P. 2)
FRONT AVANT	XXX/XX R XX	XXXkPa, XXPSI	VOIR LE MANUEL DE L'USAGER POUR PLUS DE RENSEIGNEMENTS
REAR ARRIÈRE	XXX/XX R XX	XXXkPa, XXPSI	
SPARE DE SECOURS	XXX/XX R XX	XXXkPa, XXPSI	

N40.00-Z043-31

- ① Maximum number of seats
 - ② Maximum permissible gross weight
- Specification for maximum permissible gross weight ② is listed in the Tire and Loading Information placard: "The gross weight of occupants and luggage must not exceed XXX kilograms or XXX lbs."

The gross weight of all vehicle occupants, cargo, luggage and trailer load/noseweight (if applicable) must not exceed the specified value.

i The details on the Tire and Loading Information placard illustration are only an example. The maximum permissible gross weight is vehicle-specific and may deviate from the data shown here. The maximum permissible gross weight that applies to your vehicle can be found on your vehicle's Tire and Loading Information placard.

Number of seats

TIRE AND LOADING INFORMATION RENSEIGNEMENTS SUR LES PNEUS ET LE CHARGEMENT			
SEATING CAPACITY NOMBRE DE PLACES	TOTAL X	FRONT AVANT X	REAR ARRIÈRE X
The combined weight of occupants and cargo should never exceed XXXX kg or XXXX lbs. Le poids total des occupants et du chargement ne doit jamais dépasser XXXX kg ou XXXX lb.			
TIRE PNEU	SIZE DIMENSIONS	COLD TIRE PRESSURE PRESSION DES PNEUS À FROID	SEE OWNER'S MANUAL FOR ADDITIONAL INFORMATION (P. 2)
FRONT AVANT	XXX/XX R XX	XXXkPa, XXPSI	VOIR LE MANUEL DE L'USAGER POUR PLUS DE RENSEIGNEMENTS
REAR ARRIÈRE	XXX/XX R XX	XXXkPa, XXPSI	
SPARE DE SECOURS	XXX/XX R XX	XXXkPa, XXPSI	

N40.00-Z043-31

- ① Maximum number of seats
- ② Maximum permissible gross weight

Maximum number of seats ① determines the maximum number of occupants allowed to travel in the vehicle. This information can be found on the Tire and Loading Information placard.

i The details on the Tire and Loading Information placard illustration are only an example. The number of seats is vehicle-specific and can differ from the details shown. The number of seats in your vehicle can be found on the Tire and Loading Information placard.

Determining the maximum load

Individual steps

The following steps have been developed as required of all manufacturers under Title 49, Code of U.S. Federal Regulations, Part 575 in accordance with the "National Traffic and Motor Vehicle Safety Act of 1966".

- **Step 1:** Locate the statement "The combined weight of occupants and cargo should never exceed XXX kg or XXX lbs." on your vehicle's Tire and Loading Information placard.
- **Step 2:** Determine the combined weight of the driver and passengers that will be traveling in your vehicle.
- **Step 3:** Subtract the combined weight of the driver and passengers from XXX kilograms or XXX lbs.
- **Step 4:** The resulting figure equals the available amount of cargo and luggage load capacity. For example, if the "XXX" amount equals 1400 lbs and there will be five 150-pound passengers in your vehicle, the amount of available cargo and luggage load capacity is 650 lbs (1400 - 750 (5 x 150) = 650 lbs).
- **Step 5:** Determine the combined weight of luggage and cargo being loaded on the vehicle. For reasons of safety, that weight must not exceed the available cargo and luggage cargo capacity calculated in step 4.
- **Step 6 (if applicable):** If your vehicle is towing a trailer, load from the trailer will be transferred to your vehicle. Please consult the Tire and Loading Information placard, to determine how this reduces the available cargo and luggage load capacity of your vehicle.

Example: Steps 1 to 3

The following table shows examples of how to calculate total load and cargo capacities with varying seating configurations and number and size of occupants. The following examples use a maximum load of 1500 lbs (680 kg). **This is for illustration purposes only.** Make sure you are using the actual load limit for your vehicle stated on your vehicle's Tire and Loading Information placard .

		Example 1	Example 2	Example 3
Step 1	Combined maximum weight of occupants and cargo (data from the Tire and Loading Information placard)	1500 lbs (680 kg)	1500 lbs (680 kg)	1500 lbs (680 kg)

		Example 1	Example 2	Example 3
Step 2	Number of people in the vehicle (driver and occupants)	5	3	1
	Distribution of the occupants	Front: 2 Rear: 3	Front: 1 Rear: 2	Front: 1
	Weight of the occupants	Occupant 1: 150 lbs (68 kg) Occupant 2: 180 lbs (82 kg) Occupant 3: 160 lbs (73 kg) Occupant 4: 140 lbs (63 kg) Occupant 5: 120 lbs (54 kg)	Occupant 1: 200 lbs (91 kg) Occupant 2: 190 lbs (86 kg) Occupant 3: 150 lbs (68 kg)	Occupant 1: 150 lbs (68 kg)
	Gross weight of all occupants	750 lbs (340 kg)	540 lbs (245 kg)	150 lbs (68 kg)

		Example 1	Example 2	Example 3
Step 3	Permissible load and trailer load/nose-weight (maximum permissible gross weight from the Tire and Loading Information placard minus the gross weight of all occupants)	1500 lbs (680 kg) - 750 lbs (340 kg) = 750 lbs (340 kg)	1500 lbs (680 kg) - 540 lbs (245 kg) = 960 lbs (435 kg)	1500 lbs (680 kg) - 150 lbs (68 kg) = 1350 lbs (612 kg)

The greater the combined weight of the occupants, the lower the maximum luggage load. You can find further information under: "Trailer tow hitch" (> page 314).

Vehicle identification plate

Even if you have calculated the total load carefully, you should still make sure that the permissible gross weight and the gross axle weight rating of your vehicle are not exceeded. This data can be found on the vehicle identification plate on the B-pillar of your vehicle (▷ page 303).

Permissible gross vehicle weight: the gross weight of the vehicle, all occupants, load and trailer load/noseweight (if applicable) must not exceed the permissible gross vehicle weight.

Gross axle weight rating: the maximum permissible load that can be carried by one axle (front or rear axle).

To ensure that your vehicle does not exceed the maximum permissible values (gross vehicle weight and maximum gross axle weight rating), have your loaded vehicle (including driver, occupants, load, and full trailer load if applicable) weighed on a suitable vehicle weighbridge.

Trailer load/noseweight

The trailer load/noseweight affects the gross weight of the vehicle. If a trailer is attached, the trailer load/noseweight is included in the load along with occupants and luggage. The trailer load/noseweight is usually approximately 10% of the gross weight of the trailer and its load.

What you should know about wheels and tires

Tire labeling

Tire labeling

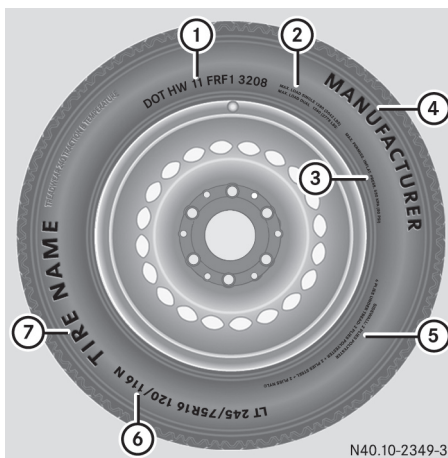

- ① DOT, Tire Identification Number (▷ page 293)
- ② Maximum tire load (▷ page 293)
- ③ Maximum tire pressure (▷ page 284)
- ④ Manufacturer
- ⑤ Tire material (▷ page 294)
- ⑥ Tire size designation, load-bearing capacity and speed index (▷ page 291)
- ⑦ Tire name

The markings described above are on the tire in addition to the tire name (sales designation) and the manufacturer's name.

- i** Tire data is vehicle-specific and may deviate from the data in the example.

Tire size designation, load bearing index and speed index

WARNING

Exceeding the stated tire load-bearing capacity and the approved maximum speed could lead to tire damage or the tire bursting. There is a risk of accident.

Therefore, only use tire types and sizes approved for your vehicle model. Observe the

tire load rating and speed rating required for your vehicle.

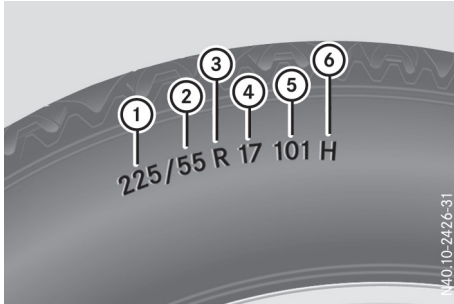

- ① Tire width
- ② Nominal aspect ratio in %
- ③ Tire code
- ④ Rim diameter
- ⑤ Load bearing index
- ⑥ Speed index

Tire width: tire width ① shows the nominal tire width in millimeters.

Aspect ratio: aspect ratio ② is the size ratio between the tire height and tire width and is shown in percent. The aspect ratio is calculated by dividing the tire width by the tire height.

Tire code: tire code ③ specifies the tire type. "R" represents radial tires. "D" represents diagonal tires, "B" represents diagonal radial tires.

Rim diameter: rim diameter ④ is the diameter of the bead seat, not the diameter of the rim flange. The rim diameter is specified in inches (in).

Load-bearing index: load-bearing index ⑤ is a numerical code that specifies the maximum load-bearing capacity of a tire.

Do not overload the tires by exceeding the specified load limit. The maximum permissible load can be found on the vehicle's Tire and Loading Information placard on the B-pillar on the driver's side (> page 288).

Example:

The load-bearing index 101 indicates a maximum load of 1819 lb (825 kg) for the tire. If two load-bearing indices are specified, the first number specifies the load-bearing capacity for single tires, the second the load-bearing capacity for twin tires. For further information on the maximum tire load in kilograms and pounds, see (> page 293).

For further information on the load-bearing index, see "Load index" (> page 293).

Speed rating: speed rating ⑥ specifies the approved maximum speed of the tire.

Regardless of the speed index always observe the speed limits. Drive carefully and adapt your driving style to the traffic conditions.

i Tire data is vehicle-specific and may deviate from the data in the example.

Index	Speed rating
Q	up to 100 mph (160 km/h)
R	up to 106 mph (170 km/h)
S	up to 112 mph (180 km/h)
T	up to 118 mph (190 km/h)
H	up to 130 mph (210 km/h)
V	up to 149 mph (240 km/h)
W	up to 168 mph (270 km/h)
Y	up to 186 mph (300 km/h)

i Not all tires that have the M+S identification offer the driving characteristics of winter tires. In addition to the M+S marking, winter tires also have the  snowflake symbol on the tire wall. Tires with this marking fulfill the requirements of the Rubber Manufacturers Association (RMA) and the Rubber Association of Canada (RAC) regarding the tire traction on snow. They have been especially developed for driving on snow.

Further information on the reading of tire information can be obtained at any qualified specialist workshop.

Load index



Load index (example)

In addition to the load-bearing index, load rating ① may be imprinted after the letters that identify speed rating on the sidewall of the tire (▷ page 291).

- If no specification is given: no text (as in the example above), represents a standard load (SL) tire
- RF or Reinforced: represents a reinforced tire. Alternatively, depending on the manufacturer, the designation XL (Extra Load) can be used.
- Light Load: represents a light load tire
- C, D, E: represents a load range that depends on the maximum load that the tire can carry at a certain pressure

i Tire data is vehicle-specific and may deviate from the data in the example.

Maximum tire load

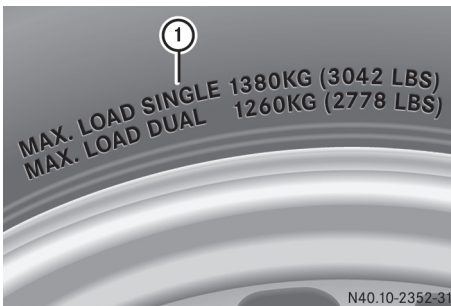

Example: maximum tire load

Maximum tire load ① is the maximum permissible weight for which the tire is approved.

Do not overload the tires by exceeding the specified load limit. The maximum permissible

load can be found on the vehicle's Tire and Loading Information placard on the B-pillar on the driver's side (▷ page 288).

i The actual values for tires are specific to each vehicle and may deviate from the values in the illustration.

DOT, Tire Identification Number (TIN)

U.S. tire regulations stipulate that every tire manufacturer or retreader must imprint a TIN in or on the sidewall of each tire produced.

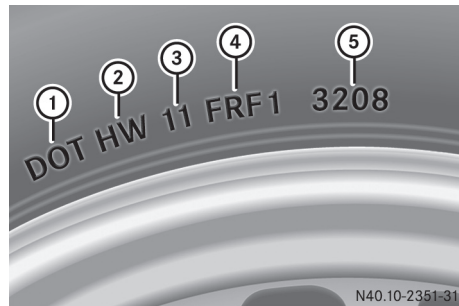

The TIN is a unique identification number. The TIN enables the tire manufacturers or retreaders to inform purchasers of recalls and other safety-relevant matters. It makes it possible for the purchaser to easily identify the affected tires.

The TIN is made up of manufacturer identification code ②, tire size ③, tire type code ④ and manufacturing date ⑤.

DOT (Department of Transportation): tire symbol ① indicates that the tire complies with the requirements of the U.S. Department of Transportation.

Manufacturer identification code: manufacturer identification code ② provides details on the tire manufacturer. New tires have a code with two symbols. Retreaded tires have a code with four symbols.

Further information about retreaded tires (▷ page 277).

Tire size: identifier ③ describes the tire size.

Tire type code: tire type code ④ can be used by the manufacturer as a code to describe specific characteristics of the tire.

Date of manufacture: date of manufacture ⑤ provides information about the age of a tire. The first and second positions represent the week of manufacture, starting with "01" for the first calendar week. Positions three and four represent



the year of manufacture. For example, a tire that is marked with "3208" was manufactured in week 32 in 2008.

- i** Tire data is vehicle-specific and may deviate from the data in the example.

Tire characteristics



This information describes the type of tire cord and the number of layers in sidewall ① and under tire tread ②.

- i** Tire data is vehicle-specific and may deviate from the data in the example.

Definitions for tires and loading

Tire structure and characteristics

Describes the number of layers or the number of rubber-coated belts in the tire tread and the tire wall. These consist of steel, nylon, polyester, and other materials.

Bar

Metric unit for tire pressure. 14.5038 pounds per square inch (psi) and 100 kilopascals (kPa) are the equivalent of 1 bar.

DOT (Department of Transportation)

DOT marked tires fulfill the requirements of the United States Department of Transportation.

Average weight of vehicle occupants

The number of occupants for which the vehicle is designed multiplied by 68 kilograms (150 lbs).

Uniform Tire Quality Grading Standards

A uniform standard to grade the quality of tires with regard to tread quality, traction and temperature characteristics. The quality grading assessment is made by the manufacturer following specifications from the U.S government. The quality grade of a tire is imprinted on the sidewall of the tire.

Recommended tire pressure

The recommended tire pressures are the pressures specified for the tires mounted on the vehicle at the factory.

The tire and load information table¹ contains the recommended tire pressures for cold tires, the maximum permissible load and the maximum permissible vehicle speed.

The tire pressure table contains the recommended tire pressure for cold tires under various operating conditions, i.e. loading and/or speed of the vehicle.

Increased vehicle weight due to optional equipment

The combined weight of all standard and optional equipment available for the vehicle, regardless of whether it is actually installed on the vehicle or not.

Wheel rim

The part of the wheel on which the tire is mounted.

GAWR (Gross Axle Weight Rating)

GAWR is the maximum gross axle weight rating. The actual load on an axle must never exceed the gross axle weight rating. You can find the maximum gross axle weight rating on the B-pillar on the driver's side (▷ page 303).

Speed index

The speed index is part of the tire identification. It specifies the speed range for which the tire is approved.

GTW (Gross Trailer Weight)

GTW is the total of weight of a trailer and the weight of the load, accessories etc. on the trailer.

¹ Only for vehicles with a gross weight of less than 10,000 lbs (4536 kg).

GVW (Gross Vehicle Weight)

The gross vehicle weight includes the weight of the vehicle including fuel, tools, spare wheel, accessories installed, occupants, luggage and the drawbar noseweight if applicable. The gross vehicle weight must never exceed the permissible gross weight (GVWR) specified on the B-pillar on the driver's side (▷ page 303).

GVWR (Gross Vehicle Weight Rating)

The GVWR is the maximum permitted gross weight of the fully laden vehicle (weight of the vehicle including all accessories, occupants, fuel, luggage and the drawbar noseweight if applicable). The permissible gross weight is specified on the vehicle identification plate on the B-pillar on the driver's side (▷ page 303).

Maximum weight of the laden vehicle

The maximum weight is the sum of:

- the curb weight of the vehicle
- the weight of the accessories
- the load limit
- the weight of the factory installed optional equipment

Kilopascal (kPa)

Metric unit for tire pressure. 6.9 kPa are the equivalent of 1 psi. Another tire pressure unit is bar. 100 kilopascals (kPa) are the equivalent of 1 bar.

Load index

In addition to the load bearing index, a load index can be stamped onto the sidewall of the tire. It specifies the load-bearing capacity of the tire more precisely.

Curb weight

The weight of a vehicle with standard equipment including the maximum filling capacity of fuel, oil, and coolant. It also includes the air-conditioning system and optional equipment if these are installed on the vehicle, but does not include passengers or luggage.

Maximum tire load

The maximum tire load in kilograms or pounds is the maximum weight for which a tire is approved.

Maximum permissible tire pressure

Maximum permissible tire pressure for one tire.

Maximum load on one tire

Maximum load on one tire. This is calculated by dividing the maximum axle load of one axle by two.

PSI (Pounds per square inch)

Standard unit of measurement for tire pressure.

Aspect ratio

Relationship between tire height and width in percent.

Tire pressure

Pressure inside the tire applying an outward force to every square inch of the tire's surface. Tire pressure is specified in pounds per square inch (psi), in kilopascal (kPa) or in bar. Tire pressure should only be corrected when the tires are cold.

Cold tire pressure

The tires are cold:

- if the vehicle has been parked for at least three hours without direct sunlight on the tires, and
- if the vehicle has not been driven further than 1 mile (1.6 km)

Tire tread

The part of the tire that comes into contact with the road.

Tire bead

The tire bead ensures that the tire sits securely on the wheel. There are several steel wires in the bead to prevent the tire from coming loose from the wheel rim.

Sidewall

The part of the tire between the tread and the tire bead.

Weight of optional extras

The combined weight of those optional extras that weigh more than the replaced standard parts and more than 2.3 kg (5 lbs). These optional extras, such as high-performance brakes, a roof rack or a high-performance battery, are not included in the curb weight and the weight of the accessories.

TIN (Tire Identification Number)

A unique identification number which can be used by a tire manufacturer to identify tires, for example for a product recall, and thus identify the purchasers. The TIN is composed of the manufacturer identification code, tire size, tire model code and manufacturing date.

Load bearing index

The load bearing index (also load index) is a code that contains the maximum load bearing capacity of a tire.

Traction

Traction is the result of friction between the tires and the road surface.

TWR (permissible trailer drawbar load)

The TWR is the maximum permissible weight that may act on the ball coupling of the trailer tow hitch.

Wear indicator

Narrow bars (tread wear bars) that are distributed over the tire tread. If the tire tread is level with the bars, the wear limit of $\frac{1}{16}$ in (1.6 mm) has been reached.

Distribution of the vehicle occupants

The distribution of vehicle occupants over designated seat positions in a vehicle.

Maximum permissible payload weight

Nominal load and goods/luggage load plus 68 kg (150 lbs) multiplied by the number of seats in the vehicle.

Changing wheels**Rotating the wheels** **WARNING**

Interchanging the front and rear wheels may severely impair the driving characteristics if the wheels or tires have different dimensions. The wheel brakes or suspension components may also be damaged. There is a risk of accident.

Rotate front and rear wheels only if the wheels and tires are of the same dimensions.

 On vehicles equipped with a tire pressure monitor, electronic components are located in the wheel.

Tire-mounting tools should not be used near the valve. This could damage the electronic components.

Only have tires changed at a qualified specialist workshop.

Always observe the instructions and safety notes under "Mounting a wheel" (▷ page 297).

The wear patterns on the front and rear tires differ, depending on the operating conditions. Rotate the wheels before a clear wear pattern has formed on the tires. Front tires typically wear more on the shoulders and the rear tires in the center.

If your vehicle's tire configuration allows, you can rotate the tires according to the intervals in the tire manufacturer's warranty book in your vehicle documents. If no warranty book is available, the tires should be rotated every 3,000 to 6,000 miles (5,000 to 10,000 km) or earlier if tire wear requires. Do not change the direction of rotation.

Clean the contact surfaces of the wheel and the brake disc thoroughly every time a wheel is rotated. Avoid oily or greasy cleaning agents.

Check the tire pressure and reactivate the tire pressure monitor if necessary.

Direction of rotation

Tires with a specified direction of rotation have additional benefits, e.g. if there is a risk of hydroplaning. You will only gain these benefits if the correct direction of rotation is observed.

An arrow on the sidewall of the tire indicates its correct direction of rotation.

You may mount a spare wheel against the direction of rotation. Observe the time restriction on use as well as the speed limitation specified on the spare wheel.

Storing wheels

Store wheels that are not being used in a cool, dry and preferably dark place. Protect the tires from contact with oil, grease and fuel.

Mounting a wheel

Vehicle preparation

- ▶ Stop the vehicle as far away as possible from traffic and on a level, firm and non-slip surface.
- ▶ If your vehicle poses a risk to approaching traffic, switch on the hazard warning lamps.
- ▶ Apply the parking brake.
- ▶ Turn the front wheels to the straight-ahead position.
- ▶ Shift the transmission to position **P**.
- ▶ Switch off the engine.
- ▶ Passengers should leave the vehicle. Make sure that the passengers are not endangered as they do so.
- ▶ Make sure that no one is near the danger area while the wheel is being changed. Anyone who is not directly assisting in the wheel change should, for example, stand behind the barrier.
- ▶ Place the warning triangle or warning lamp at a suitable distance.
Observe the legal requirements on the correct use of the warning triangle or warning lamp for the country in which you are currently driving
- ▶ Secure the vehicle to prevent it from rolling away.
Observe the safety notes on parking under "Driving and parking" (> page 133)
- ▶ **On level terrain:** place chocks or other suitable objects under the front and rear of the wheel that is diagonally opposite the wheel to be changed.
- ▶ **On slight inclines:** place chocks or other suitable objects under the wheels on the front and rear axles opposite the wheel to be changed.
- ▶ If included in the vehicle equipment, take the tire-changing tool kit out of the vehicle tool kit (> page 270).
Apart from some country-specific variants, vehicles are not equipped with tire-changing tools. Some tools for changing a wheel are specific to the vehicle. Consult a qualified specialist workshop for more information on which tools are required to perform a wheel change on your vehicle.
- ▶ If included in the vehicle equipment, remove the spare wheel from the spare wheel bracket

(> page 301). Observe the safety notes listed under "Spare wheel" (> page 301).

- ▶ Carefully remove the hub caps.

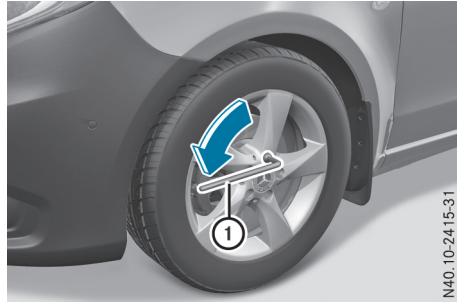

- ▶ Using lug wrench ①, loosen the wheel bolts on the wheel to be changed counter-clockwise by about one full turn. Do not remove the wheel bolts.

Raising the vehicle

WARNING

If you do not position the jack correctly at the appropriate jacking point of the vehicle, the jack could tip over with the vehicle raised. There is a risk of injury.

Only position the jack at the appropriate jacking point of the vehicle. The base of the jack must be positioned vertically, directly under the jacking point of the vehicle.

WARNING

On uphill and downhill slopes, the jack could tip over with the vehicle raised. There is a risk of injury.

Do not change wheels on uphill or downhill gradients. Notify a qualified specialist workshop.

- ▶ **!** Only position the jack on the jacking points intended for this purpose. You could otherwise damage the vehicle.

Observe the following when raising the vehicle:

- To raise the vehicle, only use the vehicle-specific jack that has been tested and approved by Mercedes-Benz. If the jack is used incor-

rectly, it could tip over while the vehicle is raised.

- The vehicle's jack is intended only to raise the vehicle for a short time when changing a wheel. It is not suited for performing maintenance work under the vehicle.
- Avoid changing the wheel on uphill and downhill slopes.
- Before raising the vehicle, secure it from rolling away by applying the parking brake and inserting wheel chocks. Never disengage the parking brake while the vehicle is raised.
- The jack must be placed on a firm, flat and non-slip surface. On a loose surface, a large, load-bearing underlay must be used. On a slippery surface, a non-slip underlay must be used, e.g. rubber mats.
- Make sure that the distance between the underside of the tires and the ground does not exceed 1.2 in(3 cm).
- Never place your hands or feet under the raised vehicle.
- Never lie under the raised vehicle.
- Never start the engine when the vehicle is raised.
- Never open or close a door or the tailgate/door when the vehicle is raised.
- Make sure that no persons are present in the vehicle when the vehicle is raised.

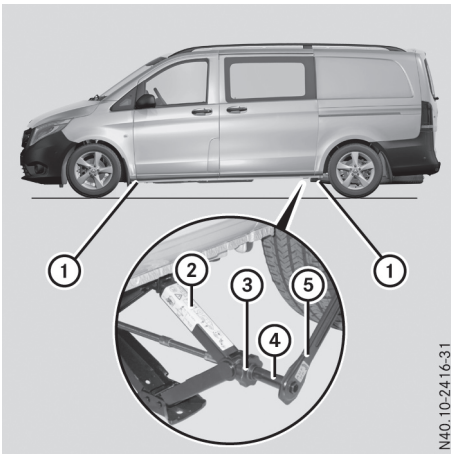

N40.10-2416-31

Jacking points ① (rubber stoppers) are located just behind the front wheel arches and just in front of the rear wheel arches.

- ▶ Place jack ② beneath corresponding jacking points ①.
- ▶ Turn handwheel ③ until jack plate ② sits securely on jacking point ①.
- ▶ Make sure the base of jack ② is positioned vertically beneath jacking point ①.
- ▶ Assemble adapter ④ and ratchet ⑤ from the vehicle tool kit.
- ▶ Place adapter ④ and ratchet ⑤ on the hexagon nut of jack ② so that the lettering **AB/DOWN** is visible.
- ▶ Turn ratchet ⑤ in the **AUF/UP** direction until the tire is a maximum of 3 cm off the ground. When doing so, jack ② may move to one of the side support surfaces.

Removing a wheel

! Do not place wheel bolts in sand or on a dirty surface. The bolt and wheel hub threads could otherwise be damaged when you screw them in.

- ▶ Unscrew the wheel bolts.
- ▶ Remove the wheel.

Mounting a new wheel

! WARNING

Oiled or greased wheel bolts or damaged wheel bolts/hub threads can cause the wheel bolts to come loose. As a result, you could lose a wheel while driving. There is a risk of accident.

Never oil or grease wheel bolts. In the event of damage to the threads, contact a qualified specialist workshop immediately. Have the damaged wheel bolts or hub threads replaced/renewed. Do not continue driving.

! WARNING

If you tighten the wheel bolts or wheel nuts when the vehicle is raised, the jack could tip over. There is a risk of injury.

Only tighten the wheel bolts or wheel nuts when the vehicle is on the ground.

Always observe the instructions and safety notes on "Changing a wheel" (▷ page 296).

Only use wheel bolts that have been designed for the wheel and the vehicle. For safety reasons, Mercedes-Benz recommends that you only use wheel bolts which have been approved for Mercedes-Benz vehicles and the respective wheel.

! On vehicles equipped with a tire pressure monitor, electronic components are located in the wheel.

Tire-mounting tools should not be used near the valve. This could damage the electronic components.

Only have tires changed at a qualified specialist workshop.

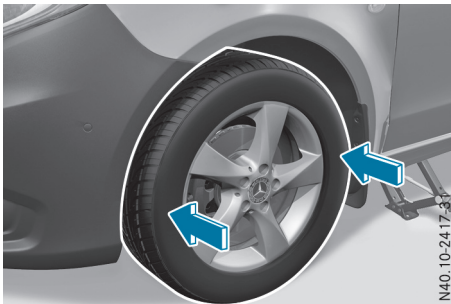

- ▶ Clean the wheel and wheel hub contact surfaces.
- ▶ Slide the new wheel onto the wheel hub and push it on.
- ▶ Screw in the wheel bolts and tighten them lightly.

Lowering the vehicle

⚠ WARNING

The wheels could work loose if the wheel nuts and bolts are not tightened to the specified tightening torque. There is a risk of accident.

Have the tightening torque immediately checked at a qualified specialist workshop after a wheel is changed.

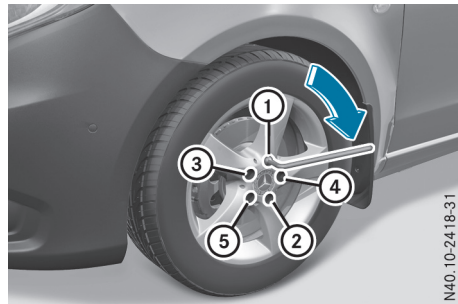

①—⑤ Wheel bolts

- ▶ Place the adapter and the ratchet on the hexagon head nut of the jack such that the lettering **AB/DOWN** is visible.
- ▶ Turn the ratchet in the **AB/DOWN** direction until the vehicle is once again standing firmly on the ground.
- ▶ Put the jack aside.
- ▶ Tighten the wheel bolts evenly in a crosswise pattern in the sequence indicated (① to ⑤). Tighten the wheel bolts to the following tightening torques:
 - Steel wheel **147 lb-ft (200 Nm)**
 - Alloy wheel **133 lb-ft (180 Nm)**
- ▶ Turn the jack back to its out-of-use position.
- ▶ Stow the jack and the rest of the tire-change tool kit in the vehicle again.
- ▶ Wheel with hub cap: position the opening for the tire valve in the hub cap over the tire valve.
- ▶ Push the edge of the hub cap with both hands against the wheel until it clicks into place. Make sure the hub cap retaining catches engage on the steel wheel.
- ▶ If included in the vehicle equipment, secure the faulty wheel in the spare wheel bracket (▷ page 301). Otherwise, transport the faulty wheel in the cargo compartment.
- ▶ Check the tire pressure of the newly mounted wheel and adjust it if necessary. Observe the recommended tire pressure (▷ page 280). Vehicles with the tire pressure monitor system: all mounted wheels must be equipped with functioning sensors.
- ▶ Retighten the wheel bolts or wheel nuts to the specified tightening torque after the vehicle has been driven for 30 miles (50 km).

When using a wheel/spare wheel with a new or newly painted wheel rim, have the wheel bolts/nuts retightened again after approximately 600 to 3,000 miles (1,000 to 5,000 km). Observe the specified tightening torque.

Wheel and tire combination

General notes

! Retreaded tires are neither tested nor recommended by Mercedes-Benz, since previous damage cannot always be detected on retreaded tires. As a result, Mercedes-Benz cannot guarantee vehicle safety if retreaded tires are mounted. Do not mount used tires if you have no information about their previous usage.

! For safety reasons, Mercedes-Benz recommends that you only use tires, wheels and accessories which have been specially approved by Mercedes-Benz for your vehicle. These tires have been specially adapted for use with the driving safety systems, such as ABS or ESP®.

Only use tires, wheels or accessories tested and approved by Mercedes-Benz. Certain characteristics, e.g. handling, vehicle noise emissions or fuel consumption, may otherwise be adversely affected. In addition, when driving with a load, tire dimension variations could cause the tires to come into contact with the bodywork and axle components. This

could result in damage to the tires or the vehicle.

Mercedes-Benz accepts no liability for damage resulting from the use of tires, wheels or accessories other than those tested and approved.

Further information on wheels, tires and approved combinations can be obtained from any qualified specialist workshop.

! Large wheels: the lower the section width for a certain wheel size, the lower the ride comfort is on poor road surfaces. Roll comfort and suspension comfort are reduced and the risk of damage to the wheels and tires as a result of driving over obstacles increases.

You will find a table with the recommended tire pressures for various vehicle loads on the inside of your vehicle's fuel filler flap or under "Tire pressure tables" (> page 288). You can find further information under "Tire pressure" (> page 280).

Check tire pressures regularly and only when the tires are cold.

Notes on the vehicle equipment – always equip the vehicle:

- with tires of the same size across an axle (left/right)
- with the same type of tires on all wheels at a given time (summer tires, winter tires)

i Not all wheel/tire combinations can be installed at the factory in all countries.

Tires

R 17

Tires	Steel wheels
225/55 R17 RF (XL) 101V	6.5 J x 17 H2 ET 50
225/55 R17 RF (XL) 101H	6.5 J x 17 H2 ET 50

R 17

Tires	Alloy wheels
225/55 R17 RF (XL) 101V	7 J x 17 H2 ET 51
225/55 R17 RF (XL) 101H	7 J x 17 H2 ET 51

Spare wheel

Important safety notes

WARNING

Wheel and tire dimensions as well as the type of tire can vary between the spare wheel and the wheel to be replaced. When the spare wheel is mounted, driving characteristics may be severely affected. There is a risk of an accident.

In order to reduce risks:

- you should therefore adapt your driving style and drive carefully.
- never mount more than one spare wheel that differs from the wheel to be replaced.
- only use a spare wheel that differs from the wheel to be replaced for a short time.
- do not deactivate ESP®.
- have a spare wheel that differs from the wheel that has been changed replaced at the nearest qualified specialist workshop. You must observe the correct wheel and tire dimensions as well as the wheel type.

When using a spare wheel of a different size, do not exceed the maximum permissible speed of 50 mph (80 km/h).

General notes

The procedure for mounting the spare wheel is described in "Mounting a wheel" (▷ page 297). The following should be checked regularly, particularly prior to long journeys:

- the tire pressure of the spare wheel, which should then be corrected if necessary (▷ page 280)
- the fastenings of the spare wheel bracket

The spare wheel is located either in the left rear compartment or in a spare wheel bracket under the vehicle.

Replace the tires after six years at the latest, regardless of wear. This also applies to the spare wheel.

Vehicles with tire pressure monitor: the spare wheel is not equipped with a sensor for monitoring tire pressure. If you have installed a

spare wheel, the tire pressure monitor will not function for this wheel. The system may continue to show the tire pressure of the wheel that has been removed for a few minutes. The value displayed for the position where the spare wheel is installed is not the same as the current tire pressure of the spare wheel.

When you are driving with the spare wheel mounted, the tire pressure monitor cannot function reliably. Only restart the tire pressure monitor when the defective wheel has been replaced with a new wheel and sensor.

More Information can be found under "Tire pressure monitor" (▷ page 284).

Removing and installing the spare wheel

Spare wheel under the rear of the vehicle

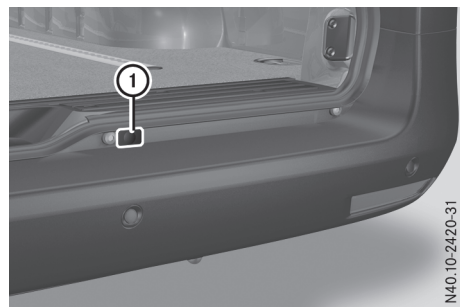

Removing

- ▶ Take the lug wrench and auxiliary tool for the spare wheel lifter out of the vehicle tool kit (▷ page 270).
- ▶ Open the tailgate/rear door.
- ▶ Carefully pry off protective cap ① with a suitable tool, e.g. a screwdriver. Be careful not to damage the paintwork or the covering cap when doing so.

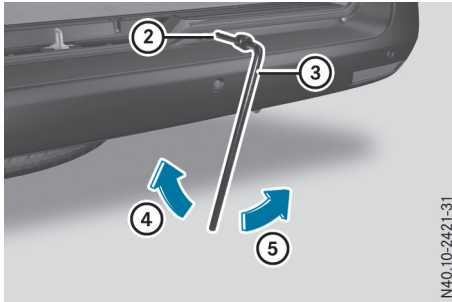

N40.10-2421-31

- ▶ Push auxiliary tool ② through the opening into the winch guide.
- ▶ Attach wheel bolt wrench ③ to auxiliary tool ② for the spare wheel lifter.
- ▶ Turn lug wrench ③ in the direction of arrow ④ until you feel resistance or until the friction clutch of the winch overwinds. The spare wheel has been lowered.

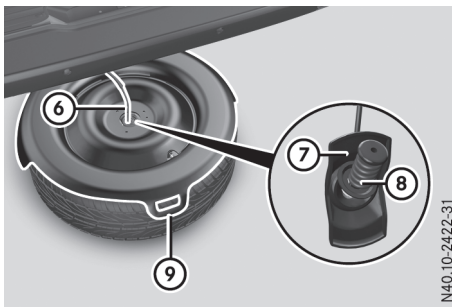

N40.10-2422-31

- ▶ Hold the spare wheel by handle ⑨ on the cover tray and pull it out from under the vehicle.
- ▶ Press cable ⑥ downwards and twist it against spring ⑧ using wheel gripper ⑦. Wheel gripper ⑦ is released.
- ▶ Pull wheel gripper ⑦ through the opening in cover tray ⑨ and out of the wheel brace.
- ▶ Remove cover tray ⑨ from the spare wheel.

- !** When winding upwards, make sure that the handle of the cover tray points backwards. Check that the spare wheel is correctly and firmly positioned:
- after every wheel change
 - at every maintenance interval
 - at least once a year

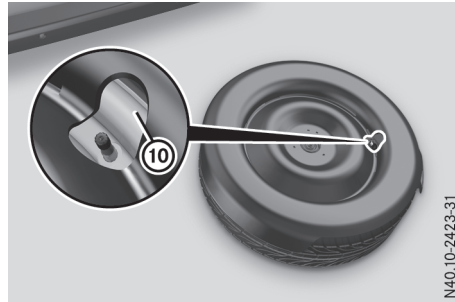

N40.10-2423-31

Installing

- i** Alloy wheels cannot be transported under the vehicle. In this case, transport the alloy wheel in the cargo compartment and only raise cover tray ⑨.
- ▶ Remove lug wrench ③ and auxiliary tool ② for the spare wheel lifter from the vehicle tool kit (> page 270).
- ▶ Place the wheel on the ground with the wheel brace pointing upwards.
- ▶ Place cover tray ⑨ on the wheel so that the recess for tire valve ⑩ is above the valve.
- ▶ Press cover tray ⑨ onto the wheel brace and align the wheel so that the handle of cover tray ⑨ faces backwards.
- ▶ Guide wheel gripper ⑦ at an angle on wire ⑥ through the opening in cover tray ⑨ and into the wheel brace from above.
- ▶ Slide the wheel under the vehicle a little.
- ▶ Attach lug wrench ③ to auxiliary tool ② for the spare wheel lifter.
- ▶ Turn lug wrench ③ in the direction of arrow ⑤ until you feel resistance and the friction clutch of the winch overwinds in jerks. The wheel is firmly secured to the underside of the vehicle.
- ▶ Pull lug wrench ③ and auxiliary tool ② for the spare wheel lifter out of the opening for the winch.
- ▶ Close the winch opening with covering cap ①.
- ▶ Stow wheel bolt wrench ③ and auxiliary tool ② for the spare wheel lifter in the vehicle tool kit.
- ▶ Close the tailgate/rear door.

Useful information

This Operator's Manual describes all models as well as standard and optional equipment of your vehicle that were available at the time of going to print. Country-specific variations are possible. Note that your vehicle may not be equipped with all of the described functions. This also applies to systems and functions relevant to safety.

Read the information on qualified specialist workshops (▷ page 31).

Vehicle electronics

Tampering with the engine electronics

! Only have engine electronics and the corresponding parts, such as control units, actuators, sensors or connector leads, serviced at a qualified specialist workshop. Otherwise, the vehicle parts may wear more quickly. This can lead to loss of the New Vehicle Limited Warranty.

Installing electrical or electronic equipment

You and others can suffer health-related damage through electromagnetic radiation. By using an exterior antenna, a possible health risk caused by electromagnetic fields, as discussed in scientific circles, is taken into account. Only have the exterior antenna installed by a qualified specialist workshop.

Electrical and electronic devices may have a detrimental effect on both the comfort and the operating safety of the vehicle. If equipment of this kind is installed, its electromagnetic compatibility must be checked and verified.

If these devices are linked to functions associated with resistance to interference, they must have type approval. This applies to the device or its interfaces to the vehicle electronics, e.g. charging brackets.

A telephone or two-way radio to be installed in the vehicle must be approved. You can obtain further information from any Mercedes-Benz Commercial Van Center.

For operation of mobile phones and two-way radios, Mercedes-Benz recommends connection to an approved exterior antenna. This is the only way to ensure optimum reception quality inside the vehicle and to minimize mutual interference between the vehicle electronics, mobile phones and two-way radios.

The transmission output of the mobile phone or two-way radio may not exceed the following maximum transmission output (PEAK):

Frequency range	Maximum transmission output (PEAK)
Shortwave (f < 50 MHz)	100 W
4 m waveband	30 W
2 m waveband	50 W
Trunked radio/Tetra	35 W
70 cm waveband	35 W
GSM/UMTS/LTE	10 W

Identification plates

Vehicle identification plate with vehicle identification number (VIN)

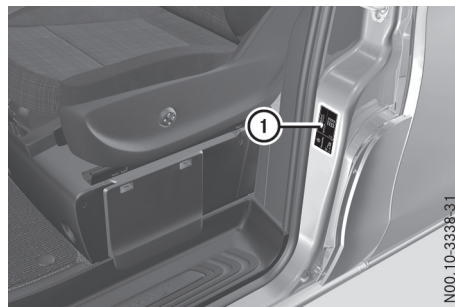

Vehicle identification plate on the driver's side B-pillar

- ▶ Open the driver's door. You will see vehicle identification plate ① with the vehicle identification number (VIN), the paint code and the permissible weight data.

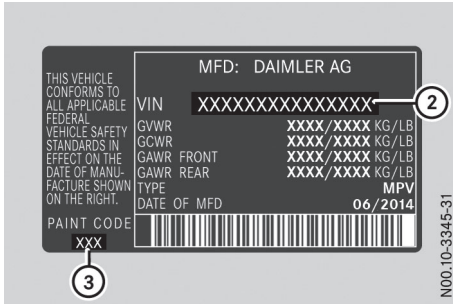

Example: vehicle identification plate (US vehicles)

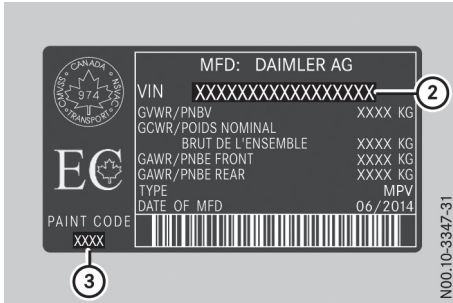

Example: vehicle identification plate (vehicles for Canada)

- ② VIN
- ③ Paint code

i The data shown on the vehicle identification plate is sample data. This data differs for every vehicle and may deviate from what is shown here. The data valid for your vehicle can be found on the identification plate of your vehicle.

Vehicle identification number (VIN)

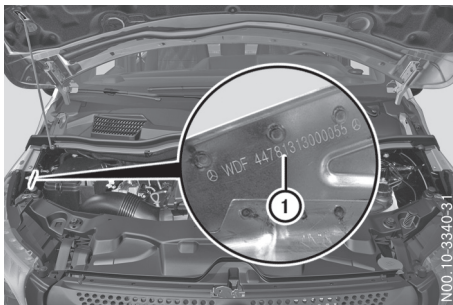

VIN in the engine compartment

The VIN can be found on the vehicle identification plate (▷ page 303).

VIN ① is also stamped into the longitudinal member in the engine compartment next to the fuse box.

Engine number

The engine number is stamped on the crankcase. More information may be obtained at any qualified specialist workshop.

Service products and capacities

Important safety notes

⚠ WARNING

Service products may be poisonous and hazardous to health. There is a risk of injury.

Comply with instructions on the use, storage and disposal of service products on the labels of the respective original containers. Always store service products sealed in their original containers. Always keep service products out of the reach of children.

♻ Environmental note

Dispose of service products in an environmentally responsible manner.

When handling, storing and disposing of any service products, please observe the relevant regulations.

Service products include the following:

- Fuels, e.g. gasoline
- Lubricants, e.g. engine oil, transmission oil
- Coolant
- Brake fluid
- Washer fluid
- Climate control system refrigerants

Approved service products comply with the highest quality standards and are listed in the Mercedes-Benz Specifications for Service Products. Only use service products approved for the vehicle. This is an important condition for the Limited Warranty.

You will recognize the service products approved by Mercedes-Benz by the following

inscription on the containers: MB-Freigabe or MB-Approval (e.g. MB-Freigabe or MB-Approval 228.5).

You can obtain further information at a qualified specialist workshop.

Additives for approved service products are neither required nor permitted. Approved fuel additives are the exception. Additives can cause engine damage and must therefore not be added to the service products.

The use of additives is always the responsibility of the vehicle operator. The use of additives may result in the restriction or loss of your Limited Warranty entitlements.

Fuel

Important safety notes

WARNING

Fuel is highly flammable. Improper handling of fuel creates a risk of fire and explosion.

Avoid fire, open flames, smoking and creating sparks under all circumstances. Switch off the engine and, if applicable, the auxiliary heating before refueling.

WARNING

Fuel is poisonous and hazardous to health. There is a risk of injury.

You must make sure that fuel does not come into contact with your skin, eyes or clothing and that it is not swallowed. Do not inhale fuel vapors. Keep fuel away from children.

If you or others come into contact with fuel, observe the following:

- Wash away fuel from skin immediately using soap and water.
- If fuel comes into contact with your eyes, immediately rinse them thoroughly with clean water. Seek medical assistance without delay.
- If fuel is swallowed, seek medical assistance without delay. Do not induce vomiting.
- Immediately change out of clothing which has come into contact with fuel.

When handling, storing and disposing of fuels, please observe the relevant regulations.

Tank contents

Depending on equipment, the total capacity of the fuel tank may vary.

Total capacity	18.5 US gal (70.0 l)
of which reserve fuel	Approx. 3.2 US gal (12.0 l)

Gasoline

Fuel grade

 Do not use diesel to refuel vehicles with a gasoline engine. Do not switch on the ignition if you accidentally refuel with the wrong fuel. Otherwise, the fuel will enter the fuel system. Even small amounts of the wrong fuel could result in damage to the fuel system and the engine. Notify a qualified specialist workshop and have the fuel tank and fuel lines drained completely.

 Only refuel using unleaded premium grade gasoline with at least 91 AKI/95 RON.

 Only use the fuel recommended. Operating the vehicle with other fuels can lead to damage to the fuel system, engine and exhaust system.

 Do not use the following:

- E15 (gasoline with 15% ethanol)
- E85 (gasoline with 85% ethanol)
- E100 (100% ethanol)
- M15 (gasoline with 15% methanol)
- M30 (gasoline with 30% methanol)
- M85 (gasoline with 85% methanol)
- M100 (100% methanol)
- Gasoline with metalliferous additives
- Diesel

Do not mix such fuels with the fuel recommended for your vehicle.

 Filter the fuel before transferring it to the vehicle if you are refueling the vehicle from barrels or containers.

This will prevent malfunctions in the fuel system due to contaminated fuel.

i E10 fuel contains an admixture of up to 10% bioethanol. Your vehicle is E10 compatible. You can refuel your vehicle with E10 fuel.

i You will generally find information about the fuel grade on the filling pump. If there is no identification on the filling pump, consult a gas station attendant.

As a temporary measure, if the recommended fuel is not available, you may also use regular unleaded gasoline with an octane rating of 87 AKI/91 RON. This may reduce the engine's performance and increase fuel consumption. Avoid driving at full throttle and sudden acceleration. Never refuel using gasoline with a lower AKI/RON rating.

i In some countries, the available gasoline may not be sufficiently low in sulfur. This fuel can temporarily produce unpleasant odors, especially on short journeys. The odors are reduced as soon as sulfur-free fuel (sulfur content < 10 ppm) is used again for refueling.

For more information about refueling (> page 132).

Fuel additives

! Operating the engine with subsequently added fuel additives can cause engine damage. Do not mix fuel additives with fuel. This does not include additives for the removal and prevention of deposits. Gasoline can only be mixed with additives recommended by Mercedes-Benz. Follow the instructions in the product description. You can find further information on recommended additives in any Mercedes-Benz Commercial Van Center.

Mercedes-Benz recommends using brand-name fuels with additives.

If you use fuels without these additives for a long period of time, deposits can form. This primarily forms on the inlet valve and in the combustion chamber.

In some countries, the available fuel grade may be inadequate. Residue could build up in the fuel injection system as a result. In this case, in consultation with a Mercedes-Benz Commercial Van Center, the fuel should be mixed with the cleaning additive recommended by Mercedes-Benz. You must observe the notes and mixing ratios indicated on the container.

Do not add other fuel additives to the fuel. This results in unnecessary costs and can damage the engine.

Information on fuel consumption

🌱 Environmental note

CO₂ (carbon dioxide) is the gas which scientists believe to be principally responsible for global warming (the greenhouse effect). Your vehicle's CO₂ emissions are directly related to fuel consumption and therefore depend on:

- efficient use of the fuel by the engine
- driving style
- other non-technical factors, such as environmental influences, road conditions or traffic flow

You can minimize your vehicle's CO₂ emissions by driving carefully and having it serviced regularly.

Only for certain countries: the respective current consumption and emission values of your vehicle can be found in the COC papers (EC CERTIFICATE OF CONFORMITY). These documents are supplied when the vehicle is delivered.

Consumption figures were found in the currently valid respective version:

- for vehicles up to and including the Euro 4 standard according to EU Directive 80/1268/EEC
- for vehicles from the Euro 5 standard according to regulation (EC) no. 715/2007
- for vehicles from the Euro 6 standard according to regulation (EC) no. 595/2009

Fuel consumption depends on:

- the vehicle version
- the style of driving
- the operating conditions
- the type or quality of the fuel used

The vehicle will use more fuel than usual in the following situations:

- at very low outside temperatures
- in city traffic
- during short journeys
- on mountainous terrain
- when towing a trailer

Observe the advice in the "Protection of the environment" section to keep fuel consumption low (> page 29).

The following components of the different vehicle versions influence fuel consumption:

- tire sizes, tire tread, tire pressure, tire condition
- transmission ratios for the drive assemblies
- additional equipment (e.g. air-conditioning system, auxiliary heating system)

For these reasons, the actual consumption figures for your vehicle may deviate from the consumption figures determined according to EU Directive 80/1268/EEC.

Details on fuel consumption can be called up in the on-board computer:

- on vehicles without steering wheel buttons (▷ page 172)
- on vehicles with steering wheel buttons (▷ page 179)

Engine oil

General notes



When handling engine oil, observe the important safety notes on operating fluids (▷ page 304).

The quality of the engine oil used is of decisive importance for the engine's functionality and operating life. Mercedes-Benz continually approves engine oils based on complex experiments according to the current state of the art.

Therefore, only Mercedes-Benz approved engine oils may be used in Mercedes-Benz engines. Mercedes-Benz recommends having the oil changed at a qualified specialist workshop.

Information about engine oils approved by Mercedes-Benz can be obtained:

- from any Mercedes-Benz Commercial Van Center
- on the Internet at <http://bevo.mercedes-benz.com> by entering the designation, e.g. 229.5.

Mercedes-Benz approval is indicated on the oil container by the inscription „MB-Freigabe“ or „MB Approval“ and the corresponding designation, e.g. MB-Freigabe or MB Approval 229.5.

Designations of the approved engine oils for your vehicle

MB-Freigabe or MB Approval	229.5
-----------------------------------	--------------

Mercedes-Benz recommends that you only use approved multigrade engine oils of the SAE classes SAE 0W-30 and SAE 0W-40 or SAE 5W-30 and SAE 5W-40. These engine oils ensure optimum lubrication even at very low outside temperatures (▷ page 308).

When topping up, we recommend that you only use engine oil of the same grade (MB-Freigabe or MB Approval designation) and SAE class as the oil filled at the last oil change.

i If the engine oils listed in the table are not available, you may add the following engine oils until the next oil change:

- MB-Freigabe or MB Approval 229.1, or ACEA A3

This must only be added once and the amount must not be greater than 1 qt (1.0 l).

Subsequently have the engine oil changed at the earliest possible opportunity.

! Using engine oils of another grade quality is not permitted.

Capacities

! Do not add too much oil. adding too much engine oil can result in damage to the engine or to the catalytic converter. Have excess engine oil siphoned off.

Oil change including oil filter

Engine oil	Approx. 2 US gal (7.75 l)
-------------------	---------------------------

Additives

- ❗ Do not use any additives in the engine oil. This could damage the engine.

Engine oil viscosity

- ❗ If the SAE viscosity class of the engine oil used does not cover the outside temperature range in which you are operating the vehicle, it must be changed in good time, in particular before the cold season commences. Using an engine oil that does not have adequate temperature characteristics can lead to engine damage.

The temperature range information of the SAE classification always refers to that of fresh oil. The temperature characteristics of the engine oil may deteriorate significantly due to aging in use, especially at low outside temperatures.

We recommend that you change the engine oil before the cold season commences. Use an approved engine oil of the specified SAE class.

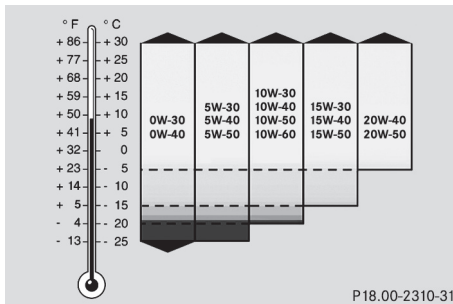

Engine oil SAE classification

Viscosity indicates the flow characteristics of a fluid. If an engine oil has a high viscosity, this means that it is thick; a low viscosity means that it is thin.

Depending on the respective outside temperatures, select an engine oil according to SAE classification (viscosity). The table displays the SAE classification to be used. The low temperature characteristics of engine oils can noticeably deteriorate during operation, e.g. from aging, soot and fuel accretion. For this reason, regular oil changes using an approved engine oil from the suitable SAE classification are urgently recommended.

Oil change

Oil change intervals depend on the vehicle's operating conditions and the quality of the engine oil used. The on-board computer automatically shows the date for the next oil change as an event message in the display.

Mercedes-Benz recommends having the oil changed at a qualified specialist workshop.

Information about oil consumption

Depending on the driving style, the vehicle consumes a maximum of 1.0 US qt (1.0 l) of engine oil over a distance of 620 miles (1,000 km).

Oil consumption may be higher if:

- The vehicle is new.
- You mainly operate the vehicle under arduous operating conditions.
- You frequently drive at high engine speeds.

Regular maintenance is one of the preconditions for moderate rates of consumption.

You can only estimate the oil consumption after you have driven a considerable distance.

Check the engine oil level on a regular basis, e.g. weekly or each time you refuel (> page 252).

Transmission oil

Automatic transmission

Operating fluid: automatic transmission fluid

Product name/number	Maintenance interval
Mobil ATF 134 FE	—
Valvoline ATF Pro 236.15	
MB Sheet No. 236.15	

More information can be obtained at any qualified specialist workshop.

Rear axle

Operating fluid: transmission oil

Product name/number	Maintenance interval
Mobilube FE 75W-85 Mobilube FE Plus NG 75W-85 MB Sheet No. 235.7	—

More information can be obtained at any qualified specialist workshop.

Brake fluid

WARNING

The brake fluid constantly absorbs moisture from the air. This lowers the boiling point of the brake fluid. If the boiling point of the brake fluid is too low, vapor pockets may form in the brake system when the brakes are applied hard. This would impair braking efficiency. There is a risk of an accident.

You should have the brake fluid renewed at the specified intervals.

! Brake fluid corrodes paint, plastic and rubber. If paint, plastic or rubber has come into contact with brake fluid, rinse with water immediately.

When handling, storing and disposing of brake fluid, please observe the relevant regulations and the important safety notes for service products (▷ page 304).

Over a period of time, the brake fluid absorbs moisture from the air. This reduces its boiling point.

Have the brake fluid replaced at specified intervals by a qualified specialist workshop.

i There is usually a notice in the engine compartment to remind you when the next brake fluid change is due.

Use only approved brake fluids that comply with the Mercedes-Benz Specifications for Service Products. Always check for the identification DOT 4 plus.

Information about approved brake fluids can be obtained:

- on the Internet at <http://bevo.mercedes-benz.com>.

Coolant

Important safety notes

WARNING

If antifreeze comes into contact with hot components in the engine compartment, it may ignite. There is a risk of fire and injury.

Let the engine cool down before you add antifreeze. Make sure that antifreeze is not spilled next to the filler neck. Thoroughly clean the antifreeze from components before starting the engine.

! Take care not to spill any coolant on painted surfaces. You could otherwise damage the paintwork.

When handling, storing and disposing of coolant and antifreeze, please observe the relevant regulations and the important safety notes for operating fluids (▷ page 304).

Coolant additive with corrosion and antifreeze protection

! Use only approved antifreeze/corrosion inhibitor that complies with MB Specification for Service Products, Sheet Number 325. Using other, non-approved antifreeze/corrosion inhibitors may cause damage to the coolant system and reduce the engine's service life.

The coolant is a mixture of water and antifreeze and corrosion inhibitor. It performs the following tasks:

- Anti-corrosion protection
- Antifreeze protection
- Raises the boiling point

When the vehicle is first delivered, it is filled with a coolant mixture that ensures adequate antifreeze/corrosion protection. Coolant must remain in the engine cooling system all year round to ensure anti-corrosion protection and a higher boiling point, even in countries with high outside temperatures.

Check the antifreeze/corrosion inhibitor concentration in the coolant every six months.

The percentage of corrosion inhibitor/antifreeze additive in the engine cooling system should:

- be at least 50%. This way, the engine cooling system is protected against freezing down to approximately -35 °F (-37 °C).
- not exceed 55% (antifreeze protection down to -49 °F [-45 °C]). Otherwise, heat will not be dissipated as effectively.

Mercedes-Benz recommends an antifreeze and corrosion inhibitor that meets the requirements in the Mercedes-Benz Specifications for Service Products Sheet Number 325.

More information can be obtained at any qualified specialist workshop.

Operating fluid: coolant

Product name/number

Zerex G40-91, The Valvoline Company
MB Sheet No. 325.5

Maintenance interval

Have the coolant replaced at specified intervals by a qualified specialist workshop.

Capacities

Engine cooling system

Coolant	Approx. 11 US qt (10.4 l)
---------	------------------------------

Climate control system refrigerants

Important safety notes

The climate control system of your vehicle is filled with the refrigerant R-134a.

The warning label for the refrigerant being used can be found on the radiator cross member.

! Only the refrigerant R-134a and the PAG oil approved by Mercedes-Benz may be used. The approved PAG oil may not be mixed with any other PAG oil that is not approved for R-134a refrigerant. Otherwise, the climate control system may be damaged.

Maintenance work such as adding refrigerant or replacing components may only be carried out by a qualified specialist workshop. All applicable regulations thereto and the SAE standard J639 must be adhered to.

All work on the climate control system should always be carried out at qualified specialist workshop.

Refrigerant warning label

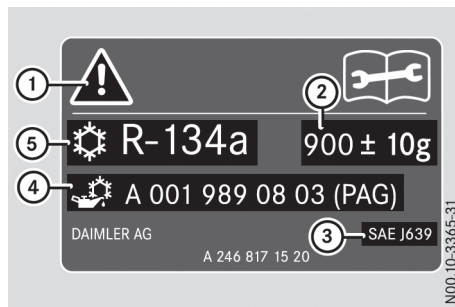

Refrigerant warning label (example)

- ① Warning symbols
- ② Refrigerant capacity
- ③ Applicable standards
- ④ Part number PAG oil
- ⑤ Type of refrigerant

Warning symbols ① refer to:

- possible dangers
- the implementation of maintenance work at a qualified specialist workshop

Capacities

Front-compartment air-conditioning system	Capacity
Refrigerant	21.2 oz (600 g)
PAG oil	2.8 oz (79 g)

Rear-compartment air-conditioning system	Capacity
Refrigerant	31.7 oz (950 g)
PAG oil	4.9 oz (139 g)

Washer fluid

Important safety notes

⚠ WARNING

Windshield washer concentrate could ignite if it comes into contact with hot engine components or the exhaust system. There is a risk of fire and injury.

Make sure that no windshield washer concentrate is spilled next to the filler neck.

! Only use washer fluid that is suitable for plastic lamp lenses, e.g. MB SummerFit or MB WinterFit. Unsuitable washer fluid could damage the plastic lenses of the headlamps.

When handling washer fluid, observe the important safety notes on service products (▷ page 304).

Mixing ratio

Add windshield washer concentrate to the washer fluid all year round. Adapt the mixing ratio to the ambient temperature.

At temperatures above freezing:

- ▶ Fill up the washer fluid reservoir with a mixture of water and windshield washer concentrate, e.g. Summerwash to prevent smearing.

At temperatures below freezing:

- ▶ Fill up the washer fluid reservoir with a mixture of water and windshield washer concentrate, e.g. Winterwash if there is a danger of frost. This prevents washer fluid from freezing on the windshield.

Capacities

Windshield washer system with/without heating

Washer fluid reservoir	Washer fluid
Unheated	Approx. 3.7 US qt (3.5 l)
Heated	Approx. 6.3 US qt (6.0 l)

Vehicle data

General notes

The following section contains important technical data for your vehicle. Additional vehicle-specific and equipment-dependent technical data, such as vehicle weights, can be found in your vehicle registration papers.

Dimensions

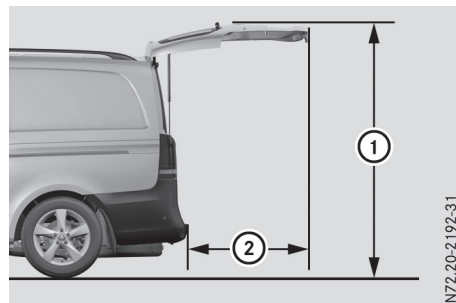

Vehicle with tailgate

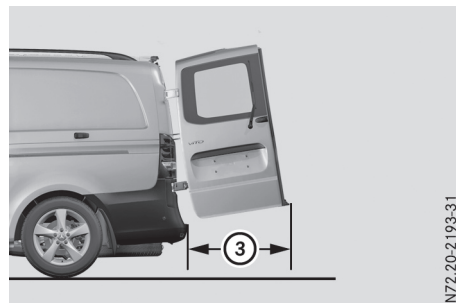

Vehicle with rear doors

N72.20-2192-31

N72.20-2193-31

The dimensions specified vary according to:

- Tires
- Load
- Condition of the suspension
- Optional equipment

Model	Cargo Van
Opening height of the tailgate ①	86.0 in (2185 mm)
Opening range of the tailgate ②	41.2 in (1047 mm)
Opening range of the rear doors ③	33.4 in (849 mm)
Load width	50.0 in (1270 mm)
Max. load width	66.3 in (1685 mm)
Load height	53.8 in (1367 mm)
Vehicle length	202.4 in (5140 mm)
Vehicle width	
Including exterior mirrors	88.3 in (2244 mm)
Excluding exterior mirrors	75.9 in (1928 mm)
Wheelbase	126.0 in (3200 mm)

Technical data

Model	Passenger Vans
Opening height of the tailgate ①	84.6 in (2150 mm)
Opening range of the tailgate ②	41.2 in (1047 mm)
Opening range of the rear doors ③	33.4 in (849 mm)
Load width	47.4 in (1205 mm)
Max. load width	61.1 in (1552 mm)
Load height	52.2 in (1326 mm)
Vehicle length	202.4 in (5140 mm)

Model	Passenger Vans
Vehicle width	
Including exterior mirrors	88.3 in (2244 mm)
Excluding exterior mirrors	75.9 in (1928 mm)
Wheelbase	126.0 in (3200 mm)

Cargo tie-down points and carrier systems

Cargo tie-down points

General notes

! Observe the information on the maximum loading capacity of the individual cargo tie-down points.

If you use several cargo tie-down points to secure a load, you must always take the maximum loading capacity of the weakest cargo tie-down point into account.

If you brake hard, for example, the forces acting could be up to several times the weight force of the load. Always use multiple cargo tie-down points in order to distribute the force absorption. Load the anchorages evenly.

You will find additional information about cargo tie-down points and cargo tie-down rings in the "Securing loads" section (> page 244).

Cargo tie-down rings

The maximum tensile load of the cargo tie-down rings is:

Cargo tie-down rings	Permissible nominal tensile load
Passenger Vans	786.5 lbf (350 daN)
Cargo Van	1124.0 lbf (500 daN)

Guide/load rails

The maximum tensile load for the cargo tie-down points on a guide/load rail is:

Cargo tie-down point	Permissible nominal tensile load
Guide rail	786.5 lbf (350 daN)
Load rails on cargo compartment floor	1 124.0 lbf (500 daN)
Load rail on sidewall	225.0 lbf (100 daN)

The values specified apply only to loads placed on the cargo compartment floor if:

- the load is secured to two cargo tie-down points on the rail and
- the distance to the nearest load-securing point on the same rail is approximately 3 ft (1 m)

Maximum roof load

WARNING

If you use openings in the bodywork or detachable parts as steps, you could:

- slip and/or fall
- damage the vehicle and cause yourself to fall.

There is a risk of injury.

Always use secure climbing aids, e.g. a suitable ladder.

- !** Do not use the lower sliding door guide (carriage) as a step. Otherwise, you could damage the paneling and/or the sliding door mechanism.

WARNING

When you load the roof, the center of gravity of the vehicle rises and the driving characteristics change. If you exceed the maximum roof load, the driving characteristics, as well as steering and braking, will be greatly impaired. There is a risk of an accident.

Never exceed the maximum roof load and adjust your driving style.

- !** The weight of any load carried on the roof, including the roof carrier, must not exceed the maximum permissible roof load.

The roof carrier supports must be mounted at equal distances.

Install rail carriers in front of and behind the middle prop.

- !** For safety reasons, Mercedes-Benz recommends that you only use roof carrier systems which have been tested and approved for Mercedes-Benz vehicles. This will help to avoid damage.

Maximum roof load	330 lbs (150 kg) with at least three pairs of support points
--------------------------	---

The data is valid for a load distributed evenly over the entire roof area.

Reduce the load on shorter roof carriers proportionately. The maximum load per pair of roof carrier supports is 110 lbs (50 kg). The maximum load of a rail carrier bar is 220 lbs (100 kg).

Loading guidelines and other information concerning load distribution and load securing can be found in the "Transporting" section (> page 242).

Trailer tow hitch

General notes

Mercedes-Benz recommends having a trailer tow hitch retrofitted at an authorized Mercedes-Benz Van Dealer.

Use only a trailer tow hitch that has been tested and approved specially for your vehicle by the distributor named on the inside of the front cover. Only use a ball coupling for your Metris trailer tow hitch if it has been approved for your vehicle. You can also find information on the permitted dimensions of the ball coupling on the identification plate of the trailer tow hitch.

You can obtain advice from a qualified specialist workshop. Also observe the information on towing a trailer in the "Driving and parking" section (> page 163).

Trailer loads

Make sure that you adhere to the local legal requirements for trailer loads.

The permissible weights and loads which cannot be exceeded can also be found:

- in your vehicle documents and
- on the identification plates of the trailer tow hitch, the trailer and the vehicle
(▷ page 303)

You will find the basic values approved by the manufacturer in the following table. If the values differ, the lowest value applies.

Make sure that you adhere to the weight restrictions by having the weight checked on a calibrated weighbridge.

Permissible gross weight GVWR	6724 lbs (3050 kg)
Gross front axle load GAWR (FA)	3417 lbs (1550 kg)
Gross rear axle load GAWR (RA)	3417 lbs (1550 kg)
Maximum permissible gross weight of vehicle/trailer combination² GCWR	11684 lbs (5300 kg)
Trailer load, braked³ GTW	5000 lbs (2268 kg)
Maximum permissible nose weight TWR	500 lbs (227 kg)

² Maximum permissible gross weight of the vehicle and trailer.

³ Maximum permissible gross trailer weight, for trailers with a separate functional braking system.

