



Metris

Operating Instructions



4475842207

Order no. T447 0250 13 Part no. 447 584 22 07 Edition 2020-10

Metris Operating Instructions

Mercedes-Benz



Co-driver's airbag warning

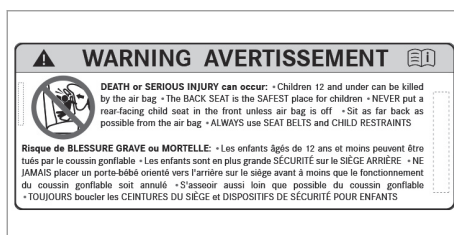
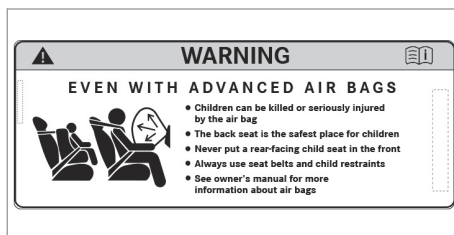

Airbag warning sticker for USA and Canada

⚠ WARNING Risk of injury or death if the co-driver airbag is enabled

If the co-driver airbag is enabled, a child on the co-driver seat may be struck by the co-driver airbag during an accident.

NEVER use a rearward-facing child restraint system on a seat with an ENABLED FRONT AIRBAG; DEATH or SERIOUS INJURY to the CHILD can occur.

Observe the chapter "Children in the vehicle".

Publication details

Internet

Further information about Mercedes-Benz vehicles and about Mercedes-Benz AG can be found on the following websites:

<https://www.mercedes-benz.com>

<https://www.mbusa.com> (USA only)

<https://www.mercedes-benz.ca> (Canada only)

Documentation team

©Daimler VANS USA, LLC

©Mercedes-Benz AG: Not to be reprinted, translated or otherwise reproduced, in whole or in part, without written permission from Mercedes-Benz AG.

Vehicle manufacturer

Mercedes-Benz AG

Mercedesstraße 120

70372 Stuttgart

Germany

Vehicle dealers

Daimler VANS USA, LLC

One Mercedes-Benz Drive

Sandy Springs, GA 30328

<https://www.mbusa.com> (USA only)

<https://www.mbvans.com>

Customer Assistance Center:

1-877-762-8267

Mercedes-Benz Canada, Inc.

98 Vanderhoof Avenue

Toronto, ON M4G 4C9

<https://www.mercedes-benz.ca> (Canada only)

Customer Relations Department:

1-800-387-0100

Daimler VANS USA, LLC and Mercedes-Benz Canada, Inc. are Daimler AG enterprises.

Welcome to the world of Mercedes-Benz

Before you first drive off, read these Operating Instructions carefully and familiarize yourself with your vehicle. For your own safety and a longer vehicle life, follow the instructions and warning notices in these Operating Instructions. Disregarding them may result in damage to the vehicle or environment or in personal injury.

Vehicle damage caused by failure to observe the instructions is not covered by the Mercedes-Benz limited warranty.

The standard equipment and product description of your vehicle may vary and depends on the following factors:

- Model
- Order
- National version
- Availability

Mercedes-Benz reserves the right to introduce changes in:

- Design
- Equipment
- Technical features

Therefore, the description may differ from your vehicle in some cases.

The following documents are integral parts of the vehicle:

- Printed Operating Instructions
- Maintenance Booklet
- Equipment-dependent supplements

Always keep these documents in the vehicle. If you sell the vehicle, always pass all documents on to the new owner.

Mercedes-Benz USA, LLC

Mercedes-Benz Canada, Inc.

A Daimler Company

4475842207



Symbols	4	Electric sliding door	47
		Tailgate	51
		Rear-end doors	54
		Side window	56
		Anti-theft prevention	59
At a glance	6	Seats and stowage	62
Cockpit	6	Correct driver's seat position	62
Indicator and warning lamps (vehicles without steering wheel buttons)	7	Seats	62
Indicator and warning lamps (vehicles with steering wheel buttons)	8	Stowage areas	75
Steering wheel with buttons	9	Information about the bottle holder	75
Center console	10	Cup holders	75
Overhead control panel	11	Ashtray and cigarette lighter	76
Door control panel	12	Sockets	76
General notes	13	Light and vision	77
Environmental protection	13	Exterior lighting	77
Mercedes-Benz GenuineParts	13	Adjusting the interior lighting	80
Notes about attachments, add-on equipment, installations and conver- sions	14	Changing bulbs	80
Operating Instructions	14	Windshield wipers	85
Service and vehicle operation	15	Mirrors	88
Operating safety	16	Operating sun visors	89
Diagnostics connection	17	Climate control	90
Notes on changes to the engine output	17	Overview of climate control systems	90
Qualified specialist workshop	18	Operating climate control systems	91
Vehicle registration	18	Operating air vents	95
Correct use of the vehicle	18	Driving and parking	97
Multi Purpose Vehicle	19	Driving	97
Notes for persons with electronic med- ical aids	19	Automatic transmission	104
Information on problems with your vehicle	19	Refueling	106
Reporting safety defects	19	Parking	108
Limited Warranty	20	Driving and driving safety systems	109
QR codes for rescue card	20	Trailer operation	131
Data storage	20	Instrument cluster and on-board computer	136
Copyright	23	Notes on the instrument cluster and on-board computer	136
Occupant safety	24	Overview of the instrument cluster	136
Restraint system	24	Overview and operation of the on- board computer (vehicles without steering-wheel buttons)	137
Seat belts	25	Overview and operation of the on- board computer (vehicles with steer- ing-wheel buttons)	138
Airbags	28	Overview of what is shown on the mul- tifunction display	140
Automatic measures after an accident	33	Setting the instrument lighting	141
Safely transporting children in the vehicle	33		
Notes on pets in the vehicle	41		
Opening and closing	42		
SmartKey	42		
Doors	45		
Sliding door	47		

Overview of menus on the on-board computer	141	Vehicle tool kit	201
Menus and submenus (vehicles without steering wheel buttons)	142		
Menus and submenus (vehicles with steering-wheel buttons)	144		
<hr/>		<hr/>	
Mercedes PRO	150	Wheels and tires	204
Information about Mercedes PRO (Mercedes me)	150	Information on noise or unusual driving characteristics	204
Information about Mercedes PRO connect (Mercedes me connect)	150	Notes on regularly inspecting wheels and tires	204
Making a call via the overhead control panel	150	Information on driving with summer tires	204
Information on the breakdown assistance call via the overhead control panel	151	Information on M+S tires	205
Giving permission for data transfer	151	Notes on snow chains	205
Transmitted data during a service call	151	Tire pressure	206
		Tire labeling	211
		Information on definitions (tires and loading)	214
		Changing a wheel	216
		Information on wheel and tire combinations	221
		Spare wheel	222
<hr/>		<hr/>	
Multimedia system	152	Technical data	225
Notes on operating safety	152	Notes on the technical data	225
Overview and operation	152	On-board electronics	225
System settings	153	Vehicle identification plate, vehicle identification number (VIN) and engine number	226
Calling up the tool menu	155	Operating fluids and capacities	227
Navigation	155	Vehicle data	232
Setting functions for smartphones	161	Trailer hitch	233
Media	162	Cargo tie-down points and carrier systems	234
Radio	163		
Updating maps and system software	165		
<hr/>		<hr/>	
Transporting	166	Display messages and warning and indicator lamps	235
Notes on loading guidelines	166	Display messages	235
Load distribution	167	Indicator and warning lamps	260
Securing loads	168		
Load securing aid	172		
Carrier systems	173		
<hr/>		<hr/>	
Maintenance and care	175	Index	270
Notes on maintenance	175		
Service interval display	175		
Engine compartment	176		
Cleaning and care	182		
<hr/>		<hr/>	
Breakdown assistance	187		
Emergency	187		
Mercedes-Benz emergency call system ...	187		
Flat tire	189		
Battery	189		
Towing or tow-starting	197		
Electrical fuses	201		

4 Symbols

In these Operating Instructions, you will find the following symbols:

 **DANGER** Danger due to not observing the warning notices

Warning notices draw your attention to hazards that may endanger your health or life, or the health or life of others.

► Observe the warning notices.

 **ENVIRONMENTAL NOTE** Environmental damage due to failure to observe environmental notes

Environmental notes include information on environmentally responsible behavior or environmentally responsible disposal.

► Observe environmental notes.

 **NOTE** Damage to property due to failure to observe notes on material damage

Notes on material damage inform you of risks which may lead to your vehicle being damaged.

► Observe notes on material damage.

 These symbols indicate useful instructions or further information that could be helpful to you.

► Instructions

(→ Further information on a topic page)

Display Display in the multifunction display/media display



 Highest menu level to be selected in the multimedia system

 Corresponding submenus to be selected in the multimedia system

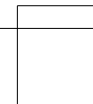
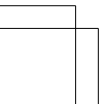
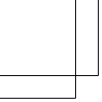
* Indicates a cause

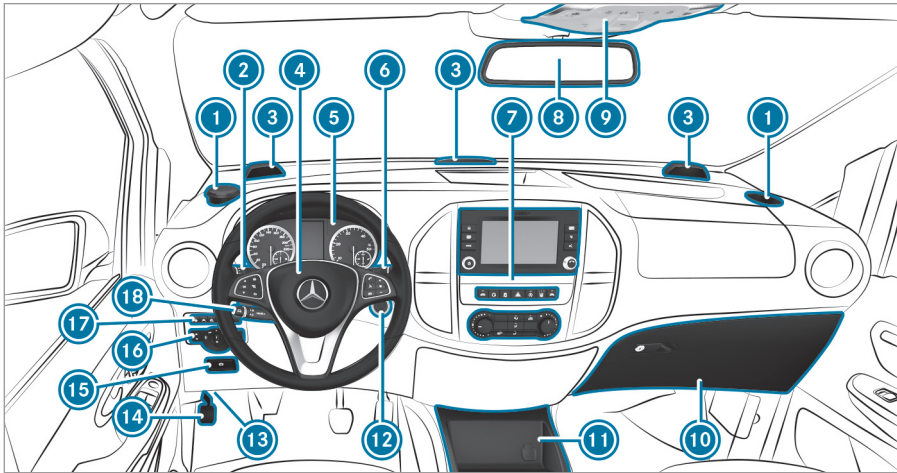



① Cup holders	→	75	⑪ Storage compartment		
Ashtray	→	76	12 V socket	→	76
② Combination switch	→	78	Cigarette lighter	→	76
③ PARKTRONIC warning displays	→	122	⑫ Ignition lock	→	97
④ Adjusts the steering wheel			⑬ Diagnostics connection	→	17
Steering wheel gearshift paddles	→	106	Opening the hood	→	176
Horn			⑭ Applies the parking brake	→	109
⑤ Instrument cluster	→	136	⑮ Releases the parking brake	→	109
⑥ DIRECT SELECT lever	→	104	⑯ Light switch	→	77
⑦ Center console operating unit			⑰ Switch panel for driving systems:		
⑧ Inside rearview mirror			 Lane Keeping Assist	→	129
⑨ Overhead control panel			 Switches PARKTRONIC on/off	→	122
Interior lamp	→	80	⑱ Cruise control lever	→	115
⑩ Glove box	→	75			

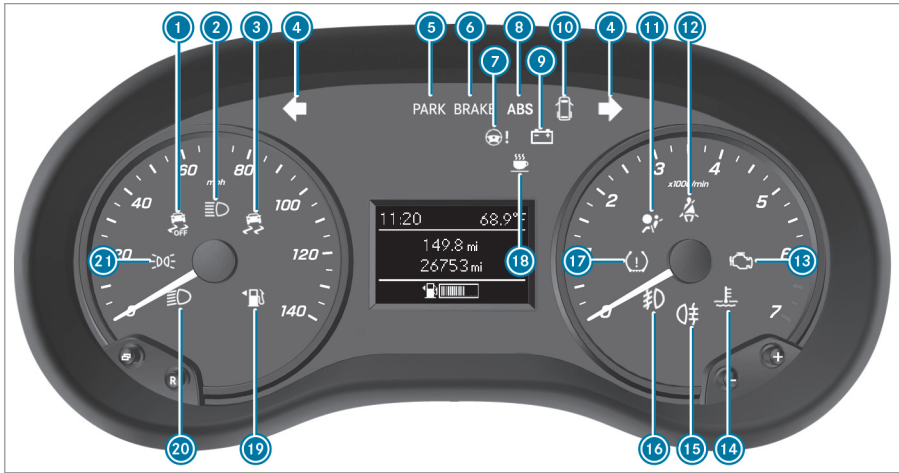

1	ESP® OFF	→	261	12	Seat belt	→	264
2	High beam	→	78	13	Check Engine	→	265
3	ESP®	→	261	14	Coolant	→	265
4	Turn signal lights	→	78	15	Rear fog light	→	77
5	PARK Parking brake (USA only)	→	109	16	Fog lights	→	77
	Parking brake (Canada only)	→	109	17	Tire pressure monitoring system	→	268
6	BRAKE Brakes (USA only)	→	261	18	ATTENTION ASSIST	→	127
	Brakes (Canada only)	→	261	19	Reserve fuel	→	265
7	Power steering	→	265	20	Low beam	→	77
8	ABS	→	261	21	Parking lamps and license plate lamp	→	77
9	Power supply	→	251		Corresponding messages may also be shown on the multi-function display.	→	235
10	Doors	→	265				
11	Restraint system	→	261				

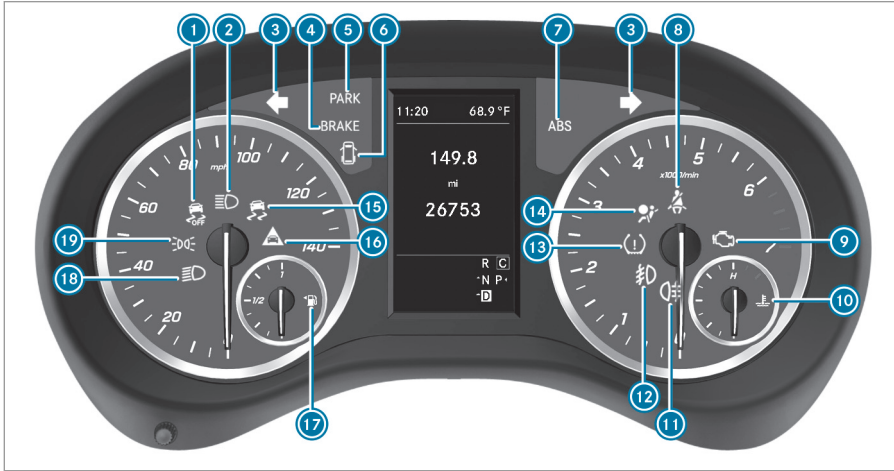

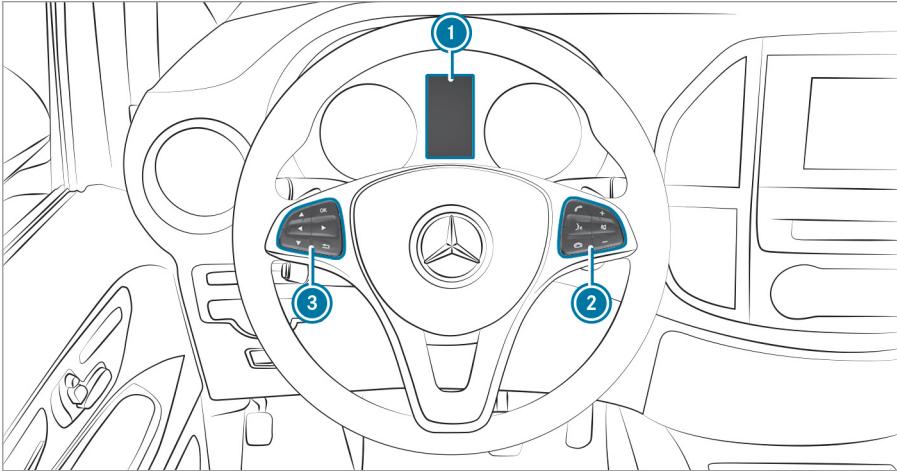

1	ESP® OFF	→	261	11	Rear fog light	→	77
2	High beam	→	78	12	Fog lights	→	77
3	Turn signal lights	→	78	13	Tire pressure monitoring system	→	268
4	Brakes (USA only)	→	261	14	Restraint system	→	261
	Brakes (Canada only)	→	261	15	ESP®	→	261
5	Parking brake (USA only)	→	109	16	Distance warning	→	265
	Parking brake (Canada only)	→	109	17	Reserve fuel	→	265
6	Doors	→	265	18	Low beam	→	77
7	ABS	→	261	19	Parking lamps and license plate lamp	→	77
8	Seat belt	→	264		Corresponding messages may also be shown on the multi-function display.	→	235
9	Check Engine	→	265				
10	Coolant	→	265				



① Multifunction display → 140

②  Ends or declines calls/ exits the phone book or redial memory → 147

 Makes or accepts calls/ switches to the redial memory

 Adjusts the volume

 Mutes

 Vehicles with a navigation system: switches on voice control of the navigation system (see the manufacturer's operating instructions)

③  Calls up the menu bar in the multifunction display and selects menus → 138

 Selects a submenu or function/scrolls through lists

 Confirms a selection/ hides display messages

 Back/vehicles with a navigation system: switches off voice control of the navigation system (see the manufacturer's operating instructions)

The multimedia system, telephone, and voice control via the steering wheel buttons in the right control panel only function with a Mercedes-Benz audio or navigation system. If you are using an audio or navigation system from another manufacturer, the described functions may be restricted or may not be available at all.

Operating unit

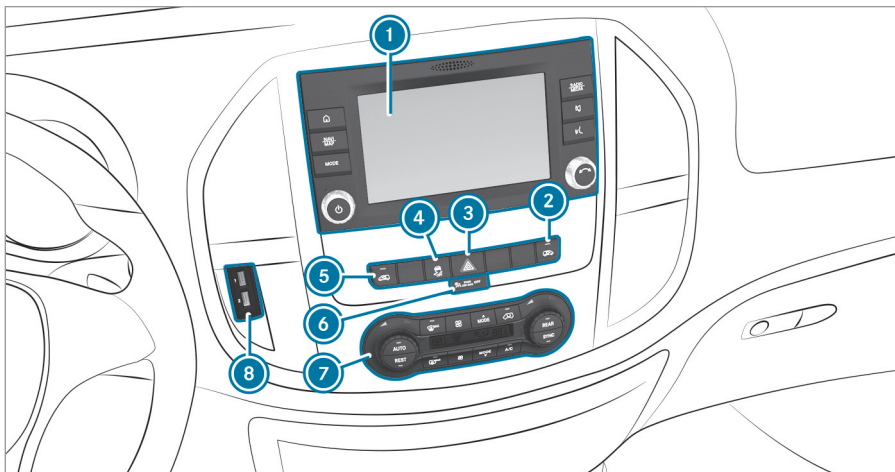



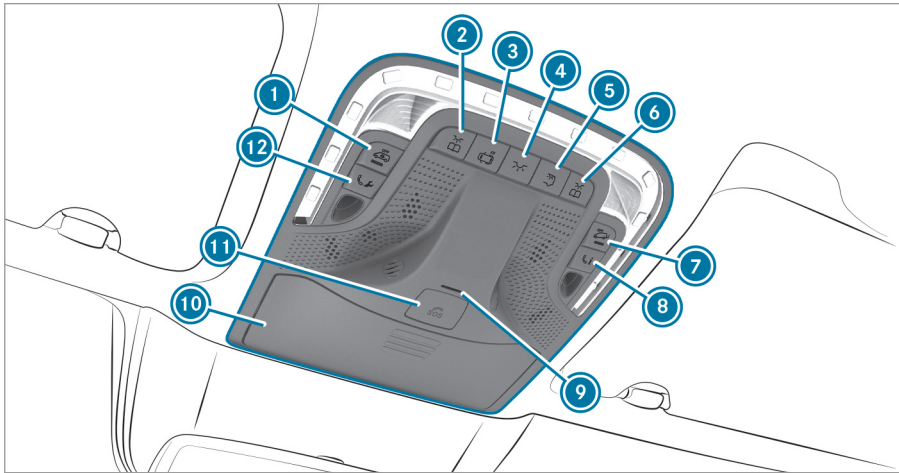

1 Multimedia system	→	152	6 PASSENGER AIR BAG OFF indicator lamp	→	31
2 Opens and closes the electric sliding door on the right side of the vehicle	→	47	7 Climate control system operating unit	→	90
3 Switches the hazard warning light system on and off	→	78	8 Media interface with AUX connection and USB port		
4 Switches ESP® on and off	→	111	The layout and number of buttons depend on the equipment.		
5 Opens and closes the electric sliding door on the left side of the vehicle	→	47			

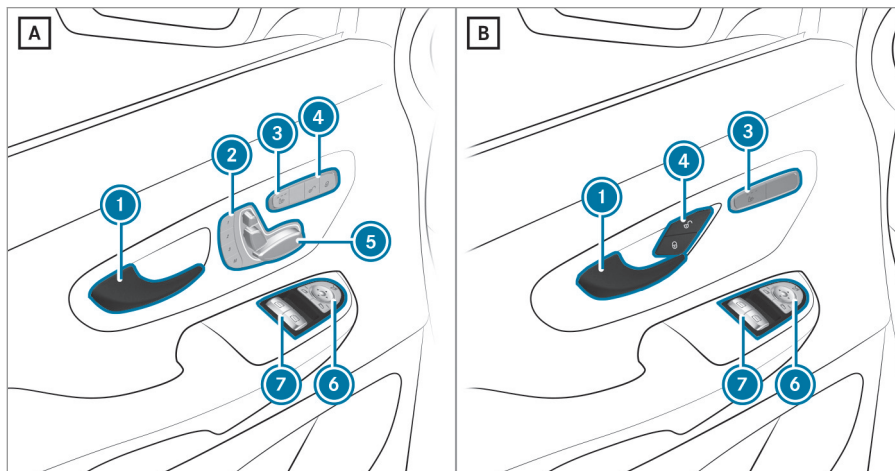

①	Deactivates the interior motion sensor	→	60	⑥	Switches the right-hand reading lamp on/off	→	80
②	Switches the left-hand reading lamp on/off	→	80	⑦	Deactivates the tow-away alarm	→	60
③	Switches automatic interior lighting control on/off	→	80	⑧	Button for Info call	→	150
④	Switches the front interior lighting on/off	→	80	⑨	ATA indicator lamp	→	59
⑤	Switches the rear passenger compartment/cargo compartment lamp on/off	→	80	⑩	Glasses compartment	→	75
				⑪	SOS button	→	187
				⑫	Breakdown assistance call button	→	150



<p>A Vehicles with electrically adjustable front seats</p> <hr/> <p>B Vehicles with manually adjustable front seats</p>	<p>④   Unlocks/locks the vehicle → 45</p> <hr/> <p>⑤ Adjusts the seat electrically → 64</p> <hr/> <p>⑥ Adjusts and folds the outside mirrors in/out electrically → 88</p> <hr/> <p>⑦  Opens/closes the front side windows → 56</p>
<p>① Opens a door → 45</p> <hr/> <p>② Stores seat settings → 65</p> <p>M ① ② ③</p> <hr/> <p>③  Seat heating → 74</p>	

Environmental protection

 **ENVIRONMENTAL NOTE** Environmental damage due to operating conditions and personal driving style

The pollutant emission of the vehicle is directly related to the vehicle's operation. Operate the vehicle in an environmentally responsible manner to make a contribution to environmental protection. To do this, observe the following recommendations on operating conditions and your personal driving style.

Operating conditions:

- ▶ Make sure that the tire pressures are always correct.
- ▶ Do not carry any unnecessary weight in the vehicle.
- ▶ Observe the service intervals. A regularly serviced vehicle will contribute to environmental protection.
- ▶ Always have maintenance work carried out at a qualified specialist workshop.

Personal driving style:

- ▶ Do not depress the accelerator pedal when starting the engine.
- ▶ Do not warm up the engine while stationary.
- ▶ Drive carefully and maintain a sufficient distance to other vehicles.
- ▶ Avoid frequent, sudden acceleration and braking.
- ▶ Shift gears in good time and use each gear only up to $\frac{2}{3}$ of its maximum engine speed.
- ▶ Switch off the engine when in stationary traffic for a prolonged time.
- ▶ Drive in a fuel-efficient manner.

Environmental issues and recommendations

It is recommended that you re-use or recycle materials instead of just disposing of them.

The relevant environmental guidelines and regulations serve to protect the environment and should be followed carefully.

Mercedes-Benz GenuineParts

 **ENVIRONMENTAL NOTE** Environmental damage due to not using recycled reconditioned components

Mercedes-Benz AG offers recycled reconditioned components and parts with the same quality as new parts. The same entitlement from the Limited Warranty is valid as for new parts.

- ▶ Use recycled reconditioned components and parts from Mercedes-Benz AG.

 **NOTE** Impairment of the operating efficiency of the restraint systems from installing accessory parts or from repairs or welding

Airbags and Emergency Tensioning Devices, as well as control units and sensors for the restraint systems, may be installed in the following areas of your vehicle:

- Doors
- Door pillars
- Door sills
- Seats
- Cockpit
- Instrument cluster
- Center console

- ▶ Do not install accessories such as audio systems in these areas.
- ▶ Do not carry out repairs or welding.
- ▶ Have accessory parts retrofitted at a qualified specialist workshop.

If you use parts, tires, wheels or safety-relevant accessories which have not been approved by Mercedes-Benz, the operating safety of the vehicle may be jeopardized. Safety-relevant systems, e.g. the brake system, may malfunction. Use only genuine Mercedes-Benz parts or parts of equal quality. Use only tires, wheels and accessory parts that are approved for your vehicle model.

Notes about attachments, add-on equipment, installations and conversions

Notes on body/equipment mounting directives

Both vehicle manufacturers and body manufacturers must always ensure that the products they manufacture come into circulation only in a safe state and do not pose any risks to people. Otherwise, there may be consequences under civil, criminal or public law. All manufacturers are responsible for the products that they have manufactured. Manufacturers of attachments, add-on equipment, installations and conversions must guarantee compliance with Directive 2001/95/EC on general product safety.

Mercedes-Benz recommends the following procedure for safety reasons:

- Do not make any other changes to the vehicle.

Acceptance tests performed by public test bodies or official approvals do not rule out safety risks.

- ① You can obtain further information at a qualified specialist workshop.

⚠ WARNING Risk of accident and injury in the event of improper conversions or changes to the vehicle

Conversions or changes to the vehicle can prevent systems or components from functioning properly and/or jeopardize the vehicle's operational safety.

- ▶ Always have conversions or changes to the vehicle carried out at a qualified workshop.

If you intend to make changes to your vehicle, Mercedes-Benz strongly recommends that you contact the dealer. They will give you all the information you need. There may be a charge for this service.

If body manufacturers and dealers make modifications that affect the final inspection of the engine, vehicle or equipment, they must accept sole responsibility for the vehicle. This also applies to marking and documenting the vehicle parts affected by the changes that they make.

You are responsible for ensuring and providing evidence that the following conditions are met:

- The vehicle complies with all relevant standards and regulations that are affected by the modification.
- The modified vehicle still meets the vehicle safety standards and emissions laws and regulations.
- The modification does not impair the safety of the vehicle.

Mercedes-Benz is not responsible for the final inspection, product liability or warranty claims resulting from modification. This applies to the following points:

- The modified components or systems
- The resultant violation of emissions laws and regulations or vehicle safety standards
- All consequences resulting from the modified, less safe or even faulty vehicle

Mercedes-Benz accepts no responsibility as final manufacturer or for the resultant product liability.

Notes on the radiator

Even seemingly minor changes to the vehicle, such as attaching a radiator grill in winter, are not permitted. Do not cover the radiator. Do not use any thermal mats, insect protection covers etc.

Otherwise, the values of the vehicle's diagnostic system will be distorted. Some of these values are prescribed by law and must be correct at all times.

Notes on the partition

Without a partition, vehicles that are registered as commercial vehicles (N1) do not fulfill ISO 27956, which describes the equipment for properly securing a load in delivery vehicles. If the vehicle is used to transport goods, retrofitting the partition is strongly recommended, as properly securing the load in vehicles without a partition will always be a complex operation.

Operating Instructions

These Operating Instructions describe all models, as well as standard and optional equipment of your vehicle that was available at the time of going to press. Country-specific differences are possible. Note that your vehicle may not be equipped with all functions described. This is also the case for systems and functions relevant to safety. Therefore, the equipment on your vehicle

may differ from that in the descriptions and illustrations.

The original purchase agreement documentation for your vehicle contains a list of all the systems in your vehicle.

Should you have any questions concerning equipment and operation, consult an authorized Mercedes-Benz Center.

The Operating Instructions and Maintenance Booklet are important documents and should be kept in the vehicle.

Note on vehicles which are equipped by body manufacturers

Always observe the body manufacturer's Operating Instructions. You could otherwise fail to recognize dangers.

Service and vehicle operation

Warranty

The Limited Warranty for your vehicle is in accordance with the warranty terms and conditions in the Service and Warranty Information booklet.

Your authorized Mercedes-Benz Center will replace and repair all factory-installed parts in accordance with the terms of the following warranty terms and conditions:

- New Vehicle Limited Warranty
- Exhaust System Warranty
- Emission Systems Warranty
- California, Connecticut, Maine, Massachusetts, New York, Pennsylvania, Rhode Island and Vermont Emission Control System Warranty
- State Warranty Enforcement Laws ("Lemon Laws")

Replacement parts and accessories are covered by the Mercedes-Benz Parts and Accessories Warranties.

These are available at any authorized Mercedes-Benz Center.

- ① Should you lose your Service and Warranty Information booklet, have an authorized Mercedes-Benz Center arrange for a replacement. The new Service and Warranty Information booklet will be posted to you.

Vehicle operation outside the USA or Canada

When you are traveling abroad with your vehicle, observe the following points:

- service points or replacement parts may not be available immediately.
- unleaded fuel for vehicles with a catalytic converter may not be available. Leaded fuel can cause damage to the catalytic converter.
- the fuel may have a considerably lower octane number. Unsuitable fuel can cause engine damage.

Certain Mercedes-Benz models are available in Europe through the European Delivery Program.

For more information, please consult an authorized Mercedes-Benz Center, or write to one of the following addresses:

In the USA:

Daimler VANS USA, LLC
European Delivery Department
One Mercedes-Benz Drive
Sandy Springs, GA 30328

In Canada:

Mercedes-Benz Canada, Inc.
European Delivery Department
98 Vanderhoof Avenue
Toronto, Ontario M4G 4C9

Maintenance information

Your customer service advisor will record every service for you in the Service and Warranty Information booklet.

Information on Roadside Assistance

Roadside Assistance offers technical help in the event of a breakdown. Your calls to the toll-free Roadside Assistance Hotline are answered by our agents 24 hours a day, 365 days a year.

1-877-762-8267 (USA)

1-800-387-0100 (Canada)

You can find further information in the Roadside Assistance brochure (USA) or the "Roadside Assistance" section in the Service and Warranty booklet (Canada). You will find both in the vehicle document wallet.

Information on changing address or owner

In the event of a change of address, please send us the "Notification of Address Change" in the Service and Warranty Information booklet or simply call the Customer Assistance Center (USA) at the hotline number 1-877-762-8267 or Customer Service (Canada) at 1-800-387-0100. This way, if necessary, we can reach you in a timely fashion.

If you sell your Mercedes, please leave the entire literature in the vehicle so that it is available to the next owner. If you have purchased a used vehicle, please send us the "Notice of Purchase of Used Car" in the Service and Warranty Information booklet or call the Customer Assistance Center (USA) at the hotline number 1-877-762-8267 or Customer Service (Canada) at 1-800-387-0100.

Possible danger due to substances hazardous to health

In compliance with Proposition 65 ("Prop65"), the following detachable label has been added to each vehicle sold in California:



Operating safety

⚠ WARNING Risk of accident due to malfunctions or system failures

To avoid malfunctions or system failures:

- ▶ Always have the prescribed service and maintenance work as well any required repairs carried out at a qualified specialist workshop.

⚠ WARNING Risk of accident or injury due to incorrect modifications on electronic component parts

Modification of electronic components, their software or wiring could impair their function

and/or the function of other networked component parts or safety-relevant systems.

This can endanger the operating safety of the vehicle.

- ▶ Never tamper with the wiring and electronic component parts or their software.
- ▶ You should have all work on electrical and electronic components carried out at a qualified specialist workshop.

Observe the "Vehicle electronics" section in "Technical data".

⚠ WARNING Risk of fire due to flammable materials on hot parts of the exhaust system

Flammable material such as leaves, grass or twigs may ignite if they come into contact with hot parts of the exhaust system.

- ▶ When driving on unpaved roads or off-road, regularly check the vehicle underside.
- ▶ Remove trapped plants or other flammable material, in particular.
- ▶ If there is damage, consult a qualified specialist workshop immediately.

⚠ NOTE Damage to the vehicle due to driving too fast and due to impacts to the vehicle underbody or suspension components

In the following situations, in particular, there is a risk of damage to the vehicle:

- The vehicle becomes grounded, e.g. on a high curb or an unpaved road
- The vehicle is driven too fast over an obstacle, e.g. a curb, speed bump or pothole
- A heavy object strikes the underbody or suspension components

In situations such as these, damage to the body, underbody, suspension components, wheels or tires may not be visible. Components damaged in this way can unexpectedly fail or, in the case of an accident, may no longer absorb the resulting force as intended.

If the underbody paneling is damaged, flammable materials such as leaves, grass or

twigs can collect between the underbody and the underbody paneling. These materials may ignite if they come into contact with hot parts of the exhaust system.

- ▶ Have the vehicle checked and repaired immediately at a qualified specialist workshop.

or

- ▶ If driving safety is impaired while continuing your journey, pull over and stop the vehicle immediately, while paying attention to road and traffic conditions, and contact a qualified specialist workshop.

Diagnostics connection

The diagnostics connection is a technical interface in the vehicle. It is used, for example, within the scope of repair and maintenance work or for reading out vehicle data by a specialist workshop. Diagnostic devices should therefore only be connected by a qualified specialist workshop.

⚠ WARNING Risk of accident due to connecting devices to the diagnostics connection

If you connect devices to the diagnostics connection of the vehicle, the function of vehicle systems and operating safety may be impaired.

- ▶ For safety reasons, we recommend that you only use and connect products approved by your authorized Mercedes-Benz Center.

⚠ WARNING Risk of accident due to objects in the driver's footwell

Objects in the driver's footwell may impede pedal travel or block a depressed pedal.

This jeopardizes the operating and road safety of the vehicle.

- ▶ Stow all objects in the vehicle securely so that they cannot get into the driver's footwell.
- ▶ Always install the floor mats securely and as prescribed in order to ensure that there is always sufficient room for the pedals.

- ▶ Do not use loose floor mats and do not place floor mats on top of one another.

! **NOTE** Battery discharging from using devices connected to the diagnostics connection

Using devices at the diagnostics connection drains the battery.

- ▶ Check the charge level of the battery.
- ▶ If the charge level is low, charge the battery, e.g. by driving a considerable distance.

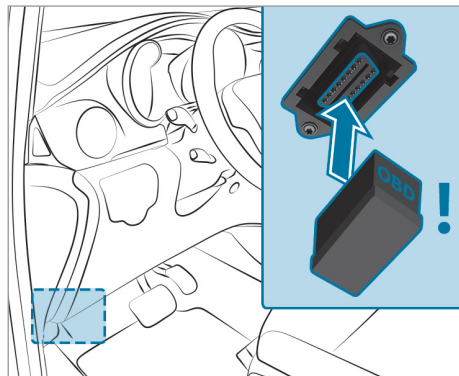

The connection and use of another device on the diagnostics connection can have the following effects:

- Malfunctions in the vehicle system
- Permanent damage to vehicle components

Please refer to the warranty terms and conditions regarding this.

Moreover, connecting equipment to the diagnostics connection can lead to emissions monitoring information being reset, for example. This may lead to the vehicle failing to meet the requirements of the next emissions inspection during the main inspection.

Notes on changes to the engine output

Output increases can:

- Change the emission values.
- Lead to malfunctions.
- Result in consequential damage.

The operating safety of the engine is not guaranteed in all situations.

Any tampering with the engine management in order to increase the engine output will lead to the loss of the New Vehicle Limited Warranty and other warranty entitlements.

If you sell the vehicle, inform the buyer of any alterations to the vehicle's engine output. This may constitute a punishable offense under national legislation.

Qualified specialist workshop

A qualified specialist workshop has the necessary special skills, tools and qualifications to correctly carry out any necessary work on your vehicle. This particularly applies to safety-relevant works.

Always have the following work on the vehicle carried out at a qualified specialist workshop:

- Safety-relevant works
- Service and maintenance work
- Repair work
- Modifications as well as installations and conversions
- Work on electronic components

Mercedes-Benz recommends that you use an authorized Mercedes-Benz Center for this purpose.

Vehicle registration

Mercedes-Benz may ask its service center to carry out technical inspections on certain vehicles. The quality or safety of the vehicle is improved as a result of the inspection.

Mercedes-Benz can only inform you about vehicle checks if it Mercedes-Benz has your registration data.

In the following cases your vehicle may not be registered to you yet:

- you did not purchase your vehicle at an authorised specialist dealer.
- your vehicle has not yet been inspected at an authorized Mercedes-Benz Center.

It is advisable to register your vehicle with an authorized Mercedes-Benz Center.

Inform Mercedes-Benz as soon as possible about any change in address or vehicle ownership.

You can do this, for example, at an authorized Mercedes-Benz Center.

Correct use of the vehicle

If you remove warning stickers, you or others may fail to recognize the dangers. Leave warning stickers in position.

Observe the following information in particular when operating the vehicle:

- Safety notes in these Operating Instructions
- Technical data for the vehicle
- Traffic rules and regulations
- Laws pertaining to motor vehicles and safety standards

⚠ WARNING Risk of fire and accident when transporting substances which are hazardous to health or react aggressively

Gases and fluids can even escape from containers which are fully closed.

This can adversely affect your concentration during the journey and your health. Electronic component parts may also experience malfunctions, short circuits or system failures.

▶ Do not stow or transport any substances which are hazardous to health and/or aggressively reactive in the vehicle interior.

These instructions must also be observed for vehicles where the cargo compartment is not fully separated from the cab.

Partition with door/window: always keep the door/window in the partition closed while transporting items.

Substances that constitute a health hazard or react aggressively include, for example:

- Solvents
- Fuel
- Oil and grease
- Cleaning agents
- Acid

Multi Purpose Vehicle

▲ WARNING Risk of accident when the center of gravity is too high

The vehicle may start to skid and rollover in the event of sudden steering maneuvers and/or when the vehicle's speed is not adapted to the road conditions.

▶ Always adapt your speed and driving style to the vehicle's driving characteristics and to the prevailing road and weather conditions.

Utility vehicles have a significantly higher rollover rate than other types of vehicles.

Unsafe operation of the vehicle can result in an accident or rollover, as well as serious or even fatal injuries.

In a rollover crash, an unbelted person is significantly more likely to die than a person wearing a seat belt.

You and all vehicle occupants should always wear seat belts.

Notes for persons with electronic medical aids

Despite careful development, Mercedes-Benz AG cannot completely rule out the interaction of vehicle systems with electronic medical aids such as cardiac pacemakers.

In addition, there are components built into the vehicle that, regardless of the operating status of your vehicle, can generate magnetic fields on a par with permanent magnets. These fields can be found, for example, in the area around the multimedia and sound system or also in the seating area, depending on the vehicle equipment.

For this reason, the following can occur in isolated cases, depending on the aids used:

- Medical aids malfunctioning
- Adverse health effects

Observe the notes and warnings of the manufacturer of the medical aids; if in doubt, contact the device manufacturer and/or your doctor. If there is continuing uncertainty concerning the possibility of medical aids malfunctioning, Mercedes-Benz AG recommends using only a few electrical vehicle systems and/or maintaining an appropriate distance from the components.

Only have repairs and maintenance work in the area of the following components carried out by a qualified specialist workshop:

- Vehicle components carrying live voltage
- Transmission antenna
- Multimedia system and sound system

If you have any queries or suggestions, consult a qualified specialist workshop.

Information on problems with your vehicle

If you should experience a problem with your vehicle, particularly one that you believe may affect its safe operation, we urge you to contact an authorized Mercedes-Benz Center immediately to have the problem diagnosed and rectified.

If the problem is not resolved to your satisfaction, please contact an authorized Mercedes-Benz Center again or write to one of the following addresses.

In the USA:

Daimler VANS USA, LLC
Customer Assistance Center
One Mercedes-Benz Drive
Sandy Springs, GA 30328

In Canada:

Mercedes-Benz Canada, Inc.
Customer Relations Department
98 Vanderhoof Avenue
Toronto, Ontario M4G 4C9

Reporting safety defects

USA only:

The following text is published as required of manufacturers under Title 49, Code of U.S. Federal Regulations, Part 575 pursuant to the "National Traffic and Motor Vehicle Safety Act of 1966".

If you believe that your vehicle has a defect which could cause a crash or could cause injury or death, you should immediately inform the National Highway Traffic Safety Administration (NHTSA) in addition to notifying Mercedes-Benz USA, LLC.

If NHTSA receives similar complaints, it may open an investigation, and if it finds that a safety defect exists in a group of vehicles, it may order a recall and remedy campaign. However, NHTSA

cannot become involved in individual problems between you, your dealer, or Mercedes-Benz USA, LLC.

To contact NHTSA, you may call the Vehicle Safety Hotline toll-free at 1-888-327-4236 (TTY: 1-800-424-9153); go to <https://www.safercar.gov>; or write to: Administrator, NHTSA, 400 Seventh Street, SW., Washington, DC 20590, USA.

You can find more information on vehicle safety at: <https://www.safercar.gov>

Canada only:

The following text is published as required of manufacturers under subsection 18.4 (4) of the Motor Vehicle Safety Regulations.

If you believe that your vehicle has a defect which could cause a crash or could cause injury or death, you should immediately inform Transport Canada in addition to notifying Mercedes-Benz Canada Inc.

If Transport Canada received similar complaints, it may open an investigation, and if it finds that a safety defect exists in a group of vehicles, it may order a recall and remedy campaign. However, Transport Canada cannot become involved in individual problems between you, your dealer, or Mercedes-Benz Canada Inc.

To contact Transport Canada, you may call the Defect Investigations and Recalls Division toll-free in Canada at 1-800-333-0510 or 819-994-3328 in the Gatineau-Ottawa area or internationally; you may also go to the following websites for more information:

- English: <https://www.tc.gc.ca/recalls>
- French: <https://www.tc.gc.ca/rappels>

Limited Warranty

! **NOTE** Damage to the vehicle arising from violation of these operating instructions.

Damage to the vehicle can arise from violation of these operating instructions.

Such damage is not covered by either the Limited Warranty or the new or used-vehicle warranty.

- ▶ Observe the instructions in these operating instructions on proper operation of your vehicle as well as regarding possible vehicle damage.

QR codes for rescue card

The QR code stickers are affixed to the B-pillar on the driver's and co-driver's side. In the event of an accident, emergency services can use the QR code to quickly determine the corresponding rescue card for your vehicle. The current rescue card contains, in compact form, the most important information about your vehicle e.g. the routing of electric cables.

Further information can be obtained at <https://www.mercedes-benz.de/qr-code>.

Data storage

Data processing in the vehicle

Electronic control units

Electronic control units are installed in your vehicle. Control units process data which, for example, they receive from vehicle sensors, generate themselves or exchange between themselves.

Some control units are required for the safe operation of your vehicle, some assist you when driving, such as driver assistance systems, while others enable comfort or infotainment functions.

The following provides you with general information regarding data processing in the vehicle. Additional information regarding exactly which data in your vehicle are collected, saved and transmitted to third parties, and for what purpose, can be found in the information directly related to the functional characteristics in question in their respective operating instructions. This information is also available online and, depending on the vehicle equipment, digitally.

Personal data

Every vehicle is identified by a unique vehicle identification number. Depending on the country, this vehicle identification number can be used by, for example, governmental authorities to determine the identity of the owner. There are other possibilities for using data collected from the vehicle to identify the owner or driver, such as the license plate number.

Therefore, data generated or processed by control units may be attributable to a person or, under certain conditions, become attributable to a person. Depending on which vehicle data are available, it may be possible to make inferences about, for example, your driving behavior, your location, your route or your use patterns.

Legal requirements regarding the disclosure of data

If legally required to do so, manufacturers are, in individual cases, legally obliged to provide governmental entities, upon request and to the extent required, data stored by the manufacturer. For example, this may be the case during the investigation of a criminal offense.

Governmental entities are themselves, in individual cases and within the applicable legal framework, authorized to read out data from the vehicle. In the case of an accident, information that can help with an investigation can, therefore, be taken from the airbag control unit, for example.

Operational data in the vehicle

This is data regarding the operation of the vehicle, which have been processed by control units.

This includes the following data, for example:

- Vehicle status information such as the speed, longitudinal acceleration, lateral acceleration, number of wheel revolutions or the fastened seat belts display
- Ambient conditions, such as temperature, rain sensor or distance sensor

Generally, these are volatile data and will not be stored beyond the period of operation but will only be processed within the vehicle itself. Control units, vehicle keys for example, often contain data memories. Their use permits the temporary or permanent documentation of technical information about the vehicle's operating state, component loads, maintenance requirements and technical events or malfunctions.

Depending on the technical equipment, the following data are stored:

- Operating status of system components, such as fill levels, tire pressure or battery status
- Malfunctions or faults in important system components, such as lights or brakes
- System reactions in special driving situations, such as airbag deployment or the intervention of stability control systems
- Information on events in which the vehicle is damaged

In certain cases, it may be required to store data that would have otherwise been temporary. This may be the case if the vehicle has detected a malfunction, for example.

If you use services, such as repair services and maintenance work, stored operational data as

well as the vehicle identification number can be read out and used. They can be read out by service network employees, such as workshops and manufacturers or third parties, such as breakdown services. The same is true in the case of warranty claims and quality assurance measures.

In general, the readout is performed via the legally prescribed port for the diagnostics connection in the vehicle. The operational data that are read out document technical states of the vehicle or of individual components and assist in the diagnosis of malfunctions, compliance with warranty obligations and quality improvement. To that end, these data, in particular information about component loads, technical events, malfunctions and other faults may be transmitted along with the vehicle identification number to the manufacturer. In addition, the manufacturer is subject to product liability. For this reason, the manufacturer also uses operational data from the vehicle, for example, for recalls. These data can also be used to examine the customer's warranty and guarantee claims.

Fault memories in the vehicle can be reset by a service outlet or at your request as part of repair or maintenance work.

Convenience and infotainment functions

You can store convenience settings and individual settings in the vehicle and change or reset them at any time.

Depending on the vehicle equipment, this includes the following settings, for example:

- Seat and steering wheel positions
- Suspension and climate control settings
- Individual settings, such as interior lighting

Depending on the selected equipment, you can import data into vehicle infotainment functions yourself.

Depending on the vehicle equipment, this includes the following data, for example:

- Multimedia data, such as music, films or photos for playback in an integrated multimedia system
- Address book data for use in an integrated hands-free system or an integrated navigation system
- Entered navigation destinations
- Data on the use of Internet services

These data for convenience and infotainment functions may be saved locally in the vehicle or they may be located on a device which you have connected to the vehicle, such as a smartphone, USB flash drive or MP3 player. If you have entered these data yourself, you can delete them at any time.

This data is transmitted from the vehicle to third parties only at your request. This applies, in particular, when you use online services in accordance with the settings that you have selected.

Smartphone integration (e.g. Android Auto or Apple CarPlay)

If your vehicle is equipped appropriately, you can connect your smartphone or another mobile end device to the vehicle. You can then control them by means of the control elements integrated in the vehicle. The smartphone's picture and sound can be output via the multimedia system. Simultaneously, specific items of information are transferred to your smartphone. Depending on the type of integration, this includes position data, day/night mode and other general vehicle statuses. For more information, please consult the vehicle Operating Instructions/infotainment system.

This integration allows the use of selected smartphone apps, such as navigation or music player apps. There is no additional interaction between the smartphone and the vehicle, particularly active access to vehicle data. The type of additional data processing is determined by the provider of the app being used. Which settings you can make, if any, depends on the specific app and the operating system of your smartphone.

Online services

Wireless network connection

If your vehicle has a wireless network connection, data can be exchanged between your vehicle and other systems. The wireless network connection is made possible by the vehicle's own transmitter and receiver or by a mobile end device that you have brought into the vehicle, for example, a smartphone. Online functions can be used via this wireless network connection. This includes online services and applications/apps provided to you by the manufacturer or by other providers.

Manufacturer's own services

Regarding the manufacturer's online services, the individual functions are described by the manufacturer in a suitable place, for example, in the

Operating Instructions or on the manufacturer's website, where the relevant data protection information is also given. Personal identification data may be used to provide online services. Data is exchanged via a secure connection, e.g. the manufacturer's designated IT systems. Any personal data which are collected, processed and used, other than for the provision of services, is done so exclusively on the basis of legal permission. This is the case, for example, for a legally prescribed emergency call system, a contractual agreement or when consent has been given.

You can have services and functions, some of which are subject to a fee, activated or deactivated. This excludes legally prescribed functions and services, such as an emergency call system.

Services of third parties

If you use online services from other providers (third parties), these services are the responsibility of the provider in question and subject to that provider's data protection conditions and terms of use. As a general rule, the manufacturer has no influence on the content exchanged.

For this reason, when services are provided by third parties, please ask the service provider in question for information about the type, extent and purpose of the collection and use of personal data.

Data protection rights

Depending on your country or the equipment and range of functions of your vehicle as well as the services you use and the services on offer, you are entitled to different data protection rights. Further information on data protection and your data protection rights can either be found on the manufacturer's website or you will receive this information as part of the various services and service offers. There, you will also find the contact information for the manufacturer and its data protection officer.

At a workshop, for example, with the support of a specialist and possibly for a fee, you can have data read out which is stored only locally in the vehicle.

Event Data Recorders

USA only:

This vehicle is equipped with an event data recorder (EDR). The main purpose of an EDR is to record, in certain crash or near crash-like situa-

tions, such as an air bag deployment or hitting a road obstacle, data that will assist in understanding how a vehicle's systems performed. The EDR is designed to record data related to vehicle dynamics and safety systems for a short period of time, typically 30 seconds or less.

The EDR in this vehicle is designed to record such data as:

- How various systems in your vehicle were operating;
- Whether or not the driver and passenger safety belts were buckled/fastened;
- How far (if at all) the driver was depressing the accelerator and/or brake pedal; and,
- How fast the vehicle was traveling.

These data can help provide a better understanding of the circumstances in which crashes and injuries occur. NOTE: EDR data are recorded by your vehicle only if a non-trivial crash situation occurs; no data are recorded by the EDR under normal driving conditions and no personal data (e.g. name, gender, age and crash location) are recorded. However, other parties such as law enforcement could combine the EDR data with the type of personally identifying data routinely acquired during a crash investigation.

Access to the vehicle and/or the EDR is needed to read data that is recorded by an EDR, and special equipment is required. In addition to the vehicle manufacturer, other parties that have the special equipment, such as law enforcement, can read the information by accessing the vehicle or the EDR.

EDR data may be used in civil and criminal matters as a tool in accident reconstruction, accident claims and vehicle safety. Since the Crash Data Retrieval CDR tool that is used to extract data from the EDR is commercially available, Daimler Vans USA, LLC ("DVUSA") expressly disclaims any and all liability arising from the extraction of this information by unauthorized Mercedes-Benz personnel.

DVUSA will not share EDR data with others without the consent of the vehicle owners or, if the vehicle is leased, without the consent of the lessee. Exceptions to this representation include responses to subpoenas by law enforcement; by federal, state or local government; in connection with or arising out of litigation involving DVUSA or its subsidiaries and affiliates; or, as required by law.

Warning: The EDR is a component of the Restraint System Module. Tampering with, altering, modifying or removing the EDR component may result in a malfunction of the Restraint System Module and other systems.

State laws or regulations regarding EDRs that conflict with federal regulation are pre-empted. This means that in the event of such conflict, the federal regulation governs. As of December 2016, 17 states have enacted laws relating to EDRs.

Copyright

Information on free and open-source software

Information on license for free and open-source software used in your vehicle can be found on the data storage medium in your vehicle document wallet and with updates on the following website: <https://www.mercedes-benz.com/opensource>.

Information on registered trademarks

- Bluetooth® is a registered trademark of Bluetooth SIG Inc.
- DTS™ is a registered trademark of DTS, Inc.
- Dolby® and MLP™ are registered trademarks of DOLBY Laboratories.
- ESP® and PRE-SAFE® are registered trademarks of Daimler AG.
- HomeLink® is a registered trademark of Genetex Corporation.
- iPod® and iTunes® are registered trademarks of Apple Inc.
- Burmester® is a registered trademark of Burmester Audiosysteme GmbH.
- Microsoft® and Windows Media® are registered trademarks of Microsoft Corporation.
- SIRIUS® is a registered trademark of Sirius XM Radio Inc.
- HD Radio™ is a registered trademark of iBiquity Digital Corporation.
- Gracernote® is a registered trademark of Gracernote, Inc.
- ZAGAT Survey® and related brands are registered trademarks of Zagat Survey, LLC.

Restraint system

Protection provided by the restraint system

The restraint system includes the following components:

- Seat belt system
- Airbags
- Child restraint system
- Child seat securing systems

The restraint system can help prevent the vehicle occupants from coming into contact with parts of the vehicle interior in the event of an accident. In the event of an accident, the restraint system can also reduce the forces to which the vehicle occupants are subjected.

Only a seat belt which is worn correctly can provide the intended level of protection. Depending on the detected accident situation, Emergency Tensioning Devices and/or airbags supplement the protection offered by a correctly worn seat belt. Emergency Tensioning Devices and/or airbags are not deployed in every accident.

In order for the restraint system to provide the intended level of protection, each vehicle occupant must observe the following information:

- Fasten seat belts correctly.
- Sit in an almost upright seat position with their back against the seat backrest.
- Sit with their feet resting on the floor, if possible.
- Always secure persons under 5 ft (1.50 m) tall in an additional restraint system suitable for this vehicle.

However, no system available today can completely eliminate injuries and fatalities in every accident situation. In particular, the seat belt and airbag generally do not protect against objects penetrating the vehicle from the outside. It is also not possible to completely rule out the risk of injury caused by the airbag deploying.

Limited protection provided by the restraint system

⚠ WARNING Risk of injury or death due to modifications to the restraint system

Vehicle occupants may no longer be protected as intended if alterations are made to the restraint system.

- ▶ Never alter the parts of the restraint system.
- ▶ Never tamper with the wiring or any electronic component parts or their software.

If it is necessary to adjust the vehicle to accommodate a person with disabilities, contact an authorized Mercedes-Benz Center for details.



USA only: contact our Customer Assistance Center at 1-877-762-8267.

Restraint system functionality

When the ignition is switched on, a self-test is performed, during which the  restraint system warning lamp lights up. It goes out no later than a few seconds after the vehicle is started. The components of the restraint system are then functional.

Restraint system malfunction

A malfunction has occurred in the restraint system in the following cases:

- The  restraint system warning lamp does not light up when the ignition is switched on.
- The  restraint system warning lamp lights up continuously or repeatedly during a journey.

⚠ WARNING Risk of injury due to malfunctions in the restraint system

Components in the restraint system may be activated unintentionally or not deploy as planned in an accident.

- ▶ Have the restraint system checked and repaired immediately at a qualified specialist workshop.

Function of the restraint system in an accident

How the restraint system works is determined by the severity of the impact detected and the type of accident anticipated:

- Frontal impact
- Rear impact
- Side impact
- Rollover

The activation thresholds for the components of the restraint system are determined based on the evaluation of the sensor values measured at various points in the vehicle. This process is pre-emptive in nature. The triggering/deployment of the components of the restraint system should take place in good time at the start of the collision.

Factors which can only be seen and measured after a collision has occurred cannot play a decisive role in airbag deployment. Nor do they provide an indication of airbag deployment.

The vehicle may be deformed significantly without an airbag being deployed. This is the case if only parts which are relatively easily deformed are affected and the rate of vehicle deceleration is not high. Conversely, an airbag may be deployed even though the vehicle suffers only minor deformation. If very rigid vehicle parts such as longitudinal members are hit, for example, the vehicle deceleration may be high enough for this to happen.

Depending on the detected deployment situation, the components of the restraint system can be activated or deployed independently of each other:

- Emergency Tensioning Device: frontal impact, rear impact, side impact, rollover
- Driver's airbag, co-driver airbag: frontal impact
- Side airbag: side impact
- Window curtain airbag: side impact, rollover, frontal impact

The co-driver airbag can only be deployed in the event of an accident if the PASSENGER AIR BAG OFF indicator lamp is off. If the co-driver seat is occupied, make sure, both before and during the journey, that the status of the co-driver airbag is correct (→ page 31).

⚠ WARNING Risk of burns from hot air bag components

The air bag parts are hot after an air bag has been deployed.

- ▶ Do not touch the air bag parts.
- ▶ Have a deployed air bag replaced at a qualified specialist workshop as soon as possible.

Mercedes-Benz recommends that you have the vehicle towed to a qualified specialist workshop

after an accident. Take this into account, particularly if an Emergency Tensioning Device is triggered or an airbag deployed.

If the Emergency Tensioning Devices are triggered or an airbag is deployed, you will hear a bang, and a small amount of powder may also be released:

- The bang will not generally affect your hearing.
- In general, the powder released is not hazardous to health but may cause short-term breathing difficulties to persons suffering from asthma or other pulmonary conditions.

Provided it is safe to do so, leave the vehicle immediately or open the window in order to prevent breathing difficulties.

Airbags and pyrotechnic Emergency Tensioning Devices contain perchlorate material, which may require special handling or environmental protection measures. National guidelines regarding waste disposal must be observed. In California see <https://dtsc.ca.gov/>. You can use the search function to find information on perchlorate, for example.

Seat belts

Protection provided by the seat belt

Always fasten your seat belt correctly before starting a journey. Only a seat belt which is worn correctly can provide the intended level of protection.

⚠ WARNING Risk of injury or death due to incorrectly fastened seat belt

If the seat belt is not worn correctly, it cannot perform its intended protective function.

In addition, an incorrectly fastened seat belt can also cause injuries, for example, in the event of an accident or when braking or changing direction suddenly.

- ▶ Always ensure that all vehicle occupants have their seat belts fastened correctly and are sitting properly.

Always observe the instructions about the correct driver's seat position and adjusting the seat (→ page 62).

In order for the correctly worn seat belt to provide the intended level of protection, each vehicle occupant must observe the following information:

- The seat belt must not be twisted and must fit tightly and snugly across the body.
- The seat belt must be routed across the center of the shoulder and as low down across the hips as possible.
- The shoulder section of the seat belt should not touch your neck nor be routed under your arm or behind your back.
- Avoid wearing bulky clothing, e.g. a winter coat.
- Push the lap belt down as far as possible across your hips and pull tight with the shoulder section of the belt. Never route the lap belt across your abdomen.

Pregnant women must also take particular care with this.

- Never route the seat belt across sharp, pointed, abrasive or fragile objects.
- Only one person should use each seat belt at any one time. Infants and children must never travel sitting on the lap of a vehicle occupant.
- Never secure objects with a seat belt if the seat belt is being used by one of the vehicle's occupants. Always observe the instructions for loading the vehicle when securing objects, luggage or loads (→ page 166).

Also ensure that no objects, e.g. a cushion, are ever placed between a person and the seat.

The seat belts on the following seats are equipped with a special seat belt retractor:

- Co-driver seat
- Rear seats

Activate or deactivate the special seat belt retractor of the seat belt (→ page 36).

If children are traveling in the vehicle, always observe the instructions and safety notes on "Children in the vehicle" (→ page 34).

Limitations of the protection provided by the seat belt

⚠ WARNING Risk of injury or death due to an incorrect seat position

The seat belt does not offer the intended level of protection if you have not moved the seat backrest to an almost vertical position.

In particular, you could slip beneath the seat-belt and become injured.

- ▶ Adjust the seat properly before beginning your journey.
- ▶ Always ensure that the seat backrest is in an almost vertical position and that the shoulder belt is routed across the center of your shoulder.

⚠ WARNING Risk of injury or death when additional restraint systems are not used for persons with a smaller stature

Persons under 5 ft (1.50 m) tall cannot wear the seat belt correctly without a suitable additional restraint system.

- ▶ Always secure persons under 5 ft (1.50 m) tall in a suitable restraint system.

⚠ WARNING Risk of injury or death due to damaged or modified seat belts

Seat belts cannot provide protection in the following situations:

- The seat belt is damaged, has been modified, is extremely dirty, bleached or dyed
- The seat belt buckle is damaged or extremely dirty
- Modifications have been made to the Emergency Tensioning Device, seat belt anchorage or seat belt retractor

Seat belts may sustain non-visible damage in an accident, e.g. due to glass splinters.

Modified or damaged seat belts could tear or fail in the event of an accident, for example.

Modified Emergency Tensioning Devices could accidentally trigger or fail to function as intended.

- ▶ Never modify the seat belt system, for example the seat belt, seat belt buckle,

Emergency Tensioning Device, seat belt anchorage and seat belt retractor.

- ▶ Make sure that the seat belts are undamaged, not worn and clean.
- ▶ Always have the seat belts checked immediately after an accident at a qualified specialist workshop.

Mercedes-Benz recommends that you use seat belts which have been approved for your vehicle by Mercedes-Benz.

⚠ WARNING Risk of injury or death from deployed pyrotechnic Emergency Tensioning Devices

Pyrotechnic Emergency Tensioning Devices that have been deployed are no longer operational and are unable to perform their intended protective function.

- ▶ Therefore, have deployed pyrotechnic Emergency Tensioning Devices immediately replaced at a qualified specialist workshop.

Mercedes-Benz recommends that you have the vehicle towed to a qualified specialist workshop after an accident.

! **NOTE** Damage caused by trapping the seat belt

If an unused seat belt is not fully retracted, it may become trapped in the door or in the seat mechanism.

- ▶ Always ensure that an unused seat belt is fully retracted.

Fastening and adjusting seat belts

If the seat belt is pulled quickly or sharply, the seat belt retractor locks. The seat belt strap cannot be pulled out any further.

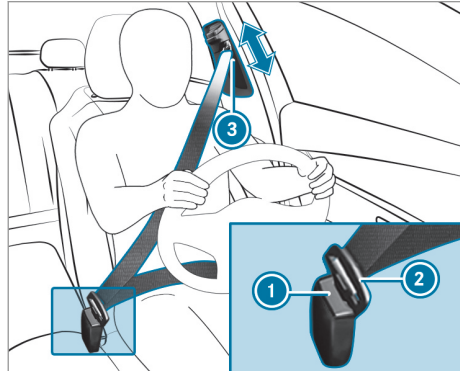

- ▶ Always engage seat belt tongue (2) of the seat belt into seat belt buckle (1) of the corresponding seat.
- ▶ Press and hold the seat belt outlet release and slide seat belt outlet (3) into the desired position.
- ▶ Let go of the seat belt outlet release and ensure that seat belt outlet (3) locks into position.

Vehicles with automatic co-driver's airbag shutoff:

! **NOTE** Deployment of the Emergency Tensioning Device and side air bag when the front passenger seat is unoccupied

If the seat belt tongue is engaged in the seat belt buckle of the unoccupied front passenger seat, the Emergency Tensioning Device and the side air bag may also deploy in the event of an accident along with other systems.

- ▶ Only one person should use each seat belt at any one time.

Vehicles without automatic co-driver's airbag shutoff:

! **NOTE** Deployment of the Emergency Tensioning Device when the front-passenger seat is unoccupied

If the seat belt tongue is engaged in the seat belt buckle of the unoccupied front-passenger seat, the Emergency Tensioning Device may also deploy in the event of an accident along with other systems.

- ▶ Only one person should use each seat belt at any one time.

Releasing the seat belt

- ▶ Press the release button in the seat belt buckle and guide the seat belt back with the seat belt tongue.

Function of the seat belt warning system for driver and co-driver

The  seat belt warning lamp in the Instrument Display reminds you that all vehicle occupants must fasten their seat belts correctly.

The  seat belt warning lamp lights up for six seconds every time after switching on the ignition.

A warning tone may also sound.

After the vehicle is started, the seat belt warning goes out as soon as the driver's and the co-driver seat belts are fastened.

While driving, the seat belt warning lights up in the following cases:

- If the vehicle's speed is higher than 15 mph (25 km/h) and the driver's or co-driver's seat belt is not fastened
- If the driver or co-driver unfasten their seat belt during the journey

Airbags

Overview of airbags

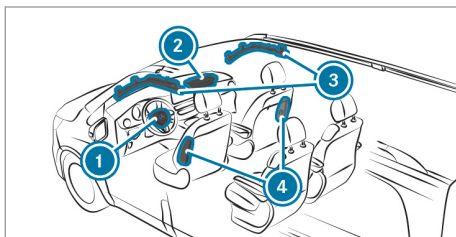

Example: vehicles with window curtain airbag above front door

- ① Driver's airbag
- ② Co-driver airbag
- ③ Window curtain airbag
- ④ Side airbag

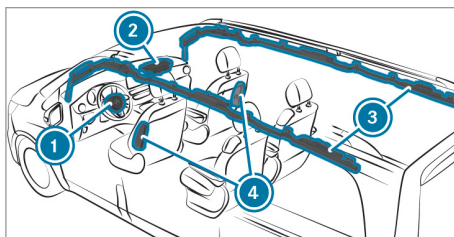

Example: vehicles with window curtain airbag for all rows of seats

- ① Driver's airbag
- ② Co-driver airbag
- ③ Window curtain airbag
- ④ Side airbag

An airbag's installation location is identified by the label AIRBAG.

When enabled, an airbag can provide additional protection for the respective vehicle occupant.

Possible protection of each airbag:

- Driver's airbag, co-driver airbag: head and ribcage
- Window curtain airbag: head
- Side airbag: ribcage and pelvis

⚠ WARNING Risk of injury or death if the co-driver airbag is enabled

If the co-driver airbag is enabled, a child on the co-driver seat may be struck by the co-driver airbag during an accident.

NEVER use a rearward-facing child restraint system on a seat with an ENABLED FRONT AIRBAG; DEATH or SERIOUS INJURY to the CHILD can occur.

When installing a child restraint system to the co-driver seat, observe the vehicle-specific information (→ page 39). Also be sure to observe the notes on rearward-facing or forward-facing child restraint systems on the co-driver seat.

Information on the automatic co-driver airbag shutoff

The co-driver airbag can only be deployed in the event of an accident if the PASSENGER AIR BAG OFF indicator lamp is off. If the co-driver seat is occupied, make sure, both before and during the journey, that the status of the co-driver airbag is correct (→ page 31).

I NOTE Important points to remember if the front passenger seat is unoccupied

In an accident, the components of the restraint system may deploy unnecessarily on the front passenger side if:

- There are heavy objects on the front passenger seat.
 - The seat belt tongue is engaged in the seat belt buckle of the front passenger seat and the front passenger seat is unoccupied.
- ▶ Stow objects in a suitable place.
- ▶ Only one person should use each seat belt at any one time.

Protection provided by the airbags

Depending on the accident situation, an airbag may supplement the protection offered by a correctly fastened seat belt.

⚠ WARNING Risk of injury or death due to an incorrect seat position

If you deviate from the correct seat position, the airbag cannot perform its intended protective function.

Each vehicle occupant must make sure of the following:

- Fasten seat belts correctly. Pregnant women must take particular care to ensure that the lap belt never lies across the abdomen.
 - Adopt the correct seat position and keep as far away as possible from the airbags.
 - Observe the following information.
- ▶ Always make sure that there are no objects between the airbag and vehicle occupant.

To avoid the risks resulting from the deployment of an airbag, each vehicle occupant must observe the following information in particular:

- Before starting your journey, adjust your seat correctly; both the driver's and co-driver seat should be moved as far back as possible.

When doing so, always observe the information on the correct driver's seat position (→ page 62).

- Only hold the steering wheel by the steering wheel rim. This allows the airbag to be fully deployed.
- Always lean against the seat backrest when the vehicle is in motion. Do not lean forwards or against the door or side window. You may otherwise be in the deployment area of the airbags.
- Always keep your feet on the floor. Do not put your feet on the cockpit, for example. Your feet may otherwise be in the deployment area of the airbag.
- If children are traveling in the vehicle, observe the additional notes (→ page 34).
- Always stow and secure objects correctly.

Objects in the vehicle interior may prevent an airbag from functioning correctly. Each vehicle occupant must always make sure of the following in particular:

- There are no people, animals or objects between the vehicle occupants and an airbag.
- There are no objects between the seat, door and door pillar (B-pillar).
- There are no hard objects, e.g. coat hangers, hanging on the grab handles or coat hooks.
- There are no accessory parts, such as mobile navigation devices, mobile phones or cup holders, attached to the vehicle within the deployment area of an airbag, e.g. on the cockpit, on the door, on the side window or on the side trim.

In addition, no connecting cables, tensioning straps or retaining straps must be routed or attached to the vehicle within the deployment area of an airbag. Always comply with the accessory manufacturer's installation instructions and, in particular, the notes on suitable places for installation.

- There are no heavy, sharp-edged or fragile objects in the pockets of your clothing. Store such objects in a suitable place.

Limited protection provided by airbags

⚠ WARNING Risk of injury due to modifications to the cover of an airbag

If you modify the cover of an airbag or affix objects such as stickers to it, the airbag may no longer function correctly.

- ▶ Never modify the cover of an airbag and do not affix objects to it.

An airbag's installation location is identified by the label AIRBAG (→ page 28).

⚠ WARNING Risk of injury or death due to the use of unsuitable seat covers

Due to unsuitable seat covers, the airbags cannot protect vehicle occupants as intended.

In addition, the operation of the automatic front passenger airbag shutoff could be restricted.

- ▶ You should only use seat covers that have been approved for the corresponding seats by Mercedes-Benz.

Vehicles with window curtain airbags in all rows of seats:

⚠ WARNING Risk of injury due to malfunctioning sensors in the door

The function of the airbags can be impaired due to modifications or incorrect work performed on the doors or door trim, or if the doors are damaged.

- ▶ Never modify the doors or parts of the doors.
- ▶ Always have work on the doors or door trim carried out at a qualified specialist workshop.

⚠ WARNING Risk of injury due to deployed airbag

A deployed airbag no longer offers any protection.

- ▶ Have the vehicle towed to a qualified specialist workshop in order to have the deployed airbag replaced.

Have deployed airbags replaced immediately.

Status of the co-driver airbag

Function of the automatic co-driver airbag shutoff

The automatic co-driver airbag shutoff is able to detect whether the co-driver seat is occupied by a person or a child restraint system. The co-driver airbag is enabled or disabled accordingly.

⚠ WARNING Risk of injury or death due to objects under the co-driver seat

Objects trapped under the co-driver seat can interfere with the function of the automatic co-driver airbag shutoff or damage the system.

- ▶ Do not store any objects under the co-driver seat.
- ▶ When the co-driver seat is occupied, make sure that no objects are trapped under the co-driver seat.

When installing a child restraint system on the co-driver seat, always make sure of the following:

- Ensure that the child restraint system is positioned correctly (→ page 33).
- Always comply with the child restraint system manufacturer's installation instructions.
- Never place objects (e.g. cushions) under or behind the child restraint system.
- The entire base of the child restraint system must always rest on the sitting surface of the co-driver seat.
- The backrest of the forward-facing child restraint system must, as far as possible, be resting on the seat backrest of the co-driver seat.
- The child restraint system must not touch the roof or be put under strain by the head restraints. Adjust the seat backrest inclination and the head restraint setting accordingly.

⚠ WARNING Risk of injury or death due to objects between the seat surface and the child restraint system

Objects between the sitting surface and the child restraint system could affect the function of the automatic co-driver airbag shutoff.

- ▶ Do not place any objects between the sitting surface and the child restraint system.

- ▶ The entire base of the child restraint system must always rest on the sitting surface of the co-driver seat.
- ▶ The backrest of the forward-facing child restraint system must, as far as possible, be resting on the seat backrest of the co-driver seat.
- ▶ Always comply with the child restraint system manufacturer's installation instructions.

A person on the co-driver seat must observe the following information:

- Fasten seat belts correctly (→ page 25).
- Sit in an almost upright seat position with their back against the seat backrest.
- Sit with their feet resting on the floor, if possible.

The co-driver airbag may otherwise be disabled by mistake, for example, in the following situations:

- The co-driver transfers their weight by supporting themselves on a vehicle armrest.
- The co-driver sits in such a way that their weight is raised from the sitting surface.

⚠ WARNING Risk of injury or death due to a disabled front passenger airbag

The front passenger airbag is disabled when the PASSENGER AIR BAG OFF indicator lamp is lit.

A person in the front passenger seat could then, for example, come into contact with the vehicle interior, especially if the person is sitting too close to the cockpit.

If the front passenger seat is occupied, always ensure that:

- The classification of the person in the front passenger seat is correct and the front passenger airbag is enabled or disabled in accordance with the person in the front passenger seat.
 - The front passenger seat has been moved as far back as possible.
 - The person is seated correctly.
- ▶ Both before and during the journey, ensure that the status of the front passenger airbag is correct.

If the co-driver seat is occupied, the classification of the person or child restraint system on the co-driver seat takes place after the co-driver airbag shutoff self-test. The PASSENGER AIR BAG OFF indicator lamp displays the status of the co-driver airbag.

Always observe the notes on the function of the PASSENGER AIR BAG OFF indicator lamp (→ page 31).

Function of the PASSENGER AIR BAG indicator lamps



Self-test of automatic co-driver airbag shutoff

The PASSENGER AIR BAG OFF indicator lamp lights up for approximately six seconds during the self-test when the ignition is switched on.

The status of the co-driver airbag is displayed after the self-test:

- PASSENGER AIR BAG OFF is not lit: the co-driver airbag may deploy during an accident.
- PASSENGER AIR BAG OFF lights up continuously: the co-driver airbag is disabled. It will not be deployed in the event of an accident.

If the PASSENGER AIR BAG OFF indicator lamp and the  restraint system warning lamp light up simultaneously, the co-driver seat may not be used. Also in this case, do not install a child restraint system on the co-driver seat. Have the automatic co-driver airbag shutoff checked and repaired immediately at a qualified specialist workshop.

Status indicator

If the co-driver seat is occupied, ensure, both before and during the journey, that the status of the co-driver airbag is correct for the current situation.

After installing a rearward-facing child restraint system on the co-driver seat:

PASSENGER AIR BAG OFF must be lit continuously.

⚠ WARNING Risk of injury or death when using a rearward-facing child restraint system while the front passenger airbag is enabled

If you secure a child in a rearward-facing child restraint system on the front passenger seat and the PASSENGER AIR BAG OFF indicator lamp is off, the front passenger airbag can deploy in the event of an accident.

The child could be struck by the airbag.

Always ensure that the front passenger airbag is disabled. The PASSENGER AIR BAG OFF indicator lamp must be lit.

NEVER use a rearward-facing child restraint system on a seat with an ENABLED FRONT AIRBAG. This can result in the DEATH of or SERIOUS INJURY to the CHILD.

When installing a child restraint system on the co-driver seat, observe the vehicle-specific information (→ page 39).

Depending on the child restraint system and the stature of the child, the PASSENGER AIR BAG OFF indicator lamp may be off. In this case, do not install the rearward-facing child restraint system on the co-driver seat.

Instead, install the rearward-facing child restraint system on a suitable rear seat.

After installing a forward-facing child restraint system on the co-driver seat:

depending on the child restraint system and the stature of the child, PASSENGER AIR BAG OFF may be lit continuously or be off. Always observe the following information.

⚠ WARNING Risk of injury or death due to incorrect positioning of the forward-facing child restraint system

If you secure a child in a forward-facing child restraint system on the front passenger seat that is positioned too close to the cockpit, in the event of an accident, the child could:

- come into contact with the vehicle interior if the PASSENGER AIR BAG OFF indicator lamp is lit, for example
- be struck by the airbag if the PASSENGER AIR BAG OFF indicator lamp is off.

▶ Always move the front passenger seat as far back as possible and fully retract the seat cushion length adjustment. While doing so, always make sure that the shoulder belt strap is correctly routed from the seat belt outlet of the vehicle to the shoulder belt guide on the child restraint system. The shoulder belt strap must be routed forwards and downwards from the seat belt outlet. If necessary, adjust the seat belt outlet and the front passenger seat accordingly.

▶ Always comply with the child restraint system manufacturer's installation instructions.

When installing a child restraint system on the co-driver seat, observe the vehicle-specific information (→ page 39).

If a person is sitting on the co-driver seat:

PASSENGER AIR BAG OFF may be lit continuously or be off, depending on the person's stature.

A person on the co-driver seat must always observe the following information:

- If the co-driver seat is occupied by an adult or a person with a stature corresponding to that of an adult, the PASSENGER AIR BAG OFF indicator lamp must be off. This indicates that the co-driver airbag is enabled.

If the PASSENGER AIR BAG OFF indicator lamp is lit continuously, an adult or person with a build corresponding to that of an adult should not use the co-driver seat.

Instead, they should use a rear seat.

- If the co-driver seat is occupied by a person of smaller stature (e.g. a teenager or small adult), the PASSENGER AIR BAG OFF indicator lamp either lights up continuously or

remains off, depending on the result of the classification.

- If the PASSENGER AIR BAG OFF indicator lamp is off: move the co-driver seat as far back as possible, or the person of smaller stature should use a rear seat.
- If the PASSENGER AIR BAG OFF indicator lamp is lit continuously: the person of smaller stature should not use the co-driver seat.

⚠ WARNING Risk of injury or death when the PASSENGER AIR BAG OFF indicator lamp is lit

If the PASSENGER AIR BAG OFF indicator lamp remains lit after the self-test, the front passenger airbag is disabled.

If the front passenger seat is occupied, always ensure that:

- The classification of the person in the front passenger seat is correct and the front passenger airbag is enabled or disabled in accordance with the person in the front passenger seat.
- The person is seated properly with a correctly fastened seat belt.
- The front passenger seat has been moved as far back as possible.

Be sure to also observe the following further related subjects:

- Child restraint system on the co-driver seat (→ page 39).

Automatic measures after an accident

Depending on the type and severity of the accident, and depending on the vehicle's equipment, the following measures can be implemented, for example:

- Activating the hazard warning lights
- Triggering an automatic emergency call (→ page 187)
- Switching off the engine

To restart the vehicle, switch the ignition off and switch it back on (→ page 97). Depending on the type and severity of the accident, it may be possible that the vehicle can no longer be started.

- switching off the fuel supply

- Unlocking the vehicle doors
- Lowering the front side windows
- Switching on the interior lighting

Safely transporting children in the vehicle

Always observe when children are traveling in the vehicle

- ⓘ Always observe the safety notes relevant to the situation. In doing so, you will be able to identify possible risks and avoid dangers when children are traveling in the vehicle (→ page 34).

Be diligent

Bear in mind that negligence when securing a child in the child restraint system may have serious consequences. Always be diligent and secure a child carefully before each journey.

To improve protection for children younger than 12 years old or under 5 ft (1.50 m) in height, Mercedes-Benz recommends you observe the following information:

- Always secure the child in a child restraint system suitable for this Mercedes-Benz vehicle.
- The child restraint system must be appropriate to the age, weight and size of the child.
- The vehicle seat must be suitable for installing a child restraint system.

Accident statistics show that children secured on the rear seats are generally safer than children secured on the front seats. For this reason, Mercedes-Benz strongly advises that you install a child restraint system on a rear seat.

The generic term child restraint system

The generic term child restraint system is used in this set of Operating Instructions. A child restraint system is, for example:

- a baby car seat
- a rearward-facing child seat
- a forward-facing child seat
- a child booster seat with a backrest and seat belt guides

The child restraint system must be appropriate to the age, weight and size of the child.

Observe laws and regulations

Always observe the legal requirements when using a child restraint system in the vehicle.

Observe standards for child restraint systems

All child restraint systems must meet the following standards:

- U.S. Federal Motor Vehicle Safety Standards 213 and 225
- Canadian Motor Vehicle Safety Standards 213 and 210.2

Confirmation that the child restraint system complies with the standards can be found on an instruction label on the child restraint system. This confirmation can also be found in the installation instructions that are included with the child restraint system.

Detecting risks, avoiding danger

Securing systems for child restraint systems in the vehicle

Only use the following securing systems for child restraint systems:

- The LATCH-type (ISOFIX) securing rings
- The seat belt system of the vehicle
- The Top Tether anchorages

Installing a LATCH-type (ISOFIX) child restraint system is favored.

Simply attaching to the securing rings on the vehicle can reduce the risk of installing the child restraint system incorrectly.

When securing a child with the integrated seat belt of the LATCH-type (ISOFIX) child restraint system, always comply with the permissible gross weight for the child and child restraint system (→ page 37).

A booster seat may be necessary to achieve proper seat belt positioning for children over 40 lbs (18 kg) in weight or until they reach a height where a three-point seat belt can be fastened properly without a booster seat.

Mercedes-Benz recommends a child booster seat with a backrest and seat belt guides.

Advantage of a rearward-facing child restraint system

It is preferable to transport a baby or a small child in a suitable rearward-facing child restraint system. In this case, the child sits in the opposite

direction to the direction of travel and faces backwards.

Babies and small children have comparatively weak neck muscles in relation to the size and weight of their head. The risk of injury to the cervical spine during an accident can be reduced in a rearward-facing child restraint system.

Always secure a child restraint system correctly

⚠ WARNING Risk of injury or death due to incorrect installation of the child restraint system

The child can then not be protected or restrained as intended.

- ▶ Be sure to comply with the manufacturer's installation instructions for the child restraint system and its correct use.
- ▶ Make sure that the entire base of the child restraint system always rests on the sitting surface of the seat.
- ▶ Never place objects (e.g. cushions) under or behind the child restraint system.
- ▶ Use child restraint systems only with the original cover designed for them.
- ▶ Always replace damaged covers with genuine covers.

⚠ WARNING Risk of injury or death due to unsecured child restraint systems in the vehicle

If the child restraint system is incorrectly installed or not secured, it can come loose.

The child restraint system could be flung around and hit vehicle occupants.

- ▶ Always install child restraint systems correctly, even when not in use.
- ▶ Always comply with the child restraint system manufacturer's installation instructions.

- Always observe the child restraint system manufacturer's installation and operating

instructions as well as the vehicle-specific information:

- Installing the LATCH-type (ISOFIX) child restraint system on the rear seat (→ page 37).
- Securing the child restraint system with the seat belt on the rear seat (→ page 38).
- Securing the child restraint system with the seat belt on the co-driver seat (→ page 39). Observe the specific instructions for the rearward-facing and forward-facing child restraint systems (→ page 39).

If the co-driver seat is occupied, ensure, both before and during the journey, that the status of the co-driver airbag is correct for the current situation (→ page 31).

- Observe the warning labels in the vehicle interior and on the child restraint system.
- Also secure Top Tether if present.

Do not modify the child restraint system

⚠ WARNING Risk of injury due to modifications to the child restraint system

The child restraint system can no longer function properly. This poses an increased risk of injury.

- ▶ Never modify a child restraint system.
- ▶ Only affix accessories which have been specially approved for this child restraint system by the child restraint system's manufacturer.

Only use child restraint systems which are in proper working condition

⚠ WARNING Risk of injury or death caused by the use of damaged child restraint systems

Child restraint systems or their retaining systems that have been subjected to stress in an accident may not be able to perform their intended protective function.

It may be the case that the child cannot be properly restrained.

- ▶ Always immediately replace child restraint systems that have been damaged or involved in an accident.

- ▶ Have the securing systems for the child restraint systems checked at a qualified specialist workshop before installing a child restraint system again.

Avoid direct sunlight

⚠ WARNING Risk of burns when the child seat is exposed to direct sunlight

If the child restraint system is exposed to direct sunlight or heat, parts could heat up.

Children could suffer burns from these parts, particularly on the metallic parts of the child restraint system.

- ▶ Always make sure that the child restraint system is not exposed to direct sunlight.
- ▶ Protect the child restraint system, e.g. with a blanket.
- ▶ If the child restraint system has been exposed to direct sunlight, allow it to cool before securing a child in it.
- ▶ Never leave children unattended in the vehicle.

Observe when stopping or parking

⚠ WARNING Risk of accident and injury due to children left unattended in the vehicle

If children are left unsupervised in the vehicle, they could, in particular:

- Open doors, thereby endangering other persons or road users.
- Get out and be struck by oncoming traffic.
- Operate vehicle equipment and become trapped, for example.







In addition, the children could also set the vehicle in motion, for example by:

- Releasing the parking brake.
- Changing the transmission position.
- Starting the vehicle.
- ▶ Never leave children unattended in the vehicle.
- ▶ When leaving the vehicle, always take the SmartKey with you and lock the vehicle.

- ▶ Keep the vehicle SmartKey out of reach of children.

Overview of suitable seats in the vehicle for installing a child restraint system

Securing systems for child restraint systems

Vehicle seat		
Left/right rear seat (second and third seat row)	Preferred securing system:  LATCH-type (ISOFIX) child seat securing system  Also secure Top Tether if present (→ page 38)	Alternative securing system:  Seat belt on vehicle seat
Co-driver seat	Securing system:  Seat belt on vehicle seat	Always observe the following: <ul style="list-style-type: none"> • If the co-driver seat is occupied, ensure, both before and during the journey, that the status of the co-driver airbag is correct for the current situation.
Center rear seat (second and third seat row)	Securing system:  Seat belt on vehicle seat  Also secure Top Tether if present (→ page 38)	

Activating or deactivating the special seat belt retractor of the seat belt

⚠ WARNING Risk of injury or death if a seat belt is unfastened while the vehicle is in motion

If the seat belt is released while the vehicle is in motion, the child safety lock is deactivated and the child restraint system is no longer correctly secured. The seat belt is drawn in slightly by the inertia reel and cannot be immediately closed again.

- ▶ Stop the vehicle immediately in accordance with the traffic conditions.
- ▶ Activate the special seat belt retractor again and correctly secure the child restraint system.

Requirements

When activated, the special seat belt retractor ensures that the seat belts of the co-driver seat and rear seats do not slacken once the child restraint system is secured.

The seat belts on the following seats are equipped with a special seat belt retractor:

- Co-driver seat
- Rear seats

Installing a child restraint system

- ▶ When installing a child restraint system, always observe the manufacturer's installation and operating instructions for the child restraint system used, as well as the notes in these Operating Instructions.
- ▶ Pull the seat belt smoothly from the seat belt outlet.
- ▶ Engage the seat belt tongue in the seat belt buckle.

Activating the special seat belt retractor

- ▶ Extend the seat belt fully and then allow the inertia reel to retract the belt. When the special seat belt retractor is activated, you should hear a ratcheting sound.
- ▶ Push the child restraint system down until the seat belt is tight.

Deactivating the special seat belt retractor

- ▶ Press the release button of the seat belt buckle.
- ▶ Hold the seat belt tongue and guide back to the seat belt outlet.

Installing a LATCH-type (ISOFIX) child restraint system on the rear seat

Installing a LATCH-type (ISOFIX) child restraint system on the rear seat

⚠ WARNING Risk of injury or death if the permissible gross mass of the child and child restraint system together is exceeded.

Too much load may be placed on the LATCH-type (ISOFIX) child restraint system and the child may not be restrained correctly in the event of an accident, for example.

- ▶ If the child and the child restraint system together weigh more than the permissible gross mass of 73 lb (33 kg), only use a LATCH-type (ISOFIX) child restraint system with which the child is secured with the vehicle seat belt.
- ▶ Also secure the child restraint system with the Top Tether belt, if available.

Always comply with the information about the mass of the child restraint system:

- in the manufacturer's installation and operating instructions for the child restraint system used
- on a label on the child restraint system, if available

Check regularly that the permissible gross mass of the child plus the child restraint system is not exceeded.

When you install a child restraint system, observe the following:

- ✔ Always observe the correct use and suitability of the seats for attaching a child restraint system.
- ✔ Always observe the manufacturer's installation and operating instructions for the child restraint system used.
- ✔ Make sure that the child's feet do not touch the front seat. If necessary, move the front seat slightly forwards.

 When installing a LATCH-type (ISOFIX) child restraint system, also observe the following:

- ✔ **When using a Group 0/0+ baby car seat and a Group I rearward-facing child restraint system on a rear seat:** adjust the front seat so that the seat does not touch the child restraint system.
- ✔ Move the rear seat backrest to an upright position before you install the child seat. Do not adjust the seat backrest when a LATCH-type (ISOFIX) child restraint system is installed.
- ✔ For certain child restraint systems in weight Group II or III, there may be restrictions on the maximum size setting, e.g. due to possible contact with the roof.
- ✔ Do not put the child restraint system under strain between the roof and the sitting surface and/or install it facing the wrong direction.
- ✔ Do not put the child restraint system under strain by the head restraint. Adjust the head restraints as appropriate.

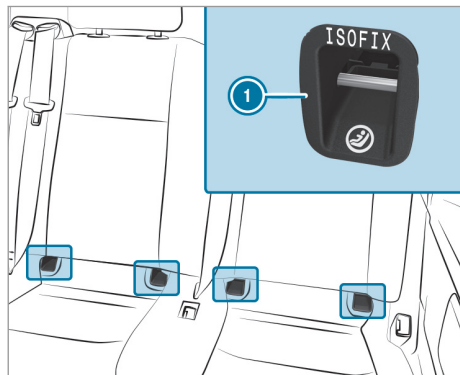

① LATCH-type (ISOFIX) mounting brackets

Before every journey, make sure that the LATCH-type (ISOFIX) child restraint system is engaged correctly in both mounting brackets in the vehicle.

⚠ NOTE Damage to the seat belt for the center seat during installation of the child restraint system

- ▶ Make sure that the seat belt is not trapped.

- ▶ Attach the LATCH-type (ISOFIX) child restraint system to both mounting brackets ① in the vehicle.

Securing Top Tether

-  If the child restraint system is equipped with a Top Tether belt:

The risk of injury can be reduced by Top Tether. The Top Tether belt enables an additional connection between the child restraint system attached with LATCH-type (ISOFIX) and the vehicle.

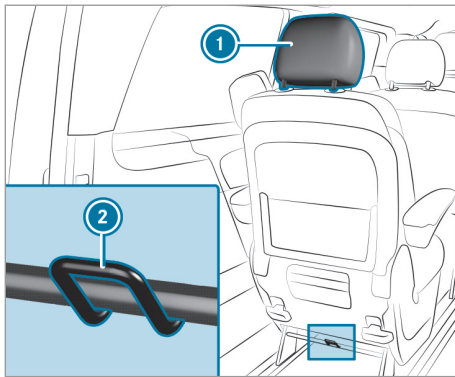

Example

Top Tether anchorage ② is on the lower part of the rear seat on the cross strut between the seats or bench seat legs.

- ▶ Install the LATCH-type (ISOFIX) child restraint system with Top Tether. Comply with the child restraint system manufacturer's installation instructions.

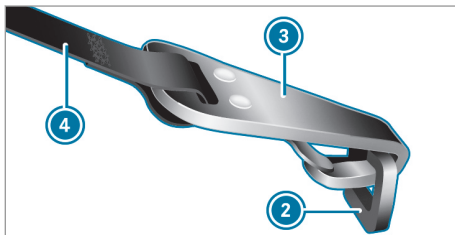

- ▶ Guide Top Tether belt ④ under head restraint ① between the two head restraint bars.
- ▶ Hook Top Tether hook ③ into Top Tether anchorage ② without twisting.

- ▶ Tension Top Tether belt ④. Comply with the child restraint system manufacturer's installation instructions.

Securing the child restraint system with the seat belt

Securing the child restraint system with the seat belt on the rear seat

When installing a belt-secured child restraint system, observe the following:

- Always comply with the manufacturer's installation and operating instructions for the child restraint system used.
- When using a category 0/0+ baby car seat and a category I rearward-facing child restraint system on a rear seat:** adjust the front seat so that the seat does not touch the child restraint system.
- When using a category I forward-facing child restraint system:** remove the head restraint from the respective seat, if possible.

After the child restraint system has been removed, replace the head restraint immediately and adjust all head restraints correctly.

- The backrest of the forward-facing child restraint system must, as far as possible, be resting on the seat backrest of the rear seat.
- For certain child restraint systems in weight category II or III, there may be restrictions on the maximum size setting, e.g. due to possible contact with the roof.
- The child restraint system must not be put under strain between the roof and the seat cushion and/or be installed facing the wrong direction. Where possible, adjust the seat cushion inclination accordingly.
- The child restraint system must not be put under strain by the head restraint. Adjust the head restraints as appropriate.
- Make sure that the child's feet do not touch the front seat. If necessary, move the front seat slightly forwards.

The seat belts on the following seats are equipped with a child seat safety feature:

- Co-driver's seat
- Rear seats

When enabled, the child seat safety feature ensures that the seat belts of the co-driver's seat

and rear seats do not slacken once the child restraint system is secured (→ page 36).

- ▶ Install the child restraint system. The entire base of the child restraint system must always rest on the sitting surface of the rear seat.
- ▶ Always make sure that the shoulder belt strap is correctly routed from the seat belt outlet of the vehicle to the shoulder belt guide on the child restraint system. The shoulder belt strap must be routed forwards and downwards from the seat belt outlet.

Notes on rearward-facing and forward-facing child restraint systems on the co-driver seat

⚠ WARNING Risk of injury or death when using a child restraint system while the co-driver airbag is enabled

If you secure a child in a child restraint system on the co-driver seat and the PASSENGER AIR BAG OFF indicator lamp is off, the co-driver airbag can deploy in the event of an accident.

The child could be struck by the airbag.

- ▶ Always ensure that the co-driver airbag is disabled. The PASSENGER AIR BAG OFF indicator lamp must be lit.

NEVER use a rearward facing child restraint on a seat protected by an ENABLED AIRBAG in front of it, DEATH or SERIOUS INJURY to the CHILD may occur.

Observe the specific instructions for the rearward-facing and forward-facing child restraint systems (→ page 39).

Always observe the status of the co-driver airbag on the PASSENGER AIR BAG OFF indicator lamp:

- When using a rearward-facing child restraint system on the co-driver seat, the co-driver airbag must always be disabled. It is only deactivated if the PASSENGER AIR BAG OFF indicator lamp is lit continuously (→ page 31).
- If the PASSENGER AIR BAG OFF indicator lamp is off, the co-driver airbag is enabled. The co-driver airbag may deploy during an accident.

Securing the child restraint system with the seat belt on the co-driver seat

When installing a belt-secured child restraint system on the co-driver seat, always observe the following:

- ☑ Observe the notes on rearward-facing and forward-facing child restraint systems on the co-driver seat (→ page 39).
- ☑ Observe the child restraint system manufacturer's installation and operating instructions.
- ☑ When using a forward-facing child restraint system in category I: remove the head restraint from the respective seat, if possible.

After the child restraint system has been removed, replace the head restraint immediately and adjust all head restraints correctly.

- ☑ The backrest of the forward-facing child restraint system must, as far as possible, be resting on the seat backrest of the co-driver seat.
- ☑ For certain child restraint systems in weight category II or III, there may be restrictions on the maximum size setting, e.g. due to possible contact with the roof.
- ☑ The child restraint system must not be put under strain between the roof and the seat cushion and/or be installed facing the wrong direction.
- ☑ The child restraint system must not be put under strain by the head restraint. Adjust the head restraints as appropriate.
- ☑ Never place objects (e.g. cushions) under or behind the child restraint system.

The seat belt on the co-driver side is equipped with a special seat belt retractor.

When enabled, the special seat belt retractor ensures that the seat belt does not slacken once the child seat is secured (→ page 36).

- ▶ Set the co-driver seat as far back as possible and move the seat into the highest position possible.
- ▶ Set the seat backrest to the most vertical position possible.
- ▶ Install the child restraint system. The entire base of the child restraint system must always rest on the sitting surface of the co-driver seat.

- ▶ Always make sure that the shoulder belt strap is correctly routed from the seat belt outlet of the vehicle to the shoulder belt guide on the child restraint system.

The shoulder belt strap must be routed forwards and downwards from the seat belt outlet.

- ▶ If necessary, adjust the seat belt outlet and the co-driver seat as appropriate.

Child safety locks

Activating or deactivating child safety locks for the doors

- ▲ **WARNING** Risk of accident and injury due to children left unattended in the vehicle

If children are left unsupervised in the vehicle, they could, in particular:

- Open doors, thereby endangering other persons or road users.
- Get out and be struck by oncoming traffic.
- Operate vehicle equipment and become trapped, for example

In addition, the children could also set the vehicle in motion, for example by:

- Releasing the parking brake.
- Changing the transmission position.
- Starting the vehicle.

- ▶ Never leave children unattended in the vehicle.
- ▶ When leaving the vehicle, always take the SmartKey with you and lock the vehicle.
- ▶ Keep the vehicle SmartKey out of reach of children.

- ▲ **WARNING** Danger to life due to exposure to extreme heat or cold in the vehicle

If people, particularly children, are exposed to extreme temperatures over an extended period of time, there is a risk of serious injury or danger to life.

- ▶ Never leave persons, children in particular, unattended in the vehicle.

- ▲ **WARNING** Risk of accident and injury due to children left unattended in the vehicle

If children are traveling in the vehicle, they could, in particular:

- Open doors, thereby endangering other persons or road users
- Get out and be struck by oncoming traffic
- Operate vehicle equipment and become trapped, for example

- ▶ Always activate the child safety locks installed if children are traveling in the vehicle.
- ▶ Never leave children unattended in the vehicle.
- ▶ When leaving the vehicle, always take the SmartKey with you and lock the vehicle.

The following doors have child safety locks:

- Sliding doors
- Pop-out windows

The child safety locks on the doors secure each door separately. The doors can no longer be opened from the inside (exception: electric sliding door). When the vehicle is unlocked, the door can be opened from the outside.

If the electric sliding door is secured, only the sliding door controls in the rear compartment are deactivated. The electric sliding door can be opened at any time using the switch in the center console.

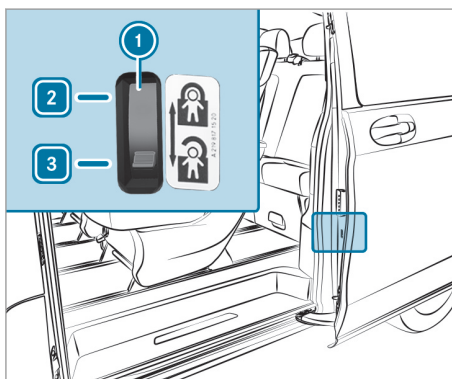

- ▶ Slide child safety lock bolt 1 to position 2 (activate) or 3 (deactivate).

- ▶ Make sure that the child safety locks are working properly.

Activating or deactivating child safety locks for the pop-out windows

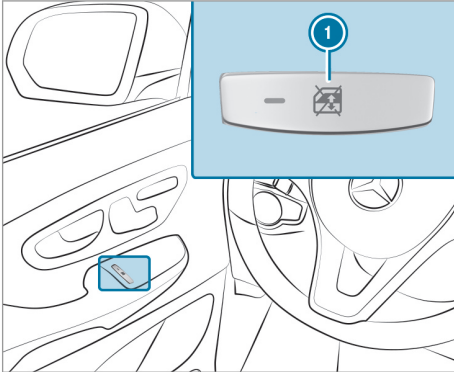

- ▶ **To activate and deactivate:** press button ①.
If the indicator lamp on button ① is lit, operation of the electrical pop-out windows is disabled. Operation is then only possible using the buttons in the driver's door.

Notes on pets in the vehicle

⚠ WARNING Risk of accident and injury due to animals left unsecured or unattended in the vehicle

If you leave animals in the vehicle unattended or unsecured, they could possibly press buttons or switches.

An animal may:

- Activate vehicle equipment and become trapped, for example
- Switch systems on or off and endanger other road users

Unsecured animals may be thrown around in the vehicle in the event of an accident or sudden steering and braking maneuvers and injure vehicle occupants in the process.

- ▶ Never leave animals in the vehicle unattended.
- ▶ Always correctly secure animals while driving, e.g. using a suitable animal carrier.

SmartKey

Overview of key functions

⚠ WARNING Risk of accident and injury due to children left unattended in the vehicle

If children are left unsupervised in the vehicle, they could, in particular:

- open doors, thereby endangering other persons or road users.
- get out and be struck by oncoming traffic.
- operate vehicle equipment and become trapped, for example.

In addition, the children could also set the vehicle in motion, for example by:

- releasing the parking brake.
- changing the transmission position.
- starting the vehicle.

- ▶ Never leave children unattended in the vehicle.
- ▶ When leaving the vehicle, always take the SmartKey with you and lock the vehicle.
- ▶ Keep the vehicle SmartKey out of reach of children.

⚠ WARNING Risk of accident due to the key inadvertently turning in the ignition lock

If you fasten heavy or large objects to the key, the key can inadvertently turn in the ignition lock while you are driving.

- ▶ Do not fasten any heavy or large objects to the key.
- ▶ Remove bulky key rings before you insert the key into the ignition lock.

! NOTE Damage to the SmartKey caused by magnetic fields

- ▶ Keep the SmartKey away from strong magnetic fields.

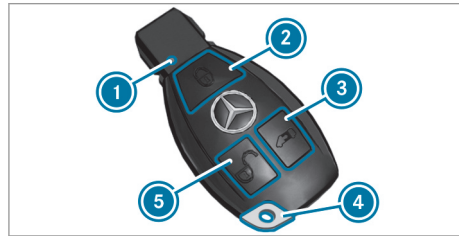



- ① Indicator lamp
- ② To lock the vehicle centrally
- ③ To unlock the sliding doors and the tailgate or rear-end door, or to unlock and open/close the electric sliding door
- ④ Emergency key
- ⑤ To unlock the vehicle centrally or the front door(s) only

The key's factory setting enables you to centrally lock and unlock the following components:

- the driver's door and co-driver door
 - the sliding doors
 - the tailgate or rear-end doors
- ⓘ If you do not open the vehicle within approximately 40 seconds of unlocking, the vehicle will lock again and anti-theft protection will be armed again.

Do not keep the key together with electronic devices or metallic objects. This can affect the key's functionality.



- ⓘ If the check lamp does not light up when you press the  or  button, the battery is discharged.

Replace the key battery (→ page 43).

Changing the unlocking settings

The key has the following adjustable unlocking functions:

- Unlock centrally
- Unlock the driver's and co-driver's door (panel van)
- Unlock the driver's door (Tourer)

▶ **To switch between the settings:** press and hold the  and  buttons at the same time for approximately six seconds until the indicator lamp flashes twice.

▶ **To unlock the vehicle centrally when the unlocking function is selected for the driv-**

er's door or the driver's and co-driver's door: press the  button a second time.

Removing and inserting the emergency key



i The anti-theft alarm system (ATA) is triggered when you unlock and open the vehicle using the emergency key (→ page 59).

- ▶ **To remove:** slide release catch **1** in the direction of the arrow and at the same time, remove emergency key **2** from the key completely.
- ▶ **To insert:** push emergency key **2** completely into the key until it engages and release catch **1** is back in its basic position.

Replacing the key battery

⚠ DANGER Serious damage to health caused by swallowing batteries

Batteries contain toxic and corrosive substances. Swallowing batteries may cause serious damage to health.

There is a risk of fatal injury.

- ▶ Keep batteries out of the reach of children.
- ▶ If batteries are swallowed, seek medical attention immediately.

🌿 ENVIRONMENTAL NOTE Environmental damage due to improper disposal of batteries



Batteries contain pollutants. It is illegal to dispose of them with the household rubbish.



Dispose of batteries in an environmentally responsible manner. Take discharged batteries to a qualified specialist workshop or to a collection point for used batteries.

Requirements:

- You require a CR 2025 3 V cell battery

Changing the battery

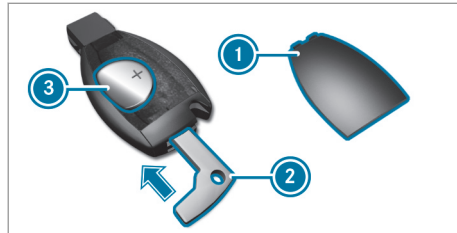

Mercedes-Benz recommends that you have the battery changed at a qualified specialist workshop.

- ▶ Remove the emergency key (→ page 43).



- ▶ Press emergency key **2** into the opening in the key in the direction of the arrow until battery compartment cover **1** opens. When doing so, do not hold battery compartment cover **1** shut.
- ▶ Tap the key against the palm of your hand so that battery **3** falls out of the battery compartment.
- ▶ Insert the new battery into the battery tray with the positive pole facing upwards. Use a lint-free cloth to do so.
- ▶ Install battery compartment cover **1** to the key casing with the front lugs first and push it closed.
- ▶ Slide emergency key **2** back into the key (→ page 43).

Problems with the key

Problem	Possible causes/consequences and ► Solutions
It is no longer possible to lock the vehicle using the key.	Possible causes: <ul style="list-style-type: none"> • The doors are not closed properly. ► Close the doors properly and lock the vehicle again.
The turn signal lamps do not flash when the vehicle is locked.	Possible causes: <ul style="list-style-type: none"> • The central locking system has malfunctioned. ► Lock the vehicle using the emergency key (→ page 43) or press down the safety pins and then close the doors. ► Have the locking system checked at a qualified specialist workshop.
It is no longer possible to lock or unlock the vehicle using the key.	Possible causes: <ul style="list-style-type: none"> • The key battery is weak or discharged. • The key is faulty. ► Point the tip of the key at the driver's door handle from very close range and press the  or  button. If this does not work: <ul style="list-style-type: none"> ► Replace the key battery (→ page 43). or <ul style="list-style-type: none"> ► Use the emergency key to unlock and lock the vehicle (→ page 43). ► Have the key checked at a qualified specialist workshop.
The engine cannot be started using the key.	Possible causes: <ul style="list-style-type: none"> • The on-board electrical system voltage is too low. ► Switch off all non-essential consumers, such as interior lighting, and try to start the engine again. If this does not work: <ul style="list-style-type: none"> ► Check the starter battery and charge it, if necessary (→ page 191). or <ul style="list-style-type: none"> ► Jump-start the vehicle (→ page 191). or <ul style="list-style-type: none"> ► Consult a qualified specialist workshop.
You have lost a key.	► Have the key deactivated at a qualified specialist workshop. ► If necessary, have the mechanical locks replaced.
You have lost the emergency key.	► Report the loss immediately to the vehicle insurers. ► If necessary, have the mechanical locks replaced.

Doors

Unlocking and opening the door from inside

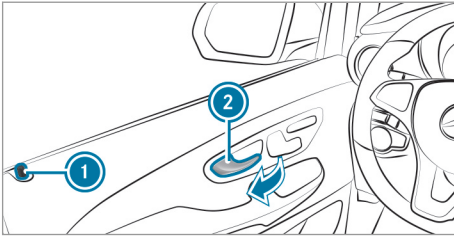

Door handle (example: driver's door)

- ▶ Pull door handle ②.
- Locking knob ① pops up when the door is unlocked.

Centrally locking and unlocking the door from the inside

⚠ WARNING Risk of accident and injury due to children left unattended in the vehicle

If children are left unsupervised in the vehicle, they could, in particular:

- open doors, thereby endangering other persons or road users.
- get out and be struck by oncoming traffic.
- operate vehicle equipment and become trapped, for example.

In addition, the children could also set the vehicle in motion, for example by:

- releasing the parking brake.
 - changing the transmission position.
 - starting the vehicle.
- ▶ Never leave children unattended in the vehicle.
 - ▶ When leaving the vehicle, always take the SmartKey with you and lock the vehicle.
 - ▶ Keep the vehicle SmartKey out of reach of children.

⚠ WARNING Danger to life due to exposure to extreme heat or cold in the vehicle

If people, particularly children, are exposed to extreme temperatures over an extended period of time, there is a risk of serious injury or danger to life.

- ▶ Never leave persons, children in particular, unattended in the vehicle.

You can use the central locking buttons to centrally lock and unlock the entire vehicle from the inside.

The central locking buttons are located in the driver's door.

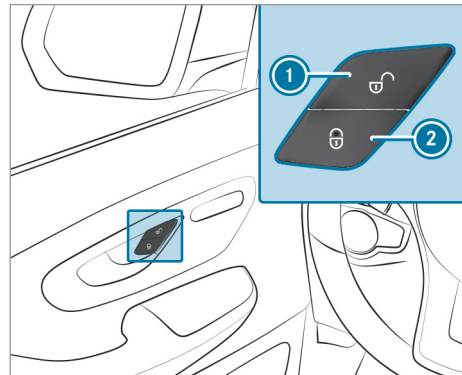

Central locking buttons (vehicles with manually adjustable front seats)

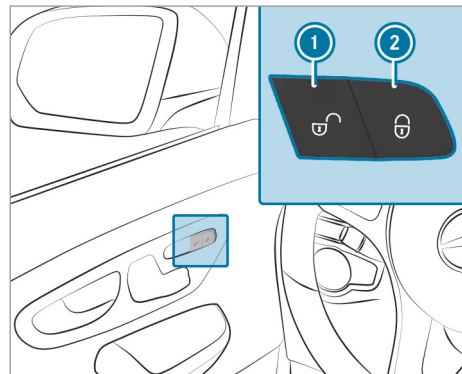

Central locking buttons (vehicles with electrically adjustable front seats)

- ▶ **To lock or unlock the entire vehicle:** press button ① (unlock) or ② (lock) when the doors are closed.

Observe the following settings when locking and unlocking from inside:

- If the driver's or co-driver's door is open, the open door is not locked.
All other doors and the tailgate/rear-end doors are locked.
- If a sliding door or the tailgate/rear-end doors are open, only the driver's and co-driver's doors are locked.
- You cannot unlock the vehicle centrally from the inside if the vehicle has been locked with the key.
- If the vehicle has been locked using the central locking button and a door is opened from the inside, only the door that has been opened is unlocked.
- If the vehicle has previously been locked with the key, opening a door from the inside will trigger the anti-theft alarm system. Switch off the alarm (→ page 60).

Activating/deactivating the automatic lock-up mechanism

Requirements:

- The power supply or the ignition is switched on.
- The doors are closed.

When the ignition is switched on and the vehicle is driving at a speed above 9 mph (15 km/h), the vehicle locks automatically.

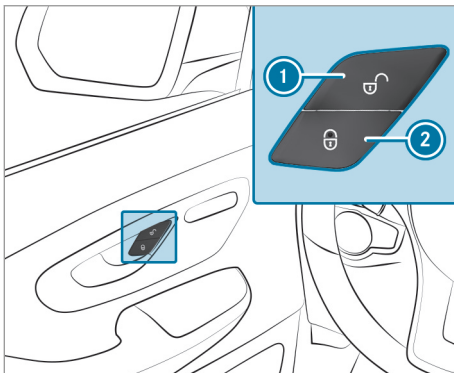

Central locking buttons (vehicles with manually adjustable front seats)

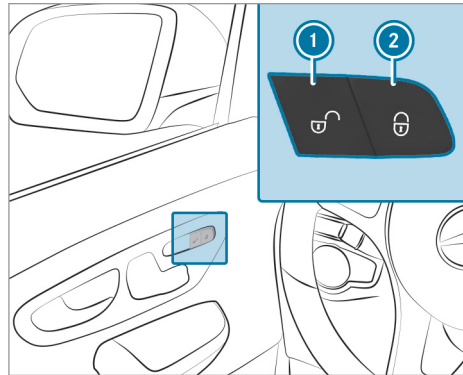

Central locking buttons (vehicles with electrically adjustable front seats)

- If the vehicle is on a roller dynamometer and is being towed or pushed, there is a risk of being locked out when the function is switched on.

▶ **To activate:** press and hold button ② for approximately five seconds.
An acoustic signal sounds.

▶ **To deactivate:** press and hold button ① for approximately five seconds.
An acoustic signal sounds.

Unlocking and locking the driver's door with the emergency key

① To lock the vehicle fully with the emergency key, press down the locking pins of the doors. Then lock the driver's door with the emergency key.

▶ **To unlock:** insert the emergency key fully into the driver's door lock and turn it counter-clockwise.

▶ **To lock:** insert the emergency key fully into the driver's door lock and turn it clockwise.

① **Right-hand drive vehicles:** turn the emergency key in the opposite direction for each case.

Sliding door

Opening/closing the sliding door from outside

⚠ WARNING Risk of becoming trapped due to an open sliding door which is not engaged in place

On an incline, the sliding door can move by itself.

This can cause you or other people to become trapped.

▶ Always make sure that the open sliding door is engaged. To do so, open the sliding door to the stop.

! NOTE Damage to the sliding door due to incorrect use

Using the lower guide of the sliding door (carriage) as a step can result in damage to the trim and/or mechanical components of the sliding door.

▶ Do not use the lower guide of the sliding door (carriage) as a step.

Opening

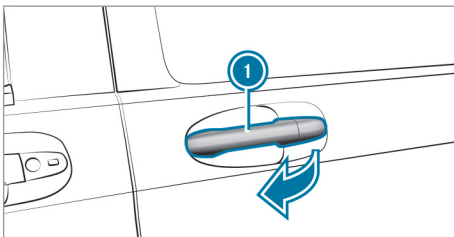

The sliding door is equipped with an active retainer, which engages when the door is opened as far as it will go.

- ▶ Pull door handle ① in the direction of the arrow. The sliding door opens.
- ▶ Push back the sliding door using door handle ① until it engages.
- ▶ Check the sliding door catch.

Closing

- ▶ Pull the sliding door by door handle ①. The sliding door is released from its catch.
- ▶ Push the sliding door firmly forwards using door handle ① and close it.

Opening/closing the sliding door from inside

⚠ WARNING Risk of becoming trapped due to sliding door opening towards the rear

When you open the sliding door, the sliding door could hit other people as it moves towards the rear of the vehicle.

▶ Only open the sliding door when traffic conditions permit.

Opening

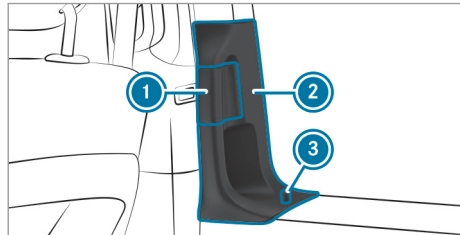

- ▶ Pull back rocker switch ①. If the door is locked, locking pin ③ pops up. The sliding door unlocks and opens.
- ▶ Push back the sliding door using door handle ② until it engages.
- ▶ Check the sliding door catch.

Closing

- ▶ Push rocker switch ① forwards. The sliding door is released from its catch.
- ▶ Push the sliding door forwards using door handle ② and close it.

Electric sliding door

Function of the electric sliding door

⚠ WARNING Risk of becoming trapped despite reversing function

The reversing feature does not react:

- to soft, light and thin objects, e.g. fingers
- over the last $\frac{1}{3}$ in (8 mm) of the closing movement

The reversing feature therefore cannot prevent someone being trapped in these situations.

▶ Make sure that no body parts are in the closing area.

If someone becomes trapped, take the following actions:

- press the  button on the key or
- pull the exterior door handle or
- press the appropriate sliding door button in the center console or
- press the button on the door sill or
- pull the rocker switch on the door handle

⚠ WARNING Risk of becoming trapped due to sliding door opening towards the rear

When you open the sliding door, the sliding door could hit other people as it moves towards the rear of the vehicle.

- ▶ Only open the sliding door when traffic conditions permit.

! NOTE Damage to the sliding door due to incorrect use

Using the lower guide of the sliding door (carriage) as a step can result in damage to the trim and/or mechanical components of the sliding door.

- ▶ Do not use the lower guide of the sliding door (carriage) as a step.

You must reset the electric sliding door if there has been a malfunction or a drop in voltage (→ page 50).

- ⓘ Please note that the sliding door cannot be opened from the inside when the child-proof lock is activated. You can only open the sliding door from the inside if the child safety locks have not been activated. Further information on this can be found in the "Occupant safety" (→ page 40) and "Opening and closing" (→ page 48) sections.

Your vehicle can be equipped with an electric sliding door on the left and/or right-hand side.

You can open and close the sliding door with these controls:

- Sliding door buttons on the center console
- Sliding door button on the door sill (B-pillar)
- Door handle (inside or outside)
- Key

The sliding door is equipped with automatic blockage detection with reversing function. If a solid object blocks or restricts the sliding door

during the automatic closing process, the sliding door opens again automatically. If the sliding door is obstructed during the opening procedure, it moves back a few centimeters in the opposite direction and stops.

The automatic blockage detection with reversing function is only an aid. It is not a substitute for your attentiveness when closing the electrical sliding door.

If an obstacle is detected, the display shows the [Left-hand Electric Sliding Door Obstruction Detected](#) message, for example, and five warning tones sound.

- ⓘ In unfavorable operating conditions, e.g. frost, ice or heavy soiling, press and hold the appropriate sliding door button. The electric sliding door moves with increased force. Observe that in such circumstances, the blockage detection is less sensitive. To stop the movement, release the sliding door button.

Opening and closing the electrical sliding door from the inside

⚠ WARNING Risk of becoming trapped due to sliding door opening towards the rear

When you open the sliding door, the sliding door could hit other people as it moves towards the rear of the vehicle.

- ▶ Only open the sliding door when traffic conditions permit.

Opening

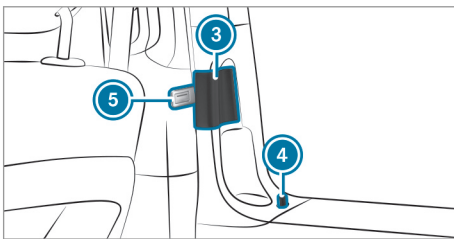
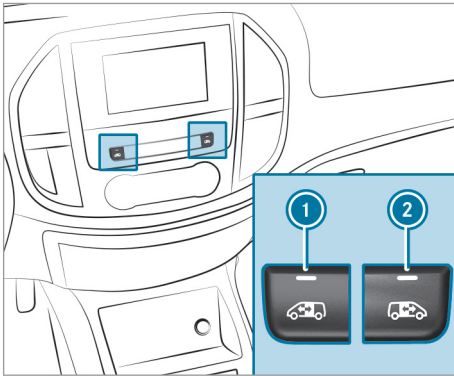

- ❶ Sliding door button for the sliding door on the left-hand side
- ❷ Sliding door button for the sliding door on the right-hand side
- ❸ Rocker switch
- ❹ Locking knob
- ❺ Sliding door button in the door sill

You can only open a sliding door with sliding door button ❺ in the door sill or with rocker switch ❸ on the door handle if the child-proof lock has not been activated.

The sliding door is equipped with an active retainer, which engages the door at the end stop when opened.

- ▶ Briefly press appropriate sliding door button ❶ or ❷ in the center console.
- or
- ▶ Press sliding door button ❺ in the door sill.
- or
- ▶ Briefly pull back rocker switch ❸.
If the door is locked, locking knob ❹ pops up. The sliding door unlocks, automatic operation is started and the sliding door opens.

If you use sliding door button ❶ or ❷ in the center console you will hear two warning signals during the opening procedure.

The indicator lamp in sliding door button ❶ or ❷ in the center console flashes for the duration of automatic operation.

The indicator lamp in sliding door button ❶ or ❷ in the center console is lit whenever the appropriate sliding door is open. Depending on the vehicle equipment, the display can also show the **Sliding Door Open** message.

Closing

- ▶ Briefly press appropriate sliding door button ❶ or ❷ in the center console.

or

- ▶ Press sliding door button ❺ in the door sill.

or

- ▶ Briefly push rocker switch ❸ forwards.
The sliding door is released from its lock and automatic operation is started. The sliding door closes.

If you use sliding door button ❶ or ❷ in the center console you will hear two warning signals during the closing procedure.

The indicator lamp in sliding door button ❶ or ❷ in the center console goes out whenever the corresponding sliding door is closed.

Interrupting automatic operation

- ▶ Press corresponding sliding door button ❶ or ❷ in the center console again.

or

- ▶ Press sliding door button ❺ in the door sill again.

or

- ▶ Briefly pull back rocker switch ❸.

Opening/closing the electric sliding door with the key

- ❶ If the vehicle is equipped with two sliding doors, the  button on the key can only be used to open or close one of the two sliding doors (→ page 50).

- ▶ **To unlock:** briefly press the  button on the key.

- ▶ **To open:** press and hold the  button on the key for longer than 0.5 seconds. You will hear two acoustic signals and the sliding door will open automatically.

▶ **To close:** press and hold the  button on the key for longer than 0.5 seconds. You will hear two acoustic signals and the sliding door will close automatically.

▶ **To interrupt automatic operation:** briefly press the  button on the key. The sliding door stops moving.

❶ In unfavorable operating conditions, e.g. frost, ice or heavy soiling, press and hold the appropriate sliding door button. The electric sliding door moves with increased force. Observe that, in such circumstances, the obstacle detection is less sensitive. To stop the movement, release the sliding door button.

Opening/closing the electrical sliding door from the outside

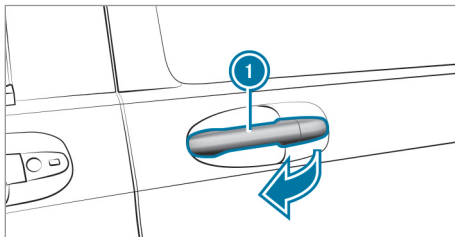

▶ **To open:** pull door handle ❶. The sliding door unlocks, automatic operation is started and the sliding door opens. In addition, you will hear two warning signals.



▶ **To close:** pull door handle ❶. The sliding door is released from its lock and automatic operation is started. The sliding door closes.

▶ **To interrupt automatic operation:** pull door handle ❶ again.

Programming the key button for the sliding door

Requirements

- The vehicle is equipped with two electric sliding doors.
- The sliding door to be programmed is open.
- The ignition is switched on.

The  button on the key can be programmed. Program the  button to open the right or left sliding door.

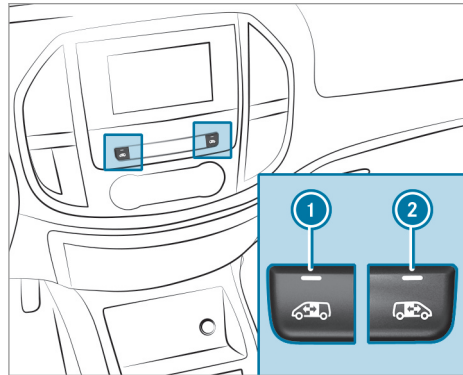

❶ Sliding door button for the sliding door on the left-hand side

❷ Sliding door button for the sliding door on the right-hand side



▶ Press and hold sliding door button ❶ or ❷ in the center console for the appropriate sliding door until the sliding door is closed and four tones have sounded.



The **Left-hand Electric Sliding Door Key Programmed/Right-hand Electric Sliding Door Key Programmed** message appears in the display.

Resetting the electric sliding door

You must reset the electric sliding door if there has been a malfunction or a drop in voltage.

▶ If the sliding door is open: close it by hand.

▶ Using the corresponding  or  sliding door button on the center console, open the sliding door at least 15.8 in (40 cm) and then close the sliding door completely.

▶ When the sliding door is closed, open the sliding door fully using the corresponding  or  sliding door button on the center console.

The sliding door is reset and operational.

Problems with the electric sliding door

Problem	Possible causes/consequences and ► Solutions
The electric sliding door is locked in place.	<p>Unfavorable operating conditions, e.g. frost, ice or heavy soiling, may obstruct the sliding door.</p> <ul style="list-style-type: none"> ► Press and hold the sliding door button until the sliding door has opened or closed. The sliding door moves with increased force. Observe that in such circumstances, the blockage detection is less sensitive. To stop the movement, release the sliding door button. ► Remove the cause of the blockage at the earliest opportunity.

Tailgate

Opening and closing the tailgate

⚠ DANGER Risk of exhaust gas poisoning

Combustion engines emit poisonous exhaust gases such as carbon monoxide. Exhaust gases can enter the vehicle interior if the tailgate is open when the engine is running, especially if the vehicle is in motion.

- Always switch off the engine before opening the tailgate.
- Never drive with the tailgate open.

! **NOTE** Damage to the tailgate caused by obstacles above the vehicle

The tailgate swings rearwards and upwards when it is opened.

- Make sure that there is sufficient space behind and above the tailgate.

i You will find details of the tailgate opening dimensions under "Technical data" (→ page 232).

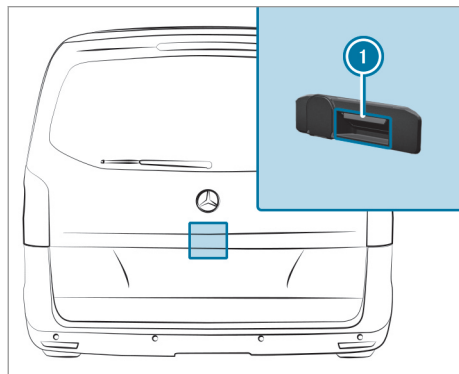

- **To open:** push button ① on the handle and raise the tailgate.

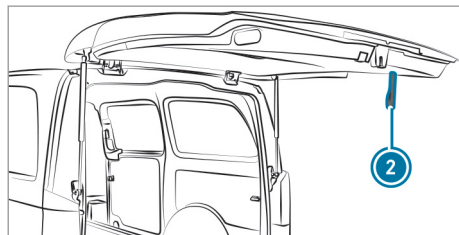

- **To close:** pull the tailgate firmly downwards by loop ② and close it from outside.

Opening the tailgate in an emergency

If the battery voltage is low or the voltage supply is interrupted, the tailgate cannot be opened.

In an emergency, you can open the tailgate using the release catch for service purposes.

- Pry off the cover on the lower part of the tailgate with a suitable tool, e.g. the screwdriver from the vehicle tool kit.

- ▶ Insert the screwdriver into the opening and move the release lever until the tailgate unlocks and opens.
- ▶ Lift the tailgate upwards.

EASY-PACK tailgate

Notes on the EASY-PACK tailgate

⚠ DANGER Risk of exhaust gas poisoning

Combustion engines emit poisonous exhaust gases such as carbon monoxide. Exhaust gases can enter the vehicle interior if the tailgate is open when the engine is running, especially if the vehicle is in motion.

- ▶ Always switch off the engine before opening the tailgate.
- ▶ Never drive with the tailgate open.

! NOTE Damage to the tailgate caused by obstacles above the vehicle

The tailgate swings rearwards and upwards when it is opened.

- ▶ Make sure that there is sufficient space behind and above the tailgate.

- ① You will find details of the tailgate opening dimensions under "Technical data" (→ page 232).

Obstruction detection with reversing function

The tailgate is equipped with automatic object detection with reversing function. If a solid object blocks or restricts the tailgate during the automatic closing process, the tailgate opens again automatically. The automatic object detection with reversing function is only an aid. It is not a substitute for your attentiveness when closing the tailgate.

⚠ WARNING Risk of becoming trapped despite reversing function

The reversing feature does not react:

- to soft, light and thin objects, e.g. fingers
- over the last $\frac{1}{3}$ in (8 mm) of the closing movement

The reversing feature therefore cannot prevent someone being trapped in these situations.

- ▶ Make sure that no body parts are in the closing area.

If someone is trapped:

- press the  button on the key or
- press the closing button on the tailgate or
- pull the handle of the tailgate

Opening and closing the EASY-PACK tailgate

Requirements:

- The rear window is closed.
- The tailgate is unlocked.
- There are no persons within the swinging range of the tailgate.
- **Vehicles with rear window which can be opened separately:** the  button of the key must be programmed to open and close the tailgate (→ page 54).

Opening

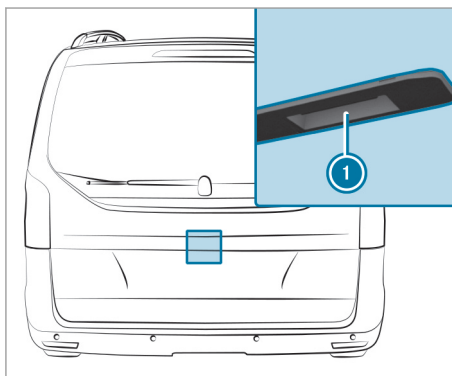

- ▶ Press button  in the handle and step out of the swinging range of the tailgate.

or

- ▶ Press the  button of the key for longer than 0.5 seconds. Automatic operation is started. The tailgate opens and swings upwards.

In addition, you will hear two warning signals.

Closing

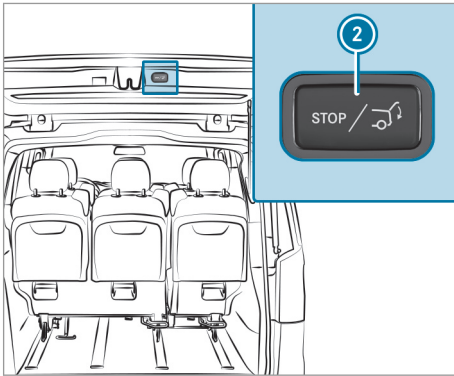

- ▶ Press button ② in the tailgate and step out of the swinging range of the tailgate.

or

- ▶ Press the button of the key for longer than 0.5 seconds. Automatic operation is started and the tailgate closes. During closing, closing button ② flashes and two warning tones sound.

Interrupting automatic operation

- ▶ Press button ① in the handle again.
- or
- ▶ Press closing button ② in the tailgate again.
- or
- ▶ Press the button on the key again for longer than 0.5 seconds.

Adjusting the opening angle of the tailgate

Setting the end position

You can set the opening angle of the tailgate by saving the desired position as the end position.

- ▶ Open the tailgate and stop automatic operation in the desired position.
- or
- ▶ Open the tailgate and manually swing it into the desired position.
 - ▶ Press and hold the closing button on the tailgate until the confirmation tone sounds once. The current position of the tailgate has been saved as the end position.

Resetting to the maximum opening angle

- ▶ Open the tailgate.
- ▶ Press and hold the closing button on the tailgate until the confirmation tone sounds twice. The saved end position has been deleted and the tailgate opens again to the maximum extent.

Resetting the tailgate

You must reset the tailgate if there has been a malfunction or an interruption in the voltage supply.

- ▶ If the tailgate is open: close the tailgate by hand.
 - ▶ Briefly press the button in the handle of the tailgate, step out of the swinging range of the tailgate and open the tailgate.
 - ▶ When the tailgate is fully open, press the closing button in the tailgate and step out of the swinging range of the tailgate. The tailgate closes. When the tailgate is fully closed, it is reset and operational.
- ⓘ When the button of the key is program for operating the tailgate (→ page 54), you can also use the key to open and close the tailgate.

Opening and closing the rear window

⚠ DANGER Risk of poisoning from exhaust gases

Combustion engines emit poisonous exhaust gases, such as carbon monoxide. Exhaust gases can enter the vehicle interior if the rear window is open when the engine is running, especially if the vehicle is in motion.

- ▶ Always switch off the engine before opening the rear window.
- ▶ Never drive with the rear window open.

Requirements:

- The vehicle or cargo compartment is unlocked and the tailgate is closed.
- The button on the key is programmed to open the rear window (→ page 54).

Opening

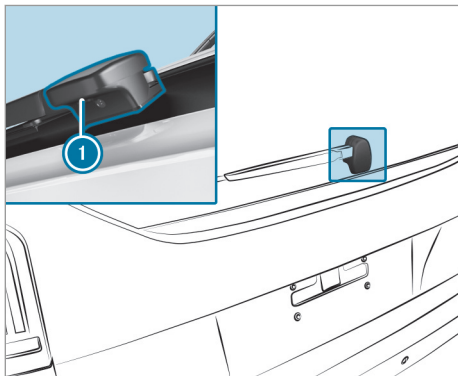

▶ Press the  button on the key.
or

▶ Press button ① on the handle on the rear window.

Closing

▶ Swing the rear window down and push it closed.

Programming the key button for the tailgate or rear window

Requirements:

- The tailgate and the rear window are closed.
- The ignition is switched on.

If your vehicle is equipped with an EASY-PACK tailgate, you can program the  button on the key either to open/close the tailgate or to open the rear window.

- ▶ Press the buttons in the handle of the tailgate and in the handle of the rear window simultaneously for approximately five seconds. After successfully changing the function, the vehicle turn signal lamps flash once.
- ▶ Check the function of the  button on the key.

Rear-end doors

Opening and closing the rear-end doors from outside

⚠ DANGER Risk of poisoning from exhaust gases

Combustion engines emit poisonous exhaust gases, such as carbon monoxide. Exhaust gases can enter the vehicle interior if the tailgate or the rear-end door is open when the engine is running, especially if the vehicle is in motion.

- ▶ Always switch off the engine before opening the tailgate or the rear-end door.
- ▶ Never drive the vehicle when the tailgate or rear-end door is open.

⚠ WARNING Risk of injury due to the rear-end door swinging open

When you open a rear-end door, the following can occur:

- You or another person can be injured.
- A person may be struck by oncoming traffic.

This is particularly the case if you open the rear-end door more than 90° or if it opens in an uncontrolled manner.

Even rear-end doors which are properly closed can swing open when the vehicle parked is on an incline or it is windy.

- ▶ Only open a rear-end door when the traffic conditions and surroundings permit.
- ▶ Always make sure that the rear-end doors are properly closed.

⚠ WARNING Risk of accident due to concealed lighting systems

If you open the rear-end doors by 90°, the rear lighting installations will be concealed.

Other road users will then not be able to see the vehicle, or will see it only with difficulty.

Therefore, in these or similar situations, safeguard the vehicle in accordance with national regulations, e.g. with a warning triangle.

NOTE Damage to the rear-end doors due to objects obstructing their range of movement

When the rear-end doors are opened, any objects obstructing the range of movement of the rear-end doors can be damaged as well as the vehicle.

▶ Make sure that there is sufficient clearance when opening the rear-end doors.

Opening the right rear-end door

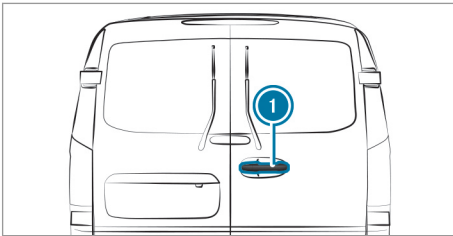

You can stop the rear-end doors at an angle of approximately 90°, and also at 180° or 270°. Make sure that the opened rear-end door is stopped correctly in the catch.

- ▶ Pull handle ①.
- ▶ Swing the rear-end door to the side until it engages.

i The rear-end doors can also be opened beyond 90° (→ page 56).

Opening the left rear-end door

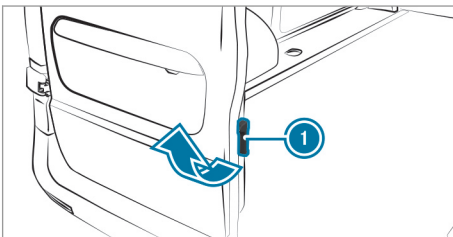

- ▶ Make sure that the right rear-end door is open and engaged.
- ▶ Pull release handle ① in the direction of the arrow.
- ▶ Swing the rear-end door to the side until it engages.

Closing the rear-end doors from outside

- ▶ If necessary, pull the rear-end doors away from the magnetic door retainer (→ page 56).
- ▶ Close the left rear-end door firmly from outside.
- ▶ Close the right rear-end door firmly from outside.

Opening/closing the rear-end doors from the inside

Opening

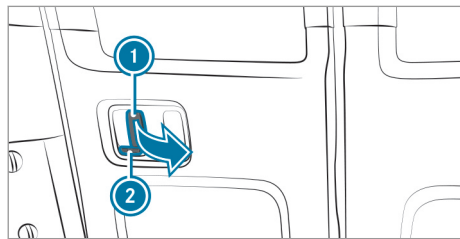

A white area on latch ② indicates that the rear-end door is unlocked.

- ▶ **To unlock:** slide latch ② to the left. A white area is visible.
- ▶ Pull release lever ① and open the rear-end door.
- ▶ Swing the rear-end door to the side until it engages.

i If you open a locked rear-end door from inside, you only unlock the rear-end door. The other doors remain locked.

Closing

- ▶ Make sure that the left rear-end door is closed.
- ▶ Pull the right rear-end door firmly to by the door handle.
- ▶ **To lock:** slide latch ② to the right. The white area is no longer visible.

Opening the rear-end doors 180° or 270°

! **NOTE** Damage due to collision between the rear-end door and the sliding door or the pop-out window

If the respective rear-end door is opened 270° while the sliding door is open, the doors will collide.

There will be a collision between the rear window wiper and the pop-out window under the following circumstances:

- The pop-out window is open.
 - The rear-end door is open 270°.
 - The rear window wiper is in operation.
- ▶ Make sure that the sliding door is closed before opening the rear-end door to 270°.
 - ▶ Make sure that the rear window wiper is switched off or the pop-out window is closed before opening the rear-end door to 270°.

Requirements:

- The vehicle is designed such that you can open the rear-end doors 180° or 270° (side wall).

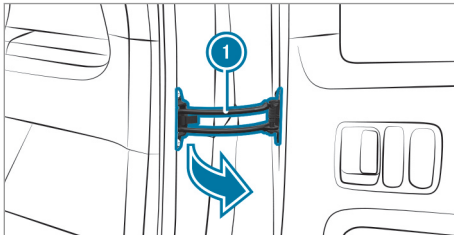

- ▶ Open the rear-end door approximately 45°.
- ▶ Pull and hold door retainer ① in the direction of the arrow.
- ▶ Open the rear-end door at an angle greater than 90° so that the door retainer is no longer locked in place.
- ▶ Release the door retainer and open the rear-end door 180° or 270°.

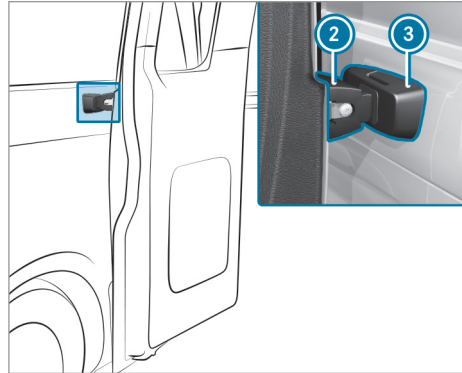

- ▶ With the rear-end door opened 270°, push it against magnetic door retainer ③ on the side wall.
- ▶ When the magnet on rear-end door ② is in contact with magnetic door retainer ③, the rear-end door is held in position.

Side window

Opening and closing the side windows

! **WARNING** Risk of entrapment when opening a side window

When opening a side window, parts of the body could be drawn in or become trapped between the side window and window frame.

- ▶ When opening, make sure that nobody is touching the side window.
- ▶ If someone is trapped, release the button immediately or pull it in order to close the side window again.

! **WARNING** Risk of becoming trapped when closing a side window

When closing a side window, body parts could be trapped in the closing area in the process.

- ▶ When closing, make sure that no body parts are in the closing area.
- ▶ If someone is trapped, release the button immediately or press the button in order to reopen the side window.

⚠ WARNING Risk of becoming trapped when children operate the side windows

Children could become trapped if they operate the side windows, particularly when unattended.

- ▶ Activate the child safety lock for the rear passenger compartment side windows.
- ▶ When leaving the vehicle, always take the SmartKey with you and lock the vehicle.
- ▶ Never leave children unattended in the vehicle.

⚠ WARNING Danger to life due to exposure to extreme heat or cold in the vehicle

If people, particularly children, are exposed to extreme temperatures over an extended period of time, there is a risk of serious injury or danger to life.

- ▶ Never leave persons, children in particular, unattended in the vehicle.

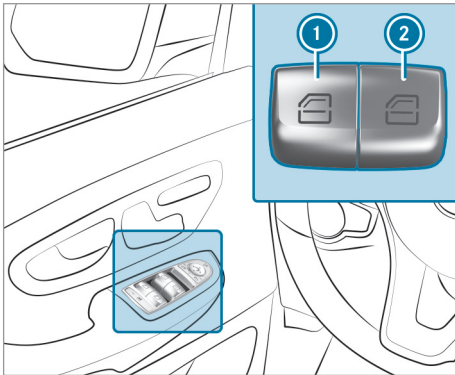

- ▶ **To open manually:** press and hold button ① or ②.

- ▶ **To close manually:** pull and hold button ① or ②.

The windows in the front doors can also be operated automatically.

- ▶ **To open completely:** briefly press button ① or ② beyond the point of resistance. Automatic operation will start.

- ▶ **To close completely:** briefly pull button ① or ② beyond the point of resistance. Automatic operation will start.

- ▶ **To interrupt automatic operation:** briefly press or pull button ① or ② again.

You can still operate the side windows when the vehicle is parked. The function will remain available for around five minutes or until a front door is opened.

Automatic reversing function of the side windows

If an object blocks a side window during the closing process, the side window will open again automatically. The automatic reversing function is only an aid and is not a substitute for your attentiveness.

- ▶ During the closing process, make sure that no body parts are in the closing area.

⚠ WARNING Risk of becoming trapped despite there being reversing protection on the side window

The reversing function does not react:

- To soft, light and thin objects, e.g. fingers.
- During resetting.

The reversing function cannot prevent someone from becoming trapped in these situations.

- ▶ During the closing process, make sure that no body parts are in the closing area.
- ▶ If someone becomes trapped, press the  button to open the side window again.

Ventilating the vehicle before starting a journey (convenience opening)

⚠ WARNING Risk of entrapment when opening a side window

When opening a side window, parts of the body could be drawn in or become trapped between the side window and window frame.

- ▶ When opening, make sure that nobody is touching the side window.
- ▶ Release the button immediately if somebody becomes trapped.

The "convenience opening" function can only be operated using the key. The key must be in close proximity to the driver's or co-driver door.

- ▶ Press and hold the  button on the key.

The following functions are performed:

 - The vehicle is unlocked
 - The side windows are opened
- ▶ **To interrupt convenience opening:** release the  button.

Closing the side windows from the outside (convenience closing)

⚠ WARNING Risk of entrapment due to not paying attention during convenience closing

When the convenience closing feature is operating, parts of the body could become trapped in the closing area of the side windows.

- ▶ When the convenience closing feature is operating, monitor the entire closing process and make sure that no body parts are in the closing area.

- ▶ Press and hold the  button on the key.

The following functions are performed:

 - the vehicle is locked
 - the side windows are closed
- ▶ **To interrupt convenience closing:** release the  button.



Adjusting the side windows

The side windows must be readjusted after a malfunction or a voltage supply interruption.

- ▶ Switch on the power supply (→ page 97).
- ▶ Push both buttons on the power window and hold for approximately one second after the side window has closed.
- ▶ If the side windows remain closed when you release the buttons, they have been reset correctly. If this is not the case, repeat the steps described for the open side windows.

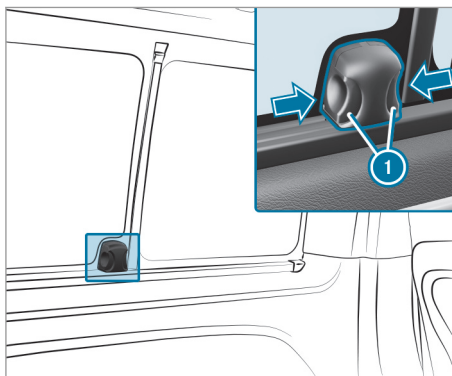
Opening and closing the sliding windows



- ▶ **To open:** press both handle sections  together simultaneously and slide the sliding window to the desired notch.
- ▶ **To close:** slide the sliding window shut until the handle sections  engage audibly and lie flat.

Problems with the side windows

Problem	Possible causes/consequences and ► Solutions
<p>You cannot open or close a side window all the way.</p>	<p>▲ WARNING Risk of becoming trapped or fatally injured if reversing protection is not activated</p> <p>If you close a side window again immediately after it has been blocked, the side window will close with increased or maximum force. The reversing function is then not active and body parts may become trapped.</p> <ul style="list-style-type: none"> ► Make sure that no parts of the body are in the closing area. ► To stop the closing process, release the button or press the button again to reopen the side window. <p>If there are no objects or leaves in the window guide preventing the window from closing, there may have been a malfunction or an interruption to the on-board electrical system voltage.</p> <p>► Reset the side windows (→ page 58).</p>

Anti-theft prevention

Function of the immobilizer

The immobilizer prevents your vehicle from being started without the correct key.

The immobilizer is automatically activated when the ignition is switched off, and deactivated when the ignition is switched on.

When leaving the vehicle, always take the key with you and lock the vehicle. If the key is left inside the vehicle, anyone can start the engine.

ATA (Anti-Theft Alarm system)

Function of ATA (Anti-theft Alarm system)

If the ATA system is armed, a visual and audible alarm is triggered in the following situations:

- When opening a door
- when opening the vehicle with the emergency key
- When opening the hood
- When opening the tailgate or rear-end door

After locking the vehicle with the key, the ATA system is automatically armed.

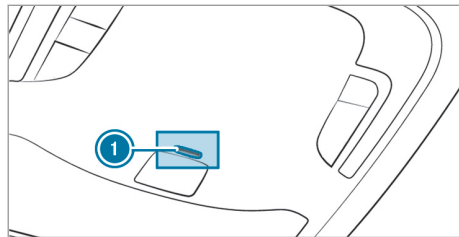

When the ATA system is armed, indicator lamp ① flashes in the overhead control panel.

ATA is automatically deactivated in the following situations:

- After unlocking the vehicle with the key.
 - When the key is inserted into the ignition lock.
- ① The alarm is not deactivated, even if you immediately close the open door that has triggered it, for example.

Arming/disarming ATA (Anti-theft Alarm system)

Arming

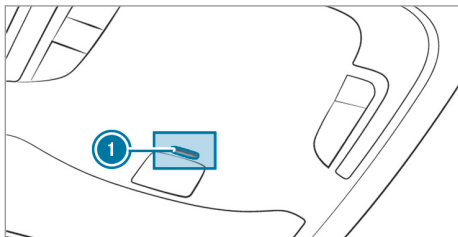



- ▶ Close all the doors.
- ▶ Lock the vehicle with the key. Indicator lamp ① in the overhead control panel flashes.

Disarming

- ▶ Unlock the vehicle with the key.
- or
- ▶ Insert the key into the ignition lock. Indicator lamp ① in the overhead control panel goes out.

Stopping the alarm

- ▶ Press the  or  button on the key.
- or
- ▶ Insert the key into the ignition lock. The alarm stops.

Function of the tow-away alarm

A visual and audible alarm is triggered if the inclination of the vehicle changes when tow-away alarm is armed. This can occur if the vehicle is raised on one side, for example.

Arming and disarming the tow-away alarm

Requirements:

- The doors are closed.
- The tailgate or rear-end doors are closed.

Arming

- ▶ Lock the vehicle with the key. The tow-away alarm is automatically armed after about 50 seconds.

Disarming

- ▶ Open the vehicle with the key.
- or

- ▶ Insert the key into the ignition lock. The tow-away alarm is disarmed.

Deactivating

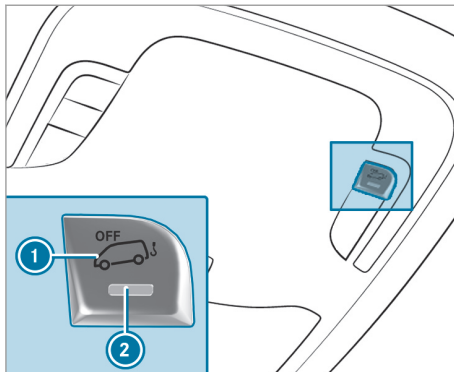

- ▶ Remove the key from the ignition lock.
- ▶ Press button ①. When the button is released, indicator lamp ② in the button lights up for approximately three seconds.
- ▶ Lock the vehicle with the key. The tow-away alarm is deactivated.

The tow-away alarm remains deactivated until you lock the vehicle again.

In the following situations, a false alarm can occur:

- When loading and/or transporting the vehicle on a ferry or car transporter, for example
- When parking the vehicle on a movable surface, such as a split-level garage

Deactivate the tow-away alarm in these situations.

Function of the interior motion sensor

Function

If the activated interior motion sensor detects motion in the vehicle interior, a visual and acoustic alarm is triggered. This can happen if someone reaches into the vehicle interior, for example.

Activating and deactivating the interior motion sensor

Requirements:

- The side windows are closed.
- The doors are closed.
- The tailgate or rear-end doors are closed.

Activating

- ▶ Make sure that nothing (such as mascots or coat hangers) is hanging on the inside rear-view mirror or on the grab handles. This will prevent false alarms.
- ▶ Lock the vehicle with the key.
The interior motion sensor is armed after approximately 20 seconds.

Deactivating

- ▶ Unlock the vehicle with the key.
- or
- ▶ Insert the key into the ignition lock.
The interior motion sensor automatically switches off.

Deactivating

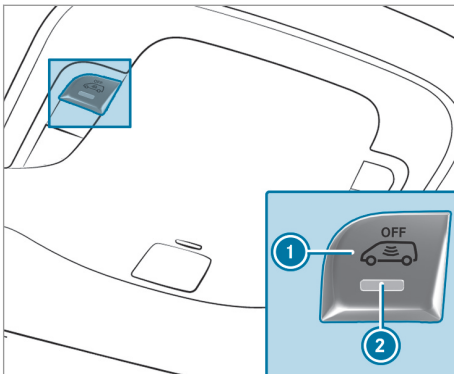

- ▶ Remove the key from the ignition lock.
- ▶ Press button ①.
When the button is released, indicator lamp ② in the button lights up for approximately three seconds.
- ▶ Lock the vehicle with the key.
The interior motion sensor is deactivated.

The interior motion sensor remains deactivated until you lock the vehicle again.

In the following situations, a false alarm can occur:

- If there are people or animals remaining inside
- When transporting the vehicle on a ferry or car transporter, for example

Deactivate the interior motion sensor in these situations.

Correct driver's seat position

⚠ WARNING Risk of accident due to adjusting the vehicle settings while the vehicle is in motion

You could lose control of the vehicle in the following situations in particular:

- If you adjust the driver's seat, the head restraint, the steering wheel or the mirror while the vehicle is in motion
- If you fasten your seat belt while the vehicle is in motion

▶ Before starting the engine: In particular, adjust the driver's seat, head restraint, steering wheel and mirror, and fasten your seat belt.

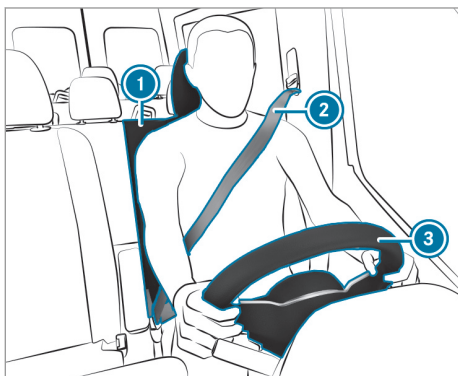

Ensure the following when adjusting steering wheel ③, seat belt ② and driver's seat ①:

- You are sitting as far away from the driver's airbag as possible.
- You are sitting in an upright position.
- Your thighs are slightly supported by the seat cushion.
- Your legs are not fully extended and you can easily depress the pedals all the way.
- The back of your head is supported at eye level by the middle part of the head restraint.
- You can reach the steering wheel with your arms in a slightly bent position.
- You can move your legs freely.
- You can see all the displays on the instrument cluster clearly.

- You have a good overview of the traffic conditions.
- Your seat belt sits snugly against your body and passes across the center of your shoulder and across your hips in the pelvic area.

Seats

Adjusting the front seat mechanically

⚠ WARNING Risk of becoming trapped if the seats are adjusted by children

Children could become trapped if they adjust the seats, particularly when unattended.

- ▶ When leaving the vehicle, always take the SmartKey with you and lock the vehicle.
- ▶ Never leave children unattended in the vehicle.

⚠ WARNING Risk of accident due to adjusting the vehicle settings while the vehicle is in motion

You could lose control of the vehicle in the following situations in particular:

- If you adjust the driver's seat, the head restraint, the steering wheel or the mirror while the vehicle is in motion
- If you fasten your seat belt while the vehicle is in motion

▶ Before starting the engine: In particular, adjust the driver's seat, head restraint, steering wheel and mirror, and fasten your seat belt.

⚠ WARNING Risk of becoming trapped when adjusting the seat

When you adjust a seat, you or other vehicle occupants could become trapped, e.g. on the seat guide rail.

- ▶ When adjusting a seat, make sure that no one has any part of their body within the sweep of the seat.

⚠ WARNING Risk of accident due to the driver's seat not being engaged

The driver's seat may move unexpectedly while driving.

This could cause you to lose control of the vehicle.

- ▶ Always make sure that the driver's seat is engaged before starting the vehicle.

⚠ WARNING Risk of injury or death due to the front seat being positioned too close to the cockpit

The front airbags can also injure the occupants in the front of the vehicle.

- ▶ Always adjust the front seats so they are as far away as possible from the front airbags.
- ▶ In addition, observe the notes on correct seat adjustment.

⚠ WARNING Risk of injury or death due to an incorrect seat position

The seat belt does not offer the intended level of protection if you have not moved the seat backrest to an almost vertical position.

In particular, you could slip beneath the seat-belt and become injured.

- ▶ Adjust the seat properly before beginning your journey.
- ▶ Always ensure that the seat backrest is in an almost vertical position and that the shoulder belt is routed across the center of your shoulder.

⚠ WARNING Risk of injury due to head restraints not being installed or being adjusted incorrectly

If head restraints have not been installed or have not been adjusted correctly, there is an increased risk of injury in the head and neck area, e.g. in the event of an accident or when braking.

- ▶ Always drive with the head restraints installed.
- ▶ Before driving off, make sure for every vehicle occupant that the center of the head restraint supports the back of the head at about eye level.

❗ NOTE Damage to the seats and the seat heating from fluids, pointed objects or insulating materials

To prevent damage to the seats and the seat heating, observe the following notes:

- ▶ Do not spill liquids onto the seats. Dry the seats as soon as possible if liquid does get spilled on the seats.
- ▶ If the seat covers are damp or wet, do not switch on the seat heating. Do not use the seat heating to dry the seats.
- ▶ Clean the seats as recommended; see the "Cleaning and care" section.
- ▶ Do not transport heavy loads on the seats. Do not place pointed objects on the seats such as knives, nails or tools. Where possible, use the seats only for carrying passengers.
- ▶ When operating the seat heating, do not cover the seats with insulating materials, e.g. blankets, coats, bags, protective covers, child seats or booster seats.

Adjusting the seat fore-and-aft position

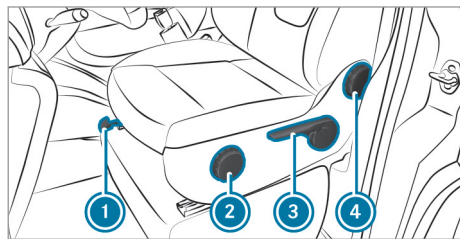

- ① Seat fore-and-aft position adjustment
- ② Seat angle adjustment
- ③ Seat height adjustment
- ④ Seat backrest adjustment

- ▶ Pull lever ① upwards and slide the seat forwards or back until the desired position has been reached.
- ▶ Release lever ① and slide the seat forwards or back until the desired position has been reached.

ⓘ For front swivel seats, the lever in position ① is used to release the swivel seat. The lever to adjust the fore-and-aft position is in the form of a bar in front of the seat .

Adjusting the seat height

- ▶ Pull or push lever ③ repeatedly until the desired seat height has been reached.

Adjusting the seat backrest

- ▶ Turn handwheel ④ forwards. The seat backrest will move to a vertical position.
- ▶ Turn handwheel ④ backwards. The seat backrest will tilt back.

Adjusting the seat angle

- ▶ Turn handwheel ② forwards. The front of the seat surface will tilt down.
- ▶ Turn handwheel ② backwards. The front of the seat surface will tilt up.

Adjusting the front seat electrically

⚠ WARNING Risk of becoming trapped if the seats are adjusted by children

Children could become trapped if they adjust the seats, particularly when unattended.

- ▶ When leaving the vehicle, always take the SmartKey with you and lock the vehicle.
- ▶ Never leave children unattended in the vehicle.

The seats can be adjusted when there is no key in the ignition lock.

⚠ WARNING Risk of accident due to adjusting the vehicle settings while the vehicle is in motion

You could lose control of the vehicle in the following situations in particular:

- If you adjust the driver's seat, the head restraint, the steering wheel or the mirror while the vehicle is in motion
 - If you fasten your seat belt while the vehicle is in motion
- ▶ Before starting the engine: In particular, adjust the driver's seat, head restraint, steering wheel and mirror, and fasten your seat belt.

⚠ WARNING Risk of injury or death due to the front seat being positioned too close to the cockpit

The front airbags can also injure the occupants in the front of the vehicle.

- ▶ Always adjust the front seats so they are as far away as possible from the front airbags.
- ▶ In addition, observe the notes on correct seat adjustment.

⚠ WARNING Risk of injury or death due to an incorrect seat position

The seat belt does not offer the intended level of protection if you have not moved the seat backrest to an almost vertical position.

In particular, you could slip beneath the seat-belt and become injured.

- ▶ Adjust the seat properly before beginning your journey.
- ▶ Always ensure that the seat backrest is in an almost vertical position and that the shoulder belt is routed across the center of your shoulder.

⚠ WARNING Risk of injury due to head restraints not being installed or being adjusted incorrectly

If head restraints have not been installed or have not been adjusted correctly, there is an increased risk of injury in the head and neck area, e.g. in the event of an accident or when braking.

- ▶ Always drive with the head restraints installed.
- ▶ Before driving off, make sure for every vehicle occupant that the center of the head restraint supports the back of the head at about eye level.

! **NOTE** Damage to the seats and the seat heating from fluids, pointed objects or insulating materials

To prevent damage to the seats and the seat heating, observe the following notes:

- ▶ Do not spill liquids onto the seats. Dry the seats as soon as possible if liquid does get spilled on the seats.

- ▶ If the seat covers are damp or wet, do not switch on the seat heating. Do not use the seat heating to dry the seats.
- ▶ Clean the seats as recommended; see the "Cleaning and care" section.
- ▶ Do not transport heavy loads on the seats. Do not place pointed objects on the seats such as knives, nails or tools. Where possible, use the seats only for carrying passengers.
- ▶ When operating the seat heating, do not cover the seats with insulating materials, e.g. blankets, coats, bags, protective covers, child seats or booster seats.

Requirements:

- The ignition is switched on or the door is open.

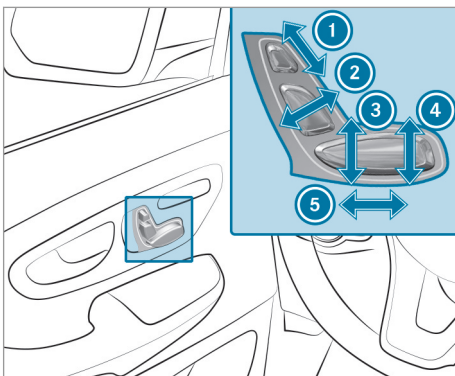

- ① Head restraint height adjustment
- ② Seat backrest inclination adjustment
- ③ Seat height adjustment
- ④ Seat angle adjustment
- ⑤ Seat fore-and-aft position adjustment

▶ Adjust the seat using buttons ① to ⑤ on the door trim.

If the ignition is not switched on, you can adjust the seat within 30 seconds of unlocking the vehicle.

① **Vehicles with PRE-SAFE®:** if PRE-SAFE® intervenes, the front passenger seat will automatically be adjusted from a less favorable position into one that offers better protection. The front passenger seat can be readjusted only after the hazardous situation

is over. Information about the system can be found under "PRE-SAFE®".

① You can save the settings for the seat with the memory function (→ page 65).

Setting 4-way lumbar support

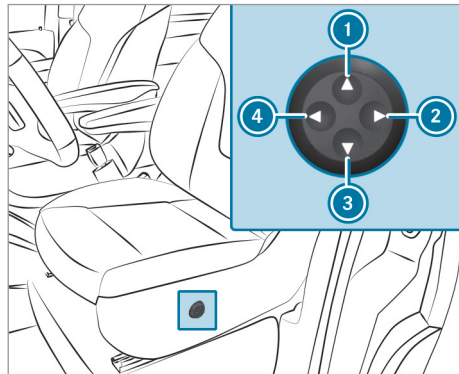

- ① Higher
- ② Weaker
- ③ Lower
- ④ Stronger

▶ Use buttons ① to ④ adjust the backrest contour individually to your spine.

Operating the memory function

⚠ WARNING Risk of an accident if the memory function is used while driving

If you use the memory function on the driver's side while driving, you could lose control of the vehicle as a result of the adjustments being made.

▶ Only use the memory function on the driver's side when the vehicle is stationary.

⚠ WARNING Risk of entrapment when adjusting the seat with the memory function

When the memory function adjusts the seat, you and other vehicle occupants – particularly children – could become trapped.

▶ During the adjustment process of the memory function, make sure that no

one has any body parts in the sweep of the seat.

- ▶ If somebody becomes trapped, immediately release the memory function position button. The adjustment process is stopped.

⚠ WARNING Risk of entrapment if the memory function is activated by children

Children could become trapped if they activate the memory function, particularly when unattended.

- ▶ Never leave children unattended in the vehicle.
- ▶ When leaving the vehicle, always take the SmartKey with you and lock the vehicle.

The memory function can be used when the ignition is switched off.

❗ NOTE Damage to the seat when moving into a stored position

If the seat is moved out of the fully reclined position into a stored seat position, it can collide with other vehicle parts.

This can damage the seat.

- ▶ Before moving the seat into a stored position, move the seat backrest into an upright position.

Storing seat settings

Seat settings for up to three people can be stored and called up using the memory function. The position of the seat, seat backrest and head restraint are stored as a single memory preset.

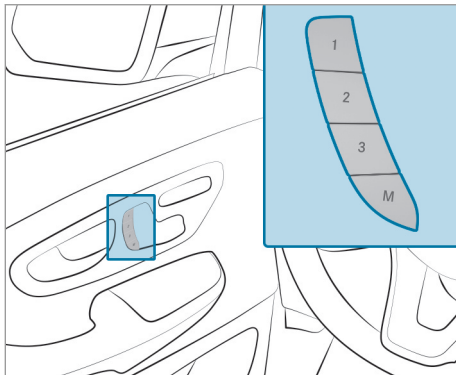

- ▶ Adjust the seat to the desired position.
- ▶ Briefly press memory button **M** and then press preset position button **1**, **2** or **3** within three seconds.

An acoustic signal sounds. The settings are stored.

- ▶ **To call up:** press and hold preset position button **1**, **2** or **3** until the seat is in the stored position.

Adjusting armrests

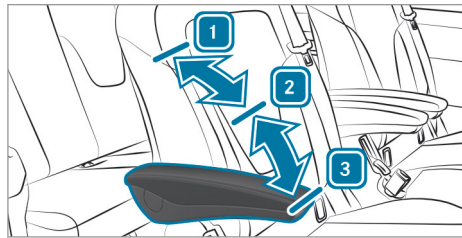

- ▶ Fold the armrest upwards more than 45° in position **2**. The armrest will be unlocked.
- ▶ Fold the armrest forwards **3** as far as it will go.
- ▶ Slowly fold the armrest upwards into the required position.
- ▶ **To fold the armrest upwards:** if necessary, fold the armrest upwards more than 90° in position **1**.

Rear bench seats

Notes on the rear seats

Bench seat anchorage

Keep the seat anchorages in the vehicle floor free of dirt and objects at all times to ensure that the seat engages securely.

⚠ WARNING Risk of accident and injury as a result of rear bench seat not being engaged

If the rear bench seat is not engaged, it may be flung around during travel.

- ▶ Always make sure that the rear bench seat is engaged as described.

Keep the seat anchorages in the vehicle floor free of dirt and objects at all times to ensure that the seat engages securely.

If the indicator tab of the anchorage is not retracted into the seat leg, the seat is not correctly engaged. Engage the seat again.

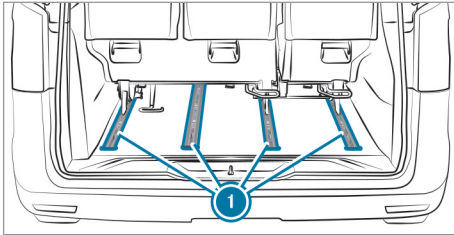

Example: seat rail system with quick-locking mechanism

Guide rails ❶ of the seat rail system can be used to mount up to two rear bench seats in two rows.

❶ **Vehicles with seat rail systems:** When you remove a rear bench seat, the seat slider may slide into a guide rail. The seat sliders will then no longer be parallel in the guide rails. In this case, you will no longer be able to install the rear bench seat. The seat sliders must be moved only using a special tool or at a qualified specialist workshop in order to prevent the risk of damage. The tool is available as a Mercedes-Benz accessory.

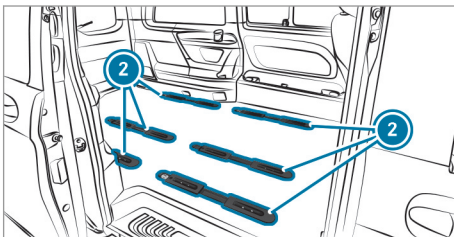

Seat anchorages with quick-locking mechanism (example: three seat anchorages per row of rear seats)

You can secure rear bench seats in seat anchorages ❷. If your vehicle is equipped with four seat anchorages on the first rear seat row, the rear bench seats can be mounted facing one another.

Seating variants

⚠ WARNING Risk of injury due to incorrect installation of the rear bench seats

The integrated safety precautions in the rear bench seats cannot perform their intended protective function.

- ▶ Always install the rear bench seats as described.
- ▶ Use only rear bench seats approved for your vehicle.

Depending on the type of seat anchorage in the vehicle floor, you can install the following seating variants:

- Rear bench seats with two or three seats
- Seat/bunk combination with three seats

Depending on the vehicle equipment, you can install the rear bench seats on the first and/or second rear seat row.

The seating variants shown are permitted only if the conditions specified below for safe rear seating are met. Other seating variants are not permitted and may endanger the occupants.

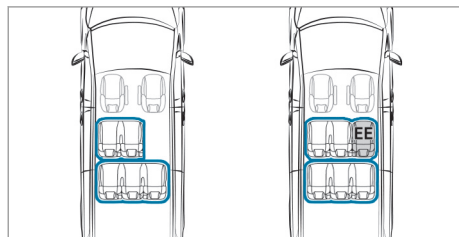

EE Easy entry and exit feature - EASY-ENTRY

If a rear bench seat is marked with EE in the illustrations, a rear bench seat must be installed with the EASY-ENTRY easy entry and exit feature in the position indicated.

If a rear bench seat is not marked, a rear bench seat can be installed with or without an EASY-ENTRY/EXIT section in the position indicated.

Please observe the following conditions for safe rear seating:

- Use only rear bench seats approved for the vehicle.
- A rear bench seat with three seats without the EASY-ENTRY feature may be installed only if there is no other rear seat row behind it.
- Passengers can use the seats only if the rear bench seat has been correctly engaged (→ page 69).

Using the EASY-ENTRY easy entry and exit feature (rear bench seat)

⚠ WARNING Risk of accident and injury as a result of rear bench seat not being engaged

If the rear bench seat is not engaged, it may be flung around during travel.

- ▶ Always make sure that the rear bench seat is engaged as described.

In order to ensure that the rear bench seat can securely engage, keep the seat guide rails and anchorages in the vehicle floor free of dirt and foreign objects.

If the indicator tab of the seat anchorage is not retracted into the seat leg, the seat is not correctly engaged. Engage the seat again.

⚠ WARNING Risk of becoming trapped when adjusting the rear bench seat

When adjusting a rear bench seat, you or another vehicle occupant could become trapped by the guide rail of the rear bench seat, for example.

- ▶ Make sure that no one has any part of their body within the sweep of the rear bench seat when adjusting the rear bench seat.

⚠ WARNING Risk of becoming trapped due to the rear bench seat not being engaged

The rear bench seat will not engage when folded forward. The rear bench seat may inadvertently fold back while the vehicle is accelerating, braking or changing direction suddenly or in the event of an accident, for example.

People within the sweep of the rear bench seat may become trapped.

- ▶ Always fold back a rear bench seat that has been folded forward before you start driving.
- ▶ Ensure that the rear bench seat is engaged.

Folding the EASY-ENTRY section forwards and back

If you fold the EASY-ENTRY section of the rear bench seat forwards, it is easier to get into or out of the second rear seat row.

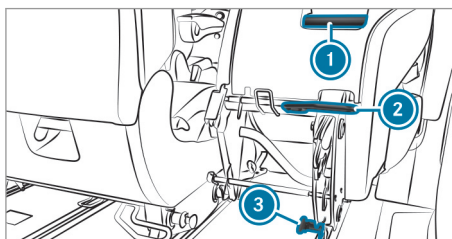

Rear bench seat with EASY-ENTRY feature (example: comfort rear bench seat)

- ① Grab handle
- ② EASY-ENTRY release handle
- ③ Release handle for front seat anchorages

- ▶ Pull EASY-ENTRY release handle ② upwards.
- ▶ Fold the EASY-ENTRY section forwards with the aid of grab handle ①.
- ▶ **To fold the EASY-ENTRY section back:** fold the EASY-ENTRY section back until it engages in the seat anchorages. The indicator tab will no longer be visible.

- ⓘ The EASY-ENTRY section is correctly engaged when the seat anchorage engages audibly and the indicator tab is no longer visible and is fully retracted into the seat anchorage.

Removing the EASY-ENTRY section

- ▶ **Vehicles with comfort rear bench seat:** Fold the seat backrest forward.
- ▶ Pull EASY-ENTRY release handle ② upwards.
- ▶ Fold the EASY-ENTRY section forwards with the aid of grab handle ①.
- ▶ Pull release handle ③ for the front seat anchorages upwards.
- ▶ Fold the EASY-ENTRY section further forwards.
- ▶ Lift the EASY-ENTRY section up and out of the anchorage.

Installing the EASY-ENTRY section

- ▶ Place and engage the front seat anchorage of the EASY-ENTRY section on the seat anchorages.
- ▶ Fold the EASY-ENTRY section back. The rear seat leg of the EASY-ENTRY section will engage audibly. The indicator tab on the seat anchorage will no longer be visible.
- ⓘ The EASY-ENTRY section is correctly engaged when the seat anchorage engages audibly and the indicator tab is no longer visible and is fully retracted into the seat anchorage.
- ▶ **Vehicles with comfort rear bench seat:** Fold the seat backrest back to the seat position.

Moving the rear bench seat (standard and comfort rear bench seat)

⚠ WARNING Risk of becoming trapped when adjusting the rear bench seat

When adjusting a rear bench seat, you or another vehicle occupant could become trapped by the guide rail of the rear bench seat, for example.

- ▶ Make sure that no one has any part of their body within the sweep of the rear bench seat when adjusting the rear bench seat.

⚠ WARNING Risk of injury due to moving the rear bench seat while the vehicle is in motion

If you move the rear bench seat while driving, the seat may move in an unexpected or jerking manner, for instance when braking.

You could become trapped as well as thrown against parts of the vehicle interior or other vehicle occupants.

- ▶ Only move the rear bench seat when the vehicle is stationary.
- ▶ Make sure that the rear bench seat is engaged after it is moved.

⚠ WARNING Risk of injury due to no protective effect from the window airbag

If you move the seat position outside the marked area, the window airbag can no longer provide optimum protection.

The protective effect of the window airbag is gradually reduced and may in some positions no longer be provided at all.

- ▶ Engage the rear seats or the rear bench seat on the guide rail within the marked area.

⚠ WARNING Risk of injury from the front seat being positioned too close to vehicle occupants

If you move the rear seats or the rear bench seat outside the markings on the guide rail, this could result in the vehicle occupant striking their head on the seat.

- ▶ Maintain a minimum clearance of 2 in (5 cm) between the knees of the respective vehicle occupants and the seat in front of them.

Requirements:

- The vehicle is equipped with a seat rail system in the vehicle floor.

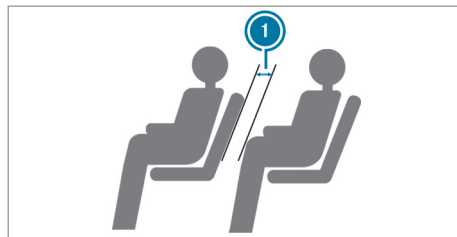

Maintain a minimum clearance of 2 in (5 cm) **ⓘ** between the knees of the vehicle occupants and the seats in front of them.

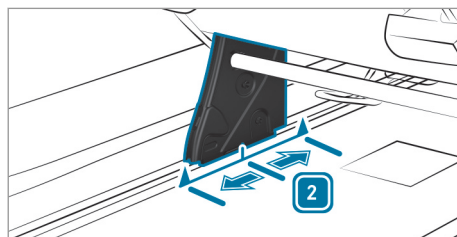

Starting from the basic setting **2**, the rear bench seat for passengers can be moved forwards or backwards by 2 in (5 cm). In doing so, make sure that passengers have sufficient legroom to reduce the risk of injury during braking.

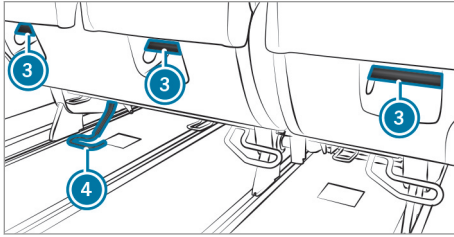

Example: comfort rear bench seat

You can slide the rear bench seat only when it is unoccupied. If possible, slide the rear bench seat with the assistance of a second person.

- ▶ Pull up release handle ④ for seat fore-and-aft adjustment.
- ▶ Move the rear bench seat to the desired position by grab handles ③.
- ▶ Let go of release handle ④. Release handle ④ will fold down to its original position.
- ▶ Make sure that all sliders for fore-and-aft adjustment engage audibly on both sides. It will no longer be possible to move the rear bench seat.

Folding the rear bench seat forwards and backwards

⚠ WARNING Risk of accident and injury as a result of rear bench seat not being engaged

If the rear bench seat is not engaged, it may be flung around during travel.

- ▶ Always make sure that the rear bench seat is engaged as described.

In order to ensure that the rear bench seat can securely engage, keep the seat guide rails and anchorages in the vehicle floor free from dirt and foreign objects.

If the indicator tab of the seat anchorage is not retracted into the seat anchorage, the seat is not correctly engaged. Engage the seat again.

⚠ WARNING Risk of becoming trapped due to the rear bench seat not being engaged

The rear bench seat will not engage when folded forward. The rear bench seat may inadvertently fold back while the vehicle is accelerating, braking or changing direction sud-

denly or in the event of an accident, for example.

People within the sweep of the rear bench seat may become trapped.

- ▶ Always fold back a rear bench seat that has been folded forward before you start driving.
- ▶ Ensure that the rear bench seat is engaged.

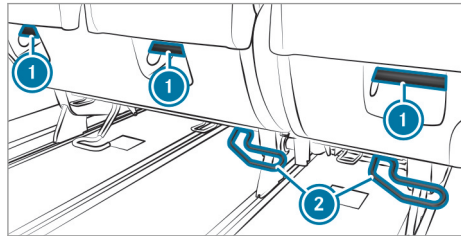

- ▶ Remove the head restraints (→ page 72).
- ▶ Fold the seat backrest forwards.
- ▶ Pull the release handles for rear seat anchorage ② up and tilt the rear bench seat.
- ▶ Grasp the rear bench seat by grab handles ① and fold the seat forwards.

Notes on the seat/bunk combination

⚠ WARNING Risk of becoming trapped when adjusting the rear bench seat

When adjusting a rear bench seat, you or another vehicle occupant could become trapped by the guide rail of the rear bench seat, for example.

- ▶ Make sure that no one has any part of their body within the sweep of the rear bench seat when adjusting the rear bench seat.

⚠ WARNING Risk of injury due to moving the rear bench seat while the vehicle is in motion

If you move the rear bench seat while driving, the seat may move in an unexpected or jerking manner, for instance when braking.

You could become trapped as well as thrown against parts of the vehicle interior or other vehicle occupants.

- ▶ Only move the rear bench seat when the vehicle is stationary.
- ▶ Make sure that the rear bench seat is engaged after it is moved.

⚠ WARNING Risk of injury due to no protective effect from the window airbag

If you move the seat position outside the marked area, the window airbag can no longer provide optimum protection.

The protective effect of the window airbag is gradually reduced and may in some positions no longer be provided at all.

- ▶ Engage the seat-/bunk combination on the guide rail within the marked area.

⚠ WARNING Risk of injury due to positioning the seat-/bunk combination outside the markings

If you move the seat/bunk combination outside the markings on the guide rail, this could result in the vehicle occupant striking their head on the seat.

- ▶ Maintain a minimum clearance of 2 in (5 cm) between the knees of the respective vehicle occupants and the seats in front of them.

! NOTE Damage to the seat/bunk combination when moving

If you grasp and push the seat/bunk combination by the storage compartment plastic cover only, the cover may break off.

If the space in front of or behind the seat/bunk combination is not clear, objects can become trapped when moving.

The seat/bunk combination, trim or the objects may become damaged.

- ▶ To move, use the loop between the seat backrest and sitting surface.
- ▶ When moving, make sure that the space in front of or behind the seat/bunk combination is clear.

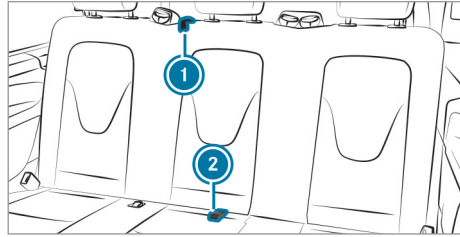

- ① Adjusts the seat backrest grab strap
- ② Moves the seat/bunk combination grab strap

Use only the corresponding grab straps ① and ② to adjust the seat/bunk combination.

The seat/bunk combination can accommodate three persons. You can adjust the seat backrest to a vertical and horizontal position. If you set the seat backrest to the horizontal position, this – together with the bed extension – will give you a full-length bed for two people.

Passengers may use the seats of the seat/bunk combination only when the seat backrest is upright. Only then do the seat belts provide the intended degree of protection.

The seat/bunk combination is equipped with two removable storage compartments under the seat surface. You can use these storage compartments to store bedding, for example.

Positioning the seats in the optimum area of protection

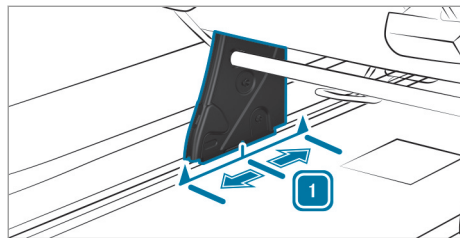

- ① Basic setting

Starting from the basic setting ①, the seat/bunk combination for passengers can be moved forwards or backwards by 13 in (5 cm). In doing so, make sure that passengers have sufficient legroom to reduce the risk of injury during braking.

Installing and removing the rear bench seat

⚠ WARNING Risk of accident and injury as a result of rear bench seat not being engaged

If the rear bench seat is not engaged, it may be flung around during travel.

▶ Always make sure that the rear bench seat is engaged as described.

Keep the seat guide rails and anchorages in the vehicle floor free of dirt and objects to ensure that the rear bench seat engages securely.

If the indicator tab of the seat anchorage is not retracted into the seat leg, the seat is not correctly engaged. Engage the seat again.

Removing the rear bench seat

You can install the rear bench seats in the face-to-face position only if the vehicle floor is equipped with four seat anchorages on the first rear seat row or with a seat rail system.

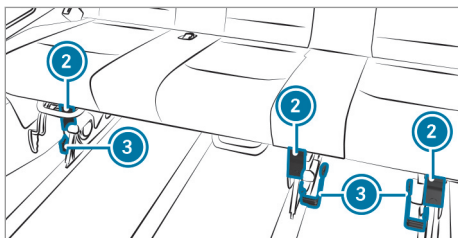
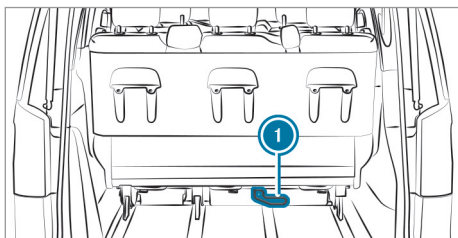

i In vehicles with a seat rail system, carry out the release, removal and subsequent re-installation of the rear bench seat at the marked at the marked basic position only (→ page 69).

- ▶ Fold the release handle for rear seat anchorage **1** up.
- ▶ Fold the rear bench seat forwards at the upper edge of the seat backrest.

- ▶ Pull the release handle for front seat legs **2** up.
- ▶ Grasp the rear bench seat by the lower edge of the seat cushion.
- ▶ Fold the rear bench seat forwards and remove it from seat anchorages **3**.

Installing the rear bench seat

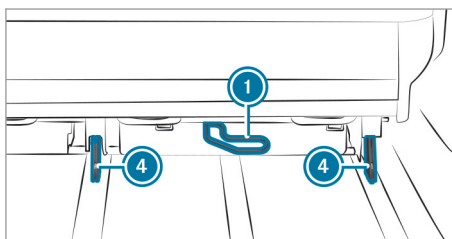

- ▶ Grasp the rear bench seat by the lower edge of the seat cushion.
- ▶ Insert the rear bench seat into front seat anchorages **3** from above at the front and allow it to engage.
- ▶ Make sure that the release handles for front seat legs **2** are folded down towards the floor of the vehicle.
- ▶ Fold the rear bench seat back into the seat position.
- ▶ Press the release handle for rear seat anchorage **1** down until indicator tabs **4** have fully retracted into the rear seat legs.

The rear seat legs of the rear bench seat are correctly engaged when the seat legs engage audibly and indicator tabs **4** on the seat legs are no longer visible and have fully retracted into the seat legs.

Head restraints

Adjusting the head restraint mechanically

⚠ WARNING Risk of accident due to adjusting the vehicle settings while the vehicle is in motion

You could lose control of the vehicle in the following situations in particular:

- If you adjust the driver's seat, the head restraint, the steering wheel or the mirror while the vehicle is in motion
- If you fasten your seat belt while the vehicle is in motion

- ▶ Before starting the engine: In particular, adjust the driver's seat, head restraint, steering wheel and mirror, and fasten your seat belt.

⚠ WARNING Risk of injury due to head restraints not being installed or being adjusted incorrectly

If head restraints have not been installed or have not been adjusted correctly, there is an increased risk of injury in the head and neck area, e.g. in the event of an accident or when braking.

- ▶ Always drive with the head restraints installed.
- ▶ Before driving off, make sure for every vehicle occupant that the center of the head restraint supports the back of the head at about eye level.

Do not interchange the head restraints of the front and rear seats. Otherwise, you will not be able to set the height and inclination of the head restraints to the correct position.

Using the head restraint fore-and-aft adjustment, adjust the head restraint so that it is as close to the back of the head as possible.

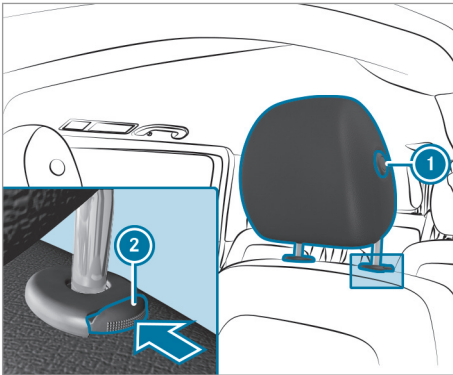

- ▶ **To raise:** pull the head restraint upwards into the required position and secure once the head restraint is engaged in the desired position. Use the head restraint only in the engaged state.
- ▶ **To lower:** push release button ② and slide the head restraint downwards into the

required position and ensure that the head restraint is engaged in the desired position. Use the head restraint only in the engaged state.

- ▶ **To move forwards:** push release button ① and pull the head restraint forwards until it engages in the required position.
- ▶ **To move backwards:** push release button ① and slide the head restraint backwards into the required position.
- ▶ **To remove:** press release knob ② and pull the head restraint up and out.
- ▶ **To install:** press the head restraint with detent into the holes on the left-hand side when viewed in the direction of travel until it engages.

Adjusting the head restraint electrically

⚠ NOTE Damage to the electrical head restraint when adjusted manually

If the height of the electrically adjustable head restraint is adjusted manually, this can damage the mechanism of the head restraint.

- ▶ Adjust the height of the electrically adjustable head restraints using the buttons in the door trim.

Requirements:

- The ignition is switched on or the door is open.

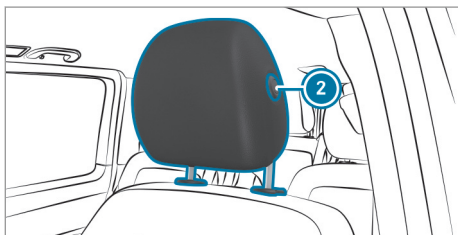
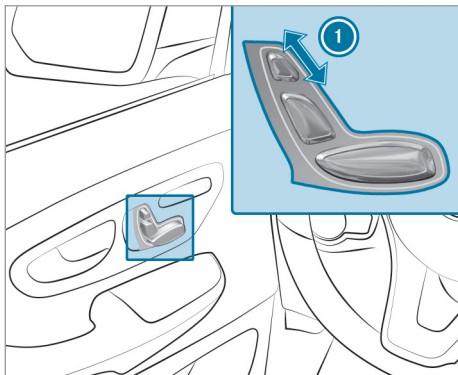

- ▶ **To adjust the height:** slide button ① up or down in the direction of the arrow.
- ▶ **To move forwards:** pull the head restraint forwards until it engages in the desired position.
- ▶ **To move backwards:** press and hold down release knob ② and slide the head restraint backwards to the desired position.

① If the ignition is not switched on, you can adjust the head restraint height within 30 seconds of unlocking the vehicle.

Switching the seat heating on/off

⚠ WARNING Risk of burns due to repeatedly switching on the seat heating

Repeatedly switching on the seat heating can cause the seat cushion and seat backrest padding to become very hot.

In particular, the health of persons with limited temperature sensitivity or a limited ability to react to high temperatures may be affected or they may even suffer burn-like injuries.

- ▶ Do not repeatedly switch on the seat heating.

To protect against overheating, the seat heating may be temporarily deactivated after it is switched on repeatedly.

! **NOTE** Damage to the seat heating due to overheating

The seat heating may overheat if the seat is unoccupied when the seat heating is switched on or if objects are placed on the seat.

- ▶ Switch off the seat heating when the seat is unoccupied.
- ▶ Do not place any objects on the seat when the seat is unoccupied.

Requirements:

- The power supply has been switched on.

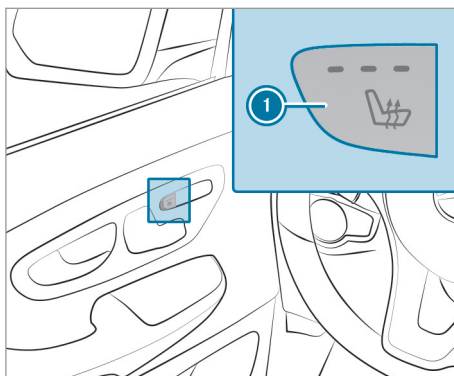
**Front seat**

- ▶ **To switch on/increase the level:** press button ① repeatedly until the desired heating level is set. Depending on the heating level, one to three indicator lamps will light up.
 - ▶ **To switch off/reduce the level:** press button ① repeatedly until the desired heating level is set. When all indicator lamps are off, the seat heating is switched off.
- ① The seat heating will automatically switch back out of the three heating levels after 7, 10 and 20 minutes until the seat heating switches off.

Storage areas

Storage spaces and storage compartments

Opening and closing the glove box

⚠ WARNING Risk of injury due to objects being stowed incorrectly

If objects in the vehicle interior are stowed incorrectly, they can slide or be thrown around and hit vehicle occupants. In addition, cup holders, open storage spaces and mobile phone brackets cannot always retain all objects they contain.

There is a risk of injury, particularly in the event of sudden braking or a sudden change in direction.

- ▶ Always stow objects in such a way that they cannot be thrown around in such situations.
- ▶ Always make sure that objects do not protrude from storage spaces, parcel nets or storage nets.
- ▶ Close the lockable storage spaces before starting a journey.
- ▶ Always stow and secure heavy, hard, pointed, sharp-edged, fragile or bulky objects in the trunk.

Comply with the instructions for loading the vehicle.

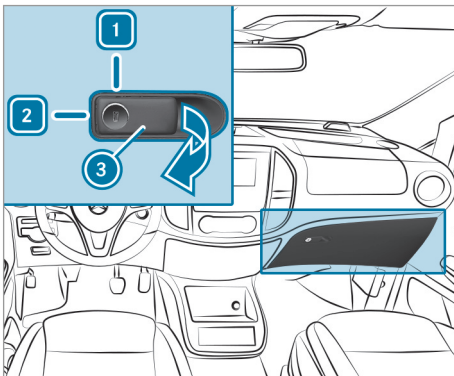

- 1 Unlocked
- 2 Locked
- 3 Glove box handle

- ▶ **To lock/unlock:** turn the emergency key a quarter turn counter-clockwise 2 (to lock) or clockwise 1 (to unlock).
- ▶ **To open:** pull glove box handle 3 in the direction of the arrow.
- ▶ **To close:** fold the glove box handle up and press it until it engages.

Using the storage net on the seat backrest

- ▶ Store lightweight small parts in the storage nets.

Opening the glasses compartment

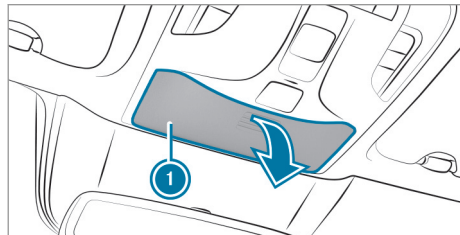

- ▶ Press button 1.

Information about the bottle holder

The bottle holders are in front of the storage compartments in the front doors.

There are additional bottle holders on the left and right in the rear compartment side trim.

Cup holders

Overview of cup holders in the cockpit

⚠ WARNING Risk of accident or injury if the cup holder is used while the vehicle is in motion

Cup and bottle holders cannot keep containers secure while the vehicle is in motion.

If you use a cup or bottle holder while the vehicle is in motion, the container may be flung around and liquids could be spilled. Vehicle occupants may come into contact with the liquid and if it is hot, they could be scalded. You could be distracted from traffic conditions and you may lose control of the vehicle.

- ▶ Use the cup and bottle holders only when the vehicle is stationary.

- ▶ Place only suitable containers in the cup and bottle holders.
- ▶ Close the containers, particularly if the liquid is hot.

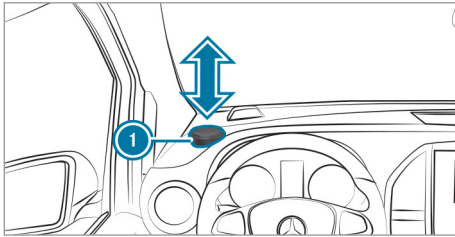

Cup holders ① are located at the upper left and right of the cockpit.

Ashtray and cigarette lighter

Using ashtrays

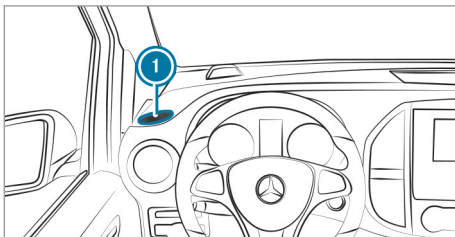

- ▶ The ashtray with cap ① can be inserted into a cup holder on the cockpit or into a cup holder in the rear passenger compartment.

Using the cigarette lighter in the front center console

⚠ WARNING - Risk of fire and injury from hot cigarette lighter

You can burn yourself if you touch the hot heating element or the socket of the cigarette lighter.

In addition, flammable materials may ignite if:

- you drop the hot cigarette lighter
 - a child holds the hot cigarette lighter to objects, for example
- ▶ Always hold the cigarette lighter by the knob.

- ▶ Always make sure that the cigarette lighter is out of reach of children.
- ▶ Never leave children unattended in the vehicle.

Requirements:

- The power supply has been switched on.

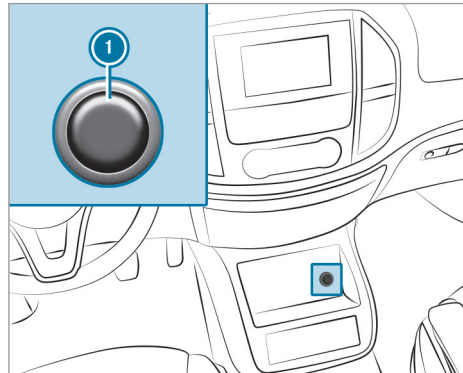

Cigarette lighter (example: vehicle with stowage compartment under the center console)

- ▶ Press in cigarette lighter ①.

Sockets

Using the 12 V socket in the front center console

Requirements:

- The power supply has been switched on.
- Only devices with up to a maximum of 180 watts (15 A) are permissible.

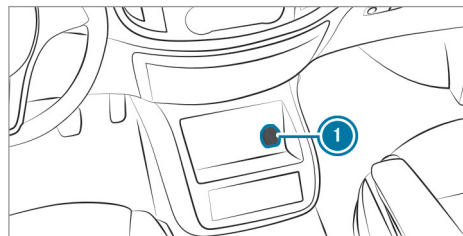

- ▶ Fold up cover ① of the socket.
- ▶ Insert the plug of the device.

Exterior lighting

Information about lighting systems and your responsibility

The vehicle's various lighting systems are only aids. The vehicle driver is responsible for adjusting the vehicle's lighting to the prevailing light, visibility, statutory conditions and traffic conditions.

Light switch

Operating the light switch

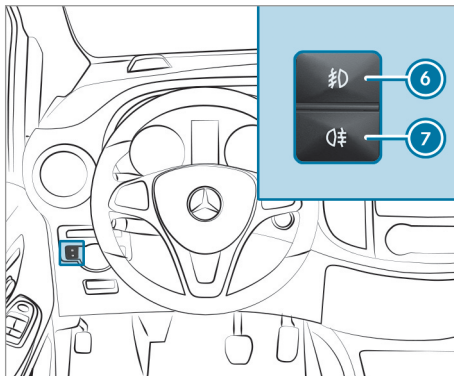
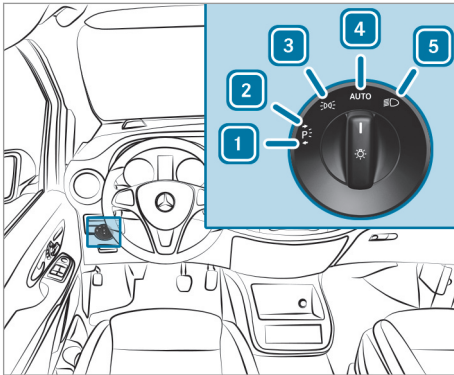

- 1 Left standing lamps
- 2 Right standing lamps
- 3 Parking lamps and license plate and instrument lighting
- 4 Lights off and daytime running lamps
- With light sensor: automatic driving lights (preferred light switch position)
- 5 Low beam or high beam

- 6 Front fog lights
- 7 Rear fog light

If you hear a warning tone when exiting the vehicle, the lights may still be on.

- ▶ Turn the light switch to or **AUTO**.

The exterior lighting (except standing and parking lamps) will automatically switch off in the following cases:

- If you remove the key from the ignition lock.
- If you open the driver's door while the key is in position in the ignition lock.

Switching on the daytime running lamps

- ▶ Turn the light switch to or **AUTO**.

Automatic driving lights function

The parking lamps, low beam and daytime running lights will be switched on automatically depending on the ignition status and the ambient light.

⚠ WARNING Risk of accident when the low beam is switched off in poor visibility

When the light switch is set to **AUTO**, the low beam may not be switched on automatically if there is fog, snow or other causes of poor visibility such as spray.

- ▶ In such cases, turn the light switch to .

The automatic driving lights are only an aid. Responsibility for vehicle lighting rests with you.

If the parking lamps and low beam have been switched on, the green (parking lamps) and (low beam) indicator lamps on the instrument cluster will light up.

Activating/deactivating the fog light

Requirements:

- The light switch is in the or **AUTO** position.
- The power supply has been switched on.
- **To switch on the fog light:** the vehicle is equipped with front fog lamps.

- ▶ **To switch the fog light on or off:** press the button.

- ▶ **To switch the rear fog lamp on or off:** press the button.

Comply with the country-specific regulations for using the rear fog lamp.

Adjusting headlamp range

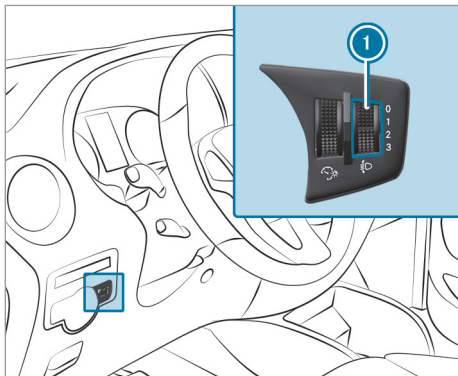

- ▶ Turn headlamp range adjuster ① to the required position.
- ▶ If the vehicle is unladen, select position 0.

The illumination of the road should be 131 ft (40 m) to 328 ft (100 m) and low beam must not blind oncoming traffic.

You can use the headlamp range adjuster to adjust the light cone of the headlamps to your vehicle's load condition. The light cone will change as the seats are occupied or the cargo compartment is loaded or unloaded. This can cause visibility conditions to deteriorate and you could blind oncoming traffic.

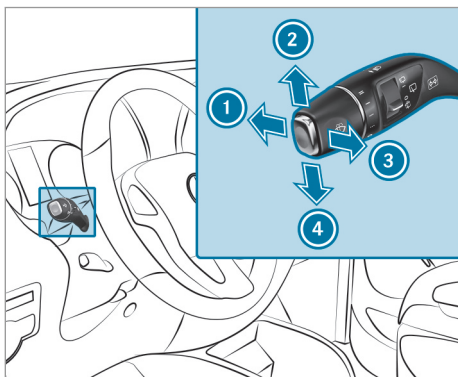

Operating the combination light switch



- ① High beam
- ② Right turn signal light
- ③ Headlamp flashing
- ④ Left turn signal light

- ▶ Use the combination switch to activate the desired function.

Switching on high beam

- ▶ Switch on the low beam (→ page 77).
- ▶ Push the combination switch forwards ①. The  indicator lamp on the instrument cluster will light up.
- ① The high beam switches to the **AUTO** position only in darkness and when the engine is running.
- ▶ **To switch off:** move the combination switch back to its starting position. The  indicator lamp on the instrument cluster will light up.

Headlamp flashing

- ▶ Briefly pull the combination switch in the direction of arrow ③.

Turn signal lights

- ▶ **To indicate:** push the combination switch in the required direction ② or ④ until it engages. In the case of larger steering movements, the combination switch will automatically switch back.
- ▶ **To indicate briefly:** tap the combination switch briefly in the required direction ② or ④. The corresponding turn signal lamp will flash three times.

Switching the hazard warning light system on/off

⚠ WARNING Risk of accident due to concealed lighting systems

If you open the rear-end doors by 90°, the rear lighting installations will be concealed.

Other road users will then not be able to see the vehicle, or will see it only with difficulty.

Therefore, in these or similar situations, safeguard the vehicle in accordance with national regulations, e.g. with a warning triangle.

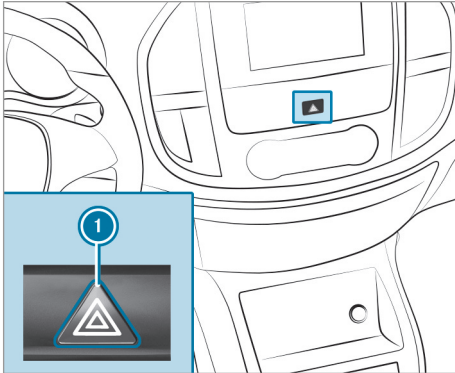

▶ Press button ①.

If you operate a turn signal indicator while the hazard warning light system is switched on, only the turn signal lamps on the relevant side of the vehicle will light up.

The hazard warning light system will switch on automatically in the following situations:

- The airbag is deployed
- The vehicle is heavily braked from a speed of more than 45 mph (70 km/h) to a standstill.

The hazard warning light system will automatically switch off when the vehicle regains a speed of more than 6 mph (10 km/h) after maximum full-stop braking.

① The hazard warning light system will work even when the vehicle has been switched off.

Highbeam Assist

Adaptive Highbeam Assist function

⚠ WARNING Risk of accident despite Adaptive Highbeam Assist

Adaptive Highbeam Assist does not react to:

- Road users without lights, e.g. pedestrians
- Road users with poor lighting, e.g. cyclists
- Road users whose lighting is obstructed, e.g. by a barrier

On very rare occasions, Adaptive Highbeam Assist may fail to recognize other road users with their own lighting, or may recognize them too late.

In these, or in similar situations, the automatic high beam will not be deactivated or will be activated despite the presence of other road users.

▶ Always observe the road and traffic conditions carefully and switch off the high beam in good time.

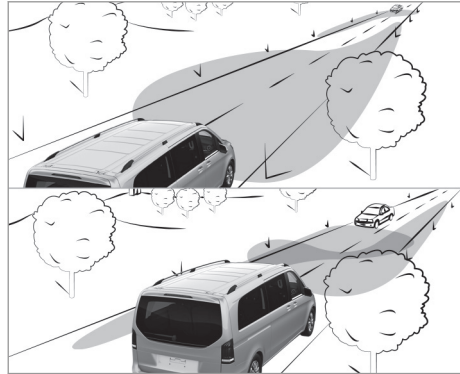

The Adaptive Highbeam Assist automatically switches between the following settings:

- Low beam
- High beam

The system detects that vehicle lights are approaching in the opposite direction or driving ahead of the vehicle.

If your speed is greater than 19 mph (30 km/h) and no other road users are detected, high beam will automatically be switched on.

If your speed is greater than 16 mph (25 km/h), the headlamp range will be controlled automatically depending on the distance from other road users.

High beam will automatically be deactivated in the following cases:

- Your speed is lower than 16 mph (25 km/h).
- Other road users have been detected.
- The road is sufficiently illuminated.

System limits

Adaptive Highbeam Assist cannot take the road, weather or traffic conditions into consideration.

The detection of obstacles may be restricted if:

- visibility is poor, e.g. in fog, heavy rain or snow.
- the sensors are dirty or covered.

Adaptive Highbeam Assist is only an aid. You are responsible for ensuring correct vehicle lighting in accordance with the prevailing light, visibility and traffic conditions.

The system's optical sensor is located behind the windshield near the overhead control panel.

Switching Highbeam Assist on/off

Requirements

- The light switch is in the **AUTO** position.

- ▶ **To switch on:** switch on high beam using the combination switch. If high beam is automatically switched on in darkness, the  indicator lamp on the multifunction display will light up.
- ▶ **To switch off:** switch off high beam using the combination switch.



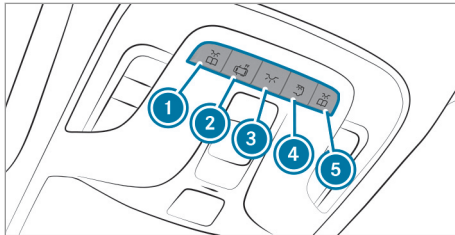

Adjusting the interior lighting

Adjusting the interior lighting

Front overhead control panel



Interior lighting buttons (example: comfort overhead control panel)

- ①  Front left reading lamp
- ②  Automatic interior lighting control
- ③  Front interior lighting
- ④  Rear compartment or cargo compartment lamp
- ⑤  Front right reading lamp

- ▶ **To switch on/off:** press the corresponding button ① - ⑤.

The layout and number of buttons depend on the equipment.

Operating unit in the grab handle

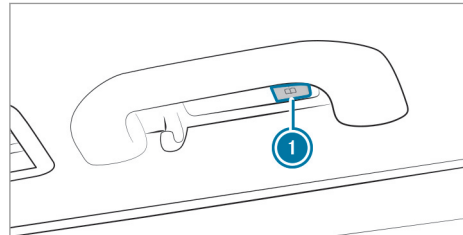

- ①  Rear compartment reading lamp

- ▶ **To switch on/off:** press button ①.

Operating unit in the cargo compartment

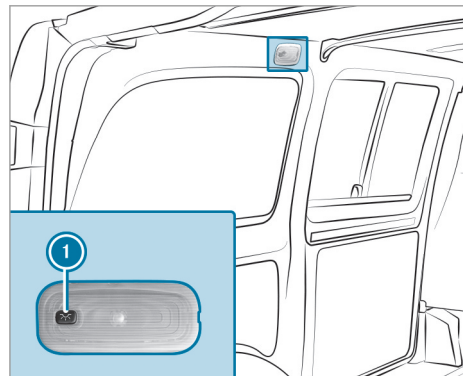

- ①  Cargo compartment lamp

- ▶ **To switch on/off:** press button ①.

If your vehicle is equipped with a cargo compartment lamp with a button, you can switch all cargo compartment lamps on and off by pressing the  button on this cargo compartment lamp.

Regardless of the switch position, you can switch the cargo compartment lamp on and off centrally by pressing the  button on the overhead control panel.

Changing bulbs

Notes for replacing light bulbs

⚠ WARNING Risk of burns from hot component parts whilst replacing a bulb

Bulbs, lamps and plug connectors can become very hot during operation.

When replacing a bulb, you could burn yourself on these component parts.

- ▶ Allow the component parts to cool down before replacing the bulbs.

When you are replacing the light bulb, observe the following:

- Do not use any light bulb that has been dropped or has scratches on its glass tube. Otherwise, the light bulb may explode.
- The bulb may explode if it is hot or if you touch, drop or scratch it.
- Stains on the glass tube will reduce the service life of the light bulb. Do not touch the glass tube with your bare hands. If necessary, clean the glass tube with alcohol or spirits while it is cold state and wipe it down with a lint-free cloth.
- Protect light bulbs from humidity and do not bring them into contact with liquids.
- Before changing the bulbs, switch off the vehicle's lighting system. This will prevent a short circuit.
- Use bulbs only in enclosed lamps that have been designed for them.
- Use only spare bulbs of the same type and with the correct voltage.

Always ensure the bulbs are firmly secured.

Have the following light bulbs changed at a qualified specialist workshop only:

- Bulbs in the license plate lamp
- Front fog lamp
- Side marker lamps

Bulbs and lamps are major elements in vehicle safety. Therefore, ensure that they are always working. Have the headlamp setting checked regularly.

If the new light bulb also does not light up, consult a qualified specialist workshop.

Replacing front light bulbs (vehicles with halogen headlamps)

Overview of front light source types

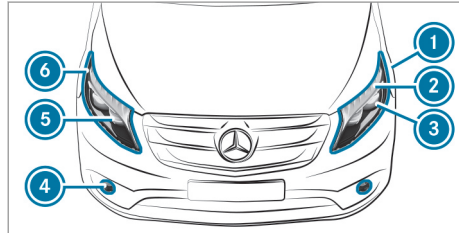

- ① Side additional turn signal lamp: WY 5 W
- ② Turn signal light: PY 21 W
- ③ Low beam: H7 55 W
- ④ Front fog lamp: H11 55 W
- ⑤ High beam/standing/parking lamps/daytime running lamps: H15 55 W/15 W
- ⑥ Side marker light: LED

Replacing light sources in the headlamp

Requirements:

- The lighting system is switched off.
- The appropriate front wheel is turned inwards.
- **Low beam:** you require a H7 55 W light bulb.
- **Turn signal light:** you require a PY 21 W light bulb.
- **High beam/standing/parking lamps/daytime running lamps:** you require a H15 55 W/15 W light bulb.

Installing/removing the cover in the front wheel arch

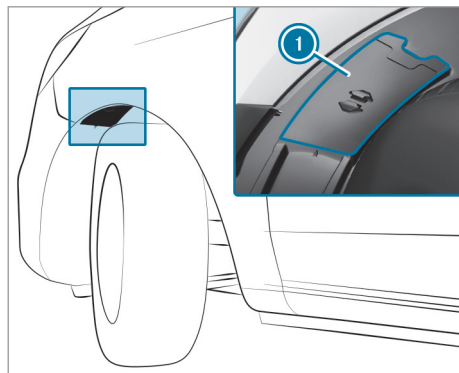

▶ **To remove:** grip the center of cover ❶, slide it upwards and pull it out. The cover will hang downwards on the strap.

▶ **To install:** insert cover ❶ at the top and slide it downwards until it engages.

Low beam

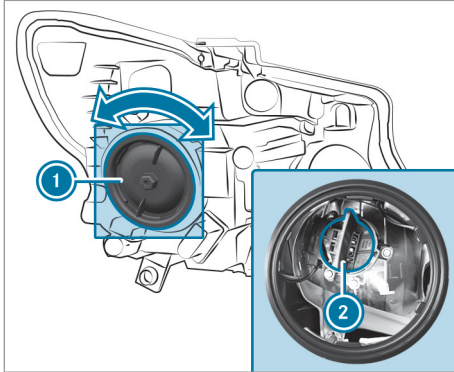

- ▶ Remove the cover in the front wheel arch.
- ▶ Turn housing cover ❶ counter-clockwise and remove it.
- ▶ Turn socket ❷ for low beam to the left and pull it out.
- ▶ Pull the bulb out of socket ❷.
- ▶ Insert the new bulb into socket ❷.
- ▶ Insert socket ❷ and rotate it to the right to tighten it.
- ▶ Press on housing cover ❶ and rotate it to the right to tighten it.
- ▶ Replace the cover in the front wheel arch.

High beam, standing/parking lamps and daytime running lamps

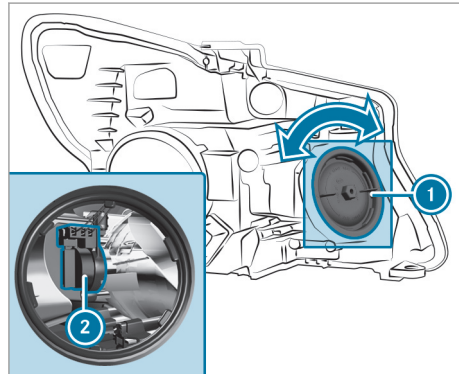

- ▶ Open the hood.
- ▶ Turn housing cover ❶ counter-clockwise and remove it.
- ▶ Pull out the bulb with socket ❷.
- ▶ Insert the new bulb with socket ❷ and engage it as far as it will go.
- ▶ Press on housing cover ❶ and rotate it to the right to tighten it.
- ▶ Close the hood.

Turn signal light

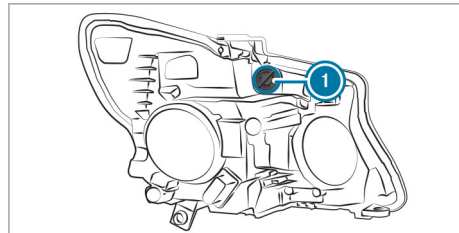

- ▶ Open the hood.
- ▶ Turn socket ❶ counter-clockwise and pull it out.
- ▶ Pull the bulb out of socket ❶.
- ▶ Insert the new bulb into socket ❶.
- ▶ Insert socket ❶ and turn it clockwise until it engages.
- ▶ Close the hood.

Replacing light bulbs in the side additional indicators

Requirements:

- The lighting system is switched off.
- You will need a WY 5 W bulb.

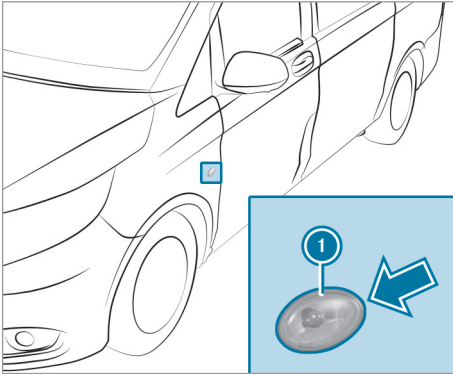

- ▶ Push additional indicator ① forwards and swivel it out.
- ▶ Push the bulb rearwards.
- ▶ Gently turn the bulb counter-clockwise and take it out of the socket.
- ▶ Insert the new bulb into the socket and turn it clockwise to screw it in.
- ▶ Align additional indicator ① at the front and engage it.

Replacing rear bulbs

Overview of rear compartment lamp types

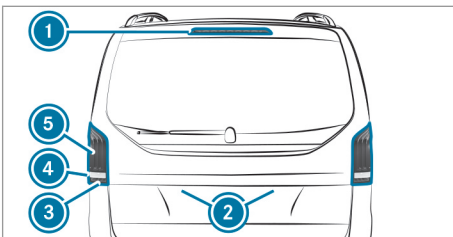

- ① Third brake light: LED
- ② Additional turn signal lamp on the roof: P 21 W
- ③ Rear fog lamp (driver's side): P 21 W
- ④ Backup lamp: P 21 W
- ⑤ Brake light, tail light/standing lamps/turn signal light: P 21 W side marker light: LED

Replacing light sources in the tail lamp

Requirements:

- The lighting system is switched off.
- **Standard tail lamp:** you require a P 21 W light source.
- **LED tail lamp:** you require a W 16 W light source.
- **Additional turn signal lamp on the roof:** you require a P 21 W light source.

Removing the tail lamp

! NOTE Damage to the paintwork during tail lamp removal

The paintwork may be damaged when the tail lamps are removed. The tail lamp may, for example, scratch the paintwork when it is removed.

- ▶ Remove the tail lamps carefully.
- ▶ Mercedes-Benz recommends having the tail lamp light sources replaced at a qualified specialist workshop.

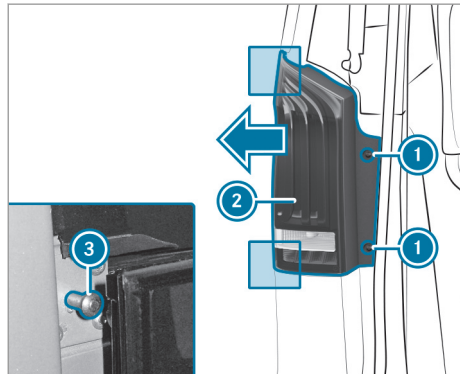

Please note that you can change the bulb of the backing up light only in the case of an LED tail lamp.

- ▶ Open the tailgate/rear-end door.
- ① You will find a screwdriver in the vehicle tool kit (→ page 201).
- ▶ Unscrew two side screws ①.
- ▶ Push tail lamp ② outwards against bolts ③ as far as it will go.
- ▶ Press tail lamp ② off outwards and away from bolts ③.

- ▶ Pull the connector off the bulb mount of tail lamp ②.

Installing the tail lamp

- ▶ Push the connector into the bulb mount of tail lamp ②.
- ▶ Push tail lamp ② onto bolts ③ from the side and press it against the vehicle.
- ▶ Tighten two side screws ①.

Standard tail lamp

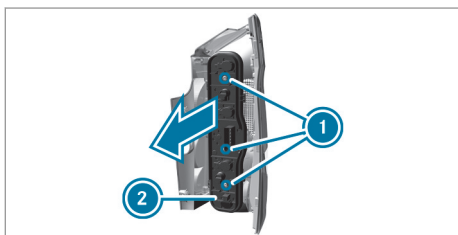

- ▶ Unscrew three screws ① and remove bulb mount ② from the tail lamp.

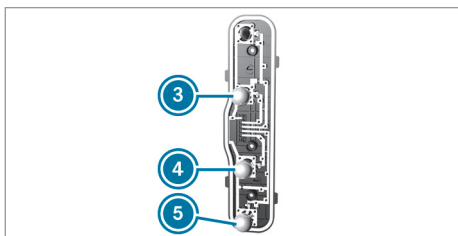

Bulb mount

- ③ Turn signal light, brake light, tail light, standing lamps
- ④ Backing up light
- ⑤ Rear fog lamp (only on the driver's side)
- ▶ Remove the tail lamp.
- ▶ Gently turn the bulb counter-clockwise and take it out of the socket.
- ▶ Push the new bulb into the socket and turn it clockwise to screw it in.
- ▶ Insert bulb mount ② into the tail lamp and tighten all three screws ①.
- ▶ Install the tail lamp.

Replacing interior light bulbs

Replacing light sources in the interior

Requirements:

- The interior lighting has been switched off.
- **Rear compartment and cargo compartment lamp:** you require a T10 6W xenon light source.
- **Interior and surround lighting:** you require a W 5 W light source.
- **Signal and ambient lamp in the tailgate:** you require a W 5 W light source.

Rear compartment and cargo compartment lamps

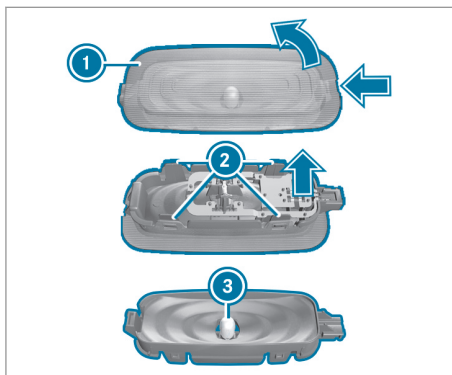

- ▶ Push in the catch spring of lens ① with a suitable object, e.g. a screwdriver, and then pry off the lens with the lamp housing.
- ▶ Push the lugs of socket ② inwards.
- ▶ Remove light source ③ from the lamp housing.
- ▶ Insert the new light source.
- ▶ Position the lens on the lamp housing and engage it.
- ▶ Align the lens with the lamp housing and engage it.

Additional interior and surround lighting

Depending on the equipment, replacing the light sources as described here applies to the following lamps:

- The sun visor mirror lamp
- The ambient lamp at the bottom of the front door
- The ambient lamp on the inside of the tailgate

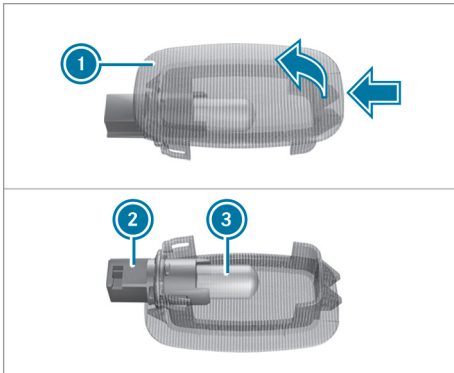

- ▶ Push in the catch spring of lamp housing ① with a suitable object, e.g. a screwdriver, and pry off lamp housing ①.
- ▶ Turn socket ② counter-clockwise and pull it out of lamp housing ①.
- ▶ Pull bulb ③ out of socket ②.
- ▶ Push new bulb ③ into socket ②.
- ▶ Screw socket ② into the lamp housing ① by turning it clockwise.
- ▶ Place lamp housing ① in position on the left and engage it.

Signal and ambient lamp in the tailgate

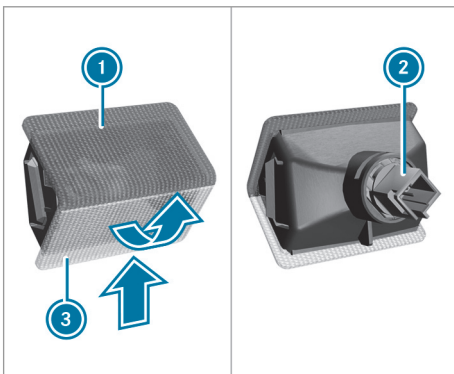

- ▶ Push in the catch spring of the lamp housing on the side of transparent lens ② with a suitable object, e.g. a screwdriver, and pry off the lamp housing.
- ▶ Turn socket ③ counter-clockwise and pull it out of the lamp housing.
- ▶ Pull the bulb out of socket ③.
- ▶ Push the new bulb into socket ③.

- ▶ Screw socket ③ into the lamp housing by turning it clockwise.
- ▶ Place the lamp housing in position at the side of red lens ① and engage it.

Windshield wipers

Switching the windshield wipers on and off

Requirements:

- The power supply has been switched on.

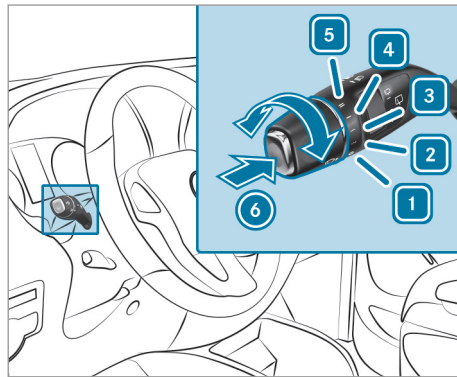

- 1 0 Windshield wipers off
- 2 ... Intermittent wiping, low (low rain sensor sensitivity)
- 3 Intermittent wiping, high (high rain sensor sensitivity)
- 4 — Continuous wiping, slow
- 5 = Continuous wiping, fast





- ▶ Turn the combination switch to the corresponding position 1 - 5.
- ▶ **Single wiping:** push the button on the combination switch in the direction of arrow ⑥.
- ▶ **To wash:** push the button on the combination switch in the direction of arrow ⑥ as far as the second point of resistance.

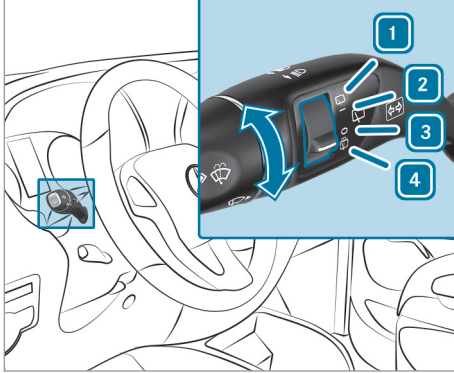

Switching the rear window wiper on/off

Requirements:

- The power supply has been switched on.



- 1  Wiping with washer fluid
- 2  Intermittent wiping
- 3  Rear window wiper off
- 4  Wiping with washer fluid

- ▶ Move the  switch to the corresponding position. The  symbol will appear on the instrument cluster when the rear window wiper is switched on.

In vehicles with steering-wheel buttons, the on-board computer will show the  symbol on the [Assistance Graphic](#) menu.

- ▶ **To wipe with washer fluid:** push the  switch beyond its current position as far as it will go towards 1 or 4 and hold it there.

Replacing the windshield wiper blades

▲ WARNING Risk of becoming trapped if the windshield wipers are switched on while wiper blades are being replaced

If the windshield wipers begin to move while you are changing the wiper blades, you can be trapped by the wiper arm.

- ▶ Always switch off the windshield wipers and the ignition before changing the wiper blades.

! NOTE Damage to the windshield or rear window during wiper blade replacement

If the wiper arm on the windshield or rear window is folded back before a wiper blade has been installed, the window may be damaged by the force of the impact.

- ▶ Never fold the wiper arm on the windshield or rear window back until a wiper blade has been installed. Keep hold of the wiper arm when replacing a wiper blade.

! NOTE Damage to hood or windshield wipers when opening the hood

If the windshield wipers have been folded back from the windshield when the hood is opened, the windshield wipers or the hood may be damaged.

- ▶ Ensure that the windshield wipers have not been folded back from the windshield.

Removing the wiper blades

- ▶ Fold the wiper arms away from the windshield.

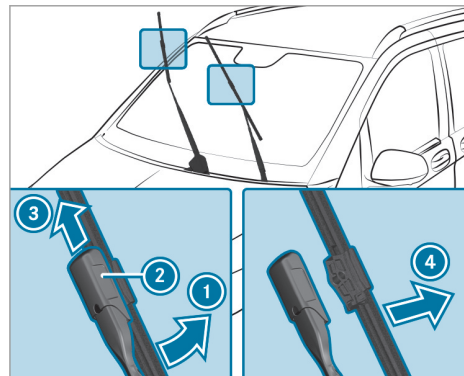

- ▶ Hold the wiper arm with one hand. With the other hand, turn the wiper blade in the direction of arrow 1 away from the wiper arm as far as it will go.
- ▶ Slide catch 2 in the direction of arrow 3 until it engages in the removal position.
- ▶ Remove the wiper blade from the wiper arm in the direction of arrow 4.

Installing the wiper blades

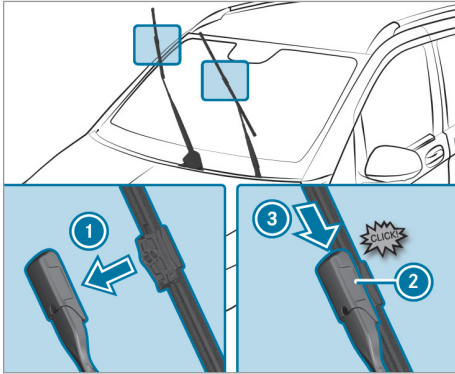

- ▶ Insert the new wiper blade into the wiper arm in the direction of arrow ①.
- ▶ Slide catch ② in the direction of arrow ③ until it engages in the locking position.
- ▶ Make sure that the wiper blade is seated correctly.
- ▶ Fold the wiper arms back onto the windshield.

Maintenance display

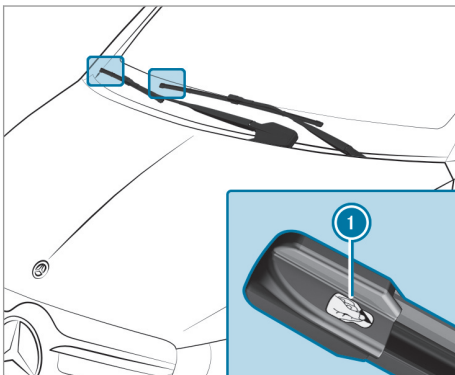

- ▶ Remove protective film ① from the maintenance displays on the tips of the newly installed wiper blades.

If the color of the maintenance display changes from black to yellow, the wiper blades should be replaced.

- ① The time until the color changes varies depending on the usage conditions.

Replacing the rear window wiper blade

Tailgate

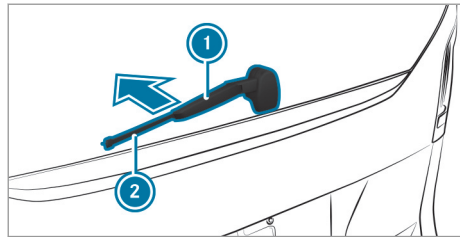

- ▶ Fold wiper arm ① away from the rear window until it engages in the replacement position.
- ▶ Hold wiper arm ① firmly and pull wiper blade ② off the wiper arm in the direction of the arrow.
- ▶ Place new wiper blade ② on wiper arm ①.
- ▶ Hold wiper arm ① firmly and push wiper blade ② in the opposite direction to the arrow until it engages.
- ▶ Make sure that wiper blade ② is seated correctly.
- ▶ Fold wiper arm ① back onto the rear window.

Rear-end doors

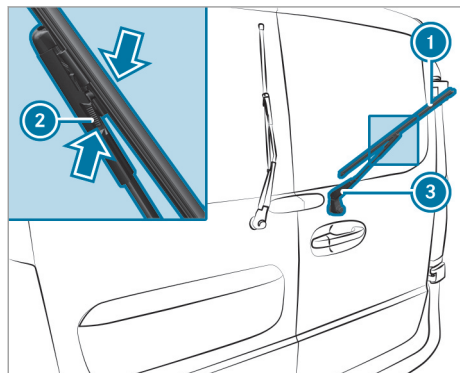

- ▶ Fold wiper arm ③ away from the rear window.
- ▶ Press two retaining clips ② together in the direction of the arrow and swivel the wiper blade away from the wiper arm.
- ▶ Pull wiper blade ① upwards out of the holder on wiper arm ③.

- ▶ Insert new wiper blade ① in the holder on wiper arm ③.
- ▶ Push new wiper blade ① onto wiper arm ③ until the retaining clips engage.
- ▶ Fold wiper arm ③ back onto the rear window.

Mirrors

Operating the outside mirrors

⚠ WARNING Risk of accident due to adjusting vehicle settings while the vehicle is in motion

You could lose control of the vehicle in the following situations in particular:

- If you adjust the driver's seat, the head restraints, the steering wheel or the mirror while the vehicle is in motion.
- If you fasten your seat belt while the vehicle is in motion.

▶ Before starting the engine: adjust the driver's seat, the head restraints, the steering wheel and the mirror and fasten your seat belt.

⚠ WARNING Risk of accident due to misjudgment of distance when using the front-passenger mirror

The outside mirror on the front passenger side reflects objects on a smaller scale.

▶ Therefore, always look over your shoulder in order to ensure that you are aware of the actual distance between you and the road users driving behind you.

Adjusting the outside mirrors manually

- ▶ Adjust the outside mirrors to the correct position manually.

Adjusting the outside mirrors electrically

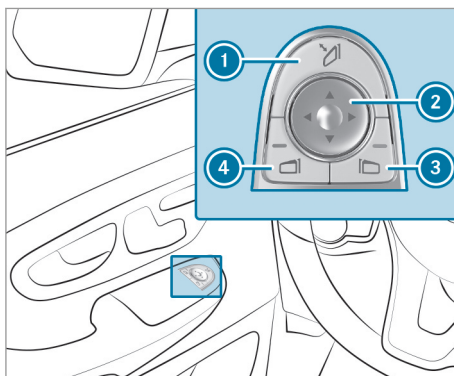

- ▶ Switch on the power supply or the ignition.
- ▶ Press button ③ or ④ to select the outside mirror to be adjusted.
- ▶ Set the position of the mirror glass using button ②.

Folding the electric outside mirrors in/out

ⓘ NOTE Damage to the electric outside mirrors

If you fold the electric outside mirrors in or out manually, you may damage the outside mirrors and they will not lock in place properly.

If the outside mirrors are not folded in when washing the vehicle in a car wash, the washer brushes may fold them in forcibly and damage them.

- ▶ The outside mirrors must only be folded in and out electrically.
- ▶ Fold the outside mirrors in before washing the vehicle in a car wash.

- ▶ Switch on the power supply or the ignition.
- ▶ Briefly press button ①.

You will no longer be able to fold in the outside mirrors once you reach a speed greater than 29 mph (47 km/h).

Engaging the outside mirrors



If an outside mirror has been forcibly disengaged forwards or backwards, proceed as follows.

- ▶ Press and hold button ① until you hear a click followed by the mirror audibly engaging in position.
The mirror housing will now be engaged and you will be able to adjust the outside mirrors as normal.

Heating the outside mirrors

Vehicles without a rear window heater: at temperatures below 59°F (15°C), the mirror heater will automatically switch on permanently once the engine has been started.

Vehicles with a rear window heater: at temperatures below 59°F (15°C), the mirror heater will automatically switch on for ten minutes once the engine has been started. The mirror heater can also be switched on together with the rear window heater.

- ▶ Switch on the ignition.
- ▶ Press the  button on the control panel for the air conditioning.
The indicator lamp on the  button lights up and the mirror heater switches on together with the rear window heater.

- ▶ **Glare from front:** fold sun visor ① downwards.
- ▶ **Glare from the side:** swivel sun visor ① to the side.

Dimming the inside rearview mirror

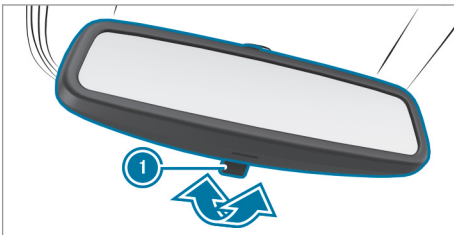

- ▶ Fold anti-glare lever ① in the direction of the arrow.



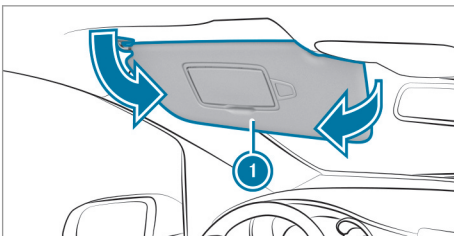



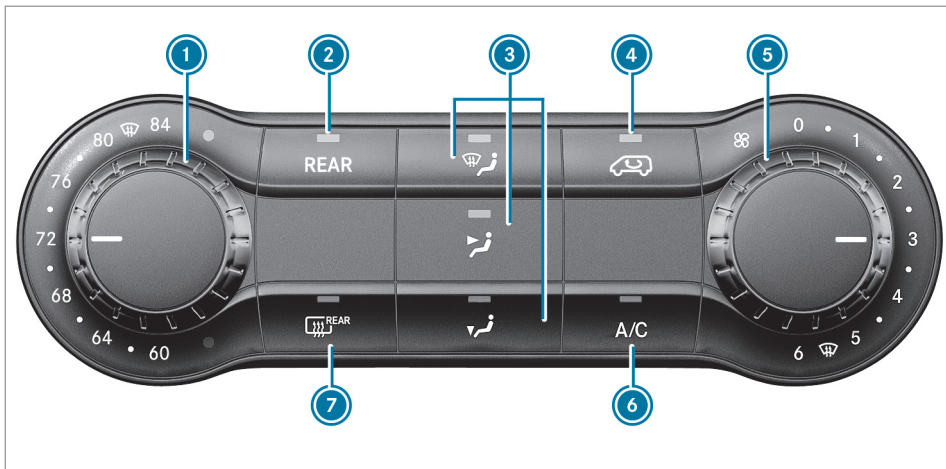

Operating sun visors



Overview of climate control systems

Overview of dual-zone automatic climate control



- ① Sets the temperature (→ page 93)
 Defrosts the windshield
- ②  Switches the rear air conditioning system on/off
- ③  Adjusts the air distribution (→ page 93)
 Defrosts the windshield
- ④  Switches air-recirculation mode on/off (→ page 94)
- ⑤  Sets the airflow (→ page 93)
 Defrosts the windshield
- ⑥  Switches cooling with air dehumidification on/off (→ page 92)
- ⑦  Switches the rear window heater and mirror heater on/off (→ page 95)

Overview of 3-zone automatic climate control

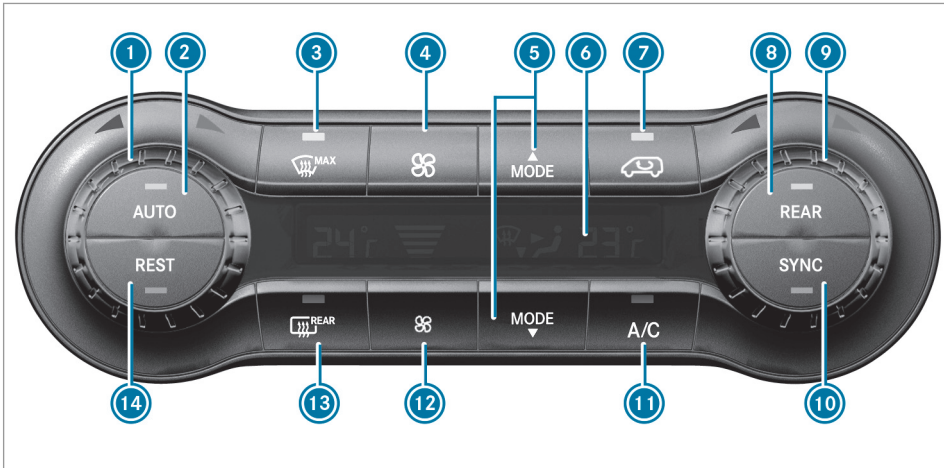

- 1 Sets the temperature on the left and at the rear (for vehicles with rear air conditioning system only) (→ page 93)
- 2 **AUTO** Switches on automatic mode (→ page 92)
- 3 **MAX** Defrosts the windshield (→ page 94)
- 4 **8** Increases airflow (→ page 93)
- 5 **MODE** Sets the air distribution (→ page 93)
- 6 Display
- 7 **↻** Switches air-recirculation mode on/off (→ page 94)
- 8 **REAR** Switches controls to rear air conditioning system (second menu level)
- 9 Sets the temperature on the right and at the rear (for vehicles with rear air conditioning system only) (→ page 93)
- 10 **SYNC** Switches synchronization on/off (→ page 94)
- 11 **A/C** Switches cooling with air dehumidification on/off (→ page 92)
- 12 **8** Reduces airflow (→ page 93)
- 13 **REAR** Switches the rear window heater and mirror heater on/off (→ page 95)
- 14 **REST** Switches residual heat utilization on/off (→ page 95)

Operating climate control systems

Switching the climate control system on/off

Front heating or dual-zone automatic climate control

If climate control is switched off, the air supply and circulation will also be switched off. Use this setting only for a brief period. Otherwise, the windows could fog up.

▶ Switch on the ignition.

▶ **To switch on:** turn the **8** airflow control to level **1** or higher.

▶ **To switch off:** turn the **8** airflow control to level **0**.

Front 3-zone automatic climate control

▶ Switch on the ignition.

▶ **To switch on:** press the **AUTO** button. The indicator lamp on the **AUTO** button will light up. Climate control will automatically be regulated according to the set temperature.

or

▶ Press the **8** button and set a blower setting.

The blower settings will be shown on the display as a bar graph.

▶ **To switch off:** press the **8** button and then press it again once the lowest blower setting has been reached.

The operating unit display will go off.

Rear dual-zone automatic climate control

- ▶ Switch on the dual-zone automatic climate control.
- ▶ **To switch on:** press the **REAR** button on the air conditioning operating unit.
The indicator lamp on the **REAR** button will light up when the rear climate control is switched on. The settings for temperature, airflow and, if a rear compartment air conditioning system is installed, air distribution will be adopted for the rear compartment climate control.

3-zone automatic climate control, rear compartment

- ▶ Switch on the 3-zone automatic climate control.

To switch on:

- ▶ Press the **REAR** button on the automatic climate control operating unit.
The indicator lamp on the **REAR** button will flash. The operating unit display will show the second menu level for the temperature and airflow setting of the rear air conditioning system.
- ▶ Press the **⊞** button and set a blower setting for the rear climate control.
The blower settings will be shown on the display as a bar graph. The rear air conditioning system will be switched on.
- ▶ If necessary, set the temperature for the rear climate control using the temperature control.
The display will show the selected rear compartment temperature.

If you do not set a new value within approximately ten seconds, the operating unit display will return to the first menu level for the automatic climate control settings. The indicator lamp on the **REAR** button will light up continuously.

- ⓘ The air distribution setting applies both to the automatic climate control and to the rear air conditioning system and cannot be set separately for the two.
- ▶ **To switch off:** press the **REAR** button on the automatic climate control operating unit.
The indicator lamp on the **REAR** button will flash. The operating unit display will show the second menu level for the temperature and airflow setting of the rear air conditioning system.

- ▶ Press the **⊞** button and then press it again once the lowest blower setting has been reached.
The operating unit display will go off and the rear air conditioning system will be switched off.

If you do not set a new value within approximately ten seconds, the operating unit display will return to the first menu level for the automatic climate control settings. The indicator lamp on the **REAR** button will go out.

- ⓘ When the vehicle is started, the climate control settings most recently selected will be adopted automatically.

Switching the A/C function on/off

Requirements

- The climate control system has been switched on (→ page 91).
- The engine is running.

When the "Cooling with air dehumidification" function is switched on, the air inside the vehicle is cooled and dehumidified according to the temperature selected.

For 3-zone automatic climate control, the function for automatic climate control settings can be activated or deactivated only on the first menu level. If you do not set a new value for the rear compartment climate control on the second menu level within approximately ten seconds, the control panel display will go back to the first menu level.

- ▶ Press the **A/C** button.
The indicator lamp on the **A/C** button will light up when the function is switched on.
- ⓘ Switch off the A/C function only briefly. Otherwise, the windows could fog up more quickly.
- ⓘ Condensation may leak from the underside of the vehicle in cooling mode. This is not a sign of a malfunction.

Automatically regulating climate control

Requirements:

- The climate control system has been switched on (→ page 91).

3-zone automatic climate control

When 3-zone automatic climate control is in automatic mode, the set temperature will automati-

cally be kept constant. The system automatically regulates the temperature of the dispensed air, the airflow and the air distribution.

Automatic mode for automatic climate control settings can be activated or deactivated only on the first menu level. If you do not set a new value for the rear-compartment climate control in the second menu level within approximately ten seconds, the control panel display will go back to the first menu level.

- ▶ Set the desired temperature (→ page 93).
- ▶ **To switch automatic mode on/off:** press the **AUTO** button.
When the indicator lamp on the **AUTO** button lights up, automatic mode is switched on. Airflow and air distribution are regulated automatically. The "defrost windshield" function is switched off.



If you deactivate automatic mode, the automatic climate control will save the current settings.

In automatic mode, if you adjust the airflow or air distribution manually, the indicator lamp above the **AUTO** button will go out. The function that has not been changed manually, however, will continue to be regulated automatically.







Information on the air distribution settings

In all air distribution settings, the side windows are supplied with air via the side air vents to prevent them from fogging up.

Heating or dual-zone automatic climate control

-  Directs air to the defroster vents
-  Directs air to the center and side air vents
-  Directs air to the footwell vents

3-zone automatic climate control



-  Directs air to the defroster vents
-  Directs air to the defroster, center and side air vents
-  Directs air to the defroster, center, side and footwell vents
-  Directs air to the defroster and footwell vents
-  Directs air to the center and side air vents
-  Directs air to the center, side and footwell vents
-  Directs air to the footwell vents

Setting the air distribution



Requirements:

- The climate control system is switched on.

Heating or dual-zone automatic climate control

- ▶ Press the ,  and/or  button. If the indicator lamp in a button lights up, the air is directed to the corresponding air vents.

3-zone automatic climate control

- ▶ Press the **MODE**  or **MODE**  button to set the air distribution. The control panel display shows the corresponding air distribution symbol.

Setting the airflow

Requirements:



- The climate control system is switched on.

Heating or dual-zone automatic climate control

- ▶ **To increase or decrease:** turn the airflow control clockwise or counter-clockwise to the desired level (→ page 90).

Vehicles with rear climate control: the set level will also be adopted for the rear compartment.

3-zone automatic climate control

- ▶ **To increase or decrease:** press the  or  button. The control panel display will show the airflow control setting as a bar graph.

Vehicles with rear climate control: press the **REAR** button to set the airflow for the rear compartment. When the indicator lamp on the button flashes, you can set the airflow.

Setting the temperature

Requirements

- The climate control system is switched on.

Heating or dual-zone automatic climate control

- ▶ **To increase or decrease:** turn the temperature control counter-clockwise or clockwise (→ page 90).

3-zone automatic climate control

You can set the temperature separately for the driver's and front passenger sides. In vehicles

with rear climate control, the temperature for the rear compartment can also be set. Each set temperature is automatically maintained at a constant level.

- ▶ **To increase or decrease:** turn the corresponding temperature control counter-clockwise or clockwise (→ page 91). The control panel display shows the set temperature for the left or right side at the respective edge of the display.

Vehicles with rear climate control: press the  button to set the temperature for the rear compartment. When the indicator lamp on the button flashes, you can set the temperature.



Switching the synchronization function on/off

Requirements:

- The climate control system has been switched on (→ page 91).

3-zone automatic climate control

The temperature can be set centrally using the synchronization function. The temperature setting for the driver's side will then be adopted for the front passenger side and, in vehicles with rear climate control, the rear compartment as well.

- ▶ Press the  button. When the indicator lamp on the  button lights up, the function is switched on. The display will then show the temperature set on the driver's side for the front passenger side.



The synchronization function will switch off if the temperature setting for the front passenger side or for the rear compartment is altered. The indicator lamp on the  button will go out.

Defrosting the windshield

Heating or dual-zone automatic climate control

You can use the following settings to defrost the windshield and remove condensation from the windshield and the front side windows from the inside. Select the following settings only for as long as it takes for the windshield to be clear.

- ▶ Switch on climate control (→ page 91).
- ▶ If necessary, switch on the rear window heater (→ page 95).
- ▶ If the windows are fogged up: switch off air-recirculation mode (→ page 94).

- ▶ Turn the temperature control and airflow control to the  position (→ page 90).
- ▶ Select the  position for air distribution (→ page 93). Only the indicator lamp on the  button will light up.
- ▶ Vehicles with heating: close the center air vent (→ page 95).
- ▶ Vehicles with air conditioning: switch on the "Cooling with air dehumidification" function (→ page 92).

3-zone automatic climate control

You can use the following settings to defrost the windshield and remove condensation from the windshield and the front side windows from the inside. Select the following settings only for as long as it takes for the windshield to be clear.

- ▶ Switch on climate control (→ page 91).
- ▶ If necessary, switch on the rear window heater (→ page 95).
- ▶ Press the  button. The temperature, airflow and air distribution will be regulated automatically. Air-recirculation mode will be deactivated.

When you enable automatic mode, the "Defrost windshield" function will switch off automatically.

When you switch off the "Defrost windshield" function, the previous settings for automatic climate control will be applied again.



Note the following exceptions:

- Air-recirculation mode will remain switched off.
- If the A/C function has been automatically activated, it will remain active.

Switching air-recirculation mode on/off

Dual-zone or 3-zone automatic climate control

When air-recirculation mode is switched on, the windows may fog up more quickly. Switch on air-recirculation mode only briefly.

- ▶ Press the  button. When the indicator lamp on the  button lights up, air-recirculation mode is switched on.

Air-recirculation mode will automatically switch on in the following cases:

- At high outside temperatures
- While the vehicle is driving through a tunnel (vehicles with 3-zone automatic climate control and navigation only)

After approximately 30 minutes, outside air will automatically be introduced again.

Air-recirculation mode will automatically switch off in the following cases:

- After approximately five minutes at outside temperatures below approximately 44°F (7°C)
- After approximately five minutes when the "Cooling with air dehumidification" function is deactivated
- After approximately 30 minutes at outside temperatures above approximately 44°F (7°C) and when the "Cooling with air dehumidification" function is switched on

Convenience opening/closing

⚠ WARNING Risk of becoming trapped during convenience opening

During convenience opening, body parts could be drawn in or become trapped between the side window and the door frame.

- ▶ When opening, make sure that nobody touches the side window.
- ▶ Release the  button immediately to interrupt the opening procedure if somebody becomes trapped.



▶ **Pre-entry climate control and convenience opening with the key:** press and hold the  button on the key. The side windows open automatically and the blower of the climate control system is activated.

ⓘ At higher interior temperatures, the blower is also activated when a door is opened. This means that cooled air enters the vehicle interior sooner to cool the vehicle more rapidly.

Switching the rear window heater on/off

The rear window heater consumes a lot of electricity. You should therefore switch off the rear

window heater as soon as the rear window is clear.





- ▶ Switch on the ignition.
- ▶ Press the  button on the control panel. If the indicator lamp on the  button lights up, the rear window heater is switched on.

The rear window heater switches off automatically after a few minutes.

Switching the residual heat utilization on/off

Only vehicles with 3-zone automatic climate control have the residual heat function.

When the engine is switched off, it is possible to make use of the residual heat of the engine to heat or ventilate the vehicle interior for approximately 30 minutes. The heating or ventilation time depends on the set vehicle interior temperature.

- ▶ Switch off the engine or remove the key.
- ▶ **To switch on:** press the  button. When residual heat utilization is switched on, the indicator lamp on the  button will light up. The blower will run at a low speed regardless of the airflow setting. If the "Residual heat" function is switched on at high outside temperatures, only the stationary ventilation will be switched on. The blower will then run at medium speed.
- ▶ **To switch off:** press the  button again. The indicator lamp on the  button will go out.

Residual heat utilization will switch off automatically in the following cases:

- After a running time of approximately 30 minutes
- If the starter battery's condition of charge is too low
- When the ignition is switched on

Operating air vents

Adjusting the air vents

⚠ WARNING Risk of burns and frostbite due to being too close to the air vents

Very hot or very cold air can flow from the air vents.

- ▶ Make sure that all vehicle occupants always maintain a sufficient distance from the air vents.
- ▶ If necessary, direct the airflow to another area of the vehicle interior.

Adjusting the center air vents

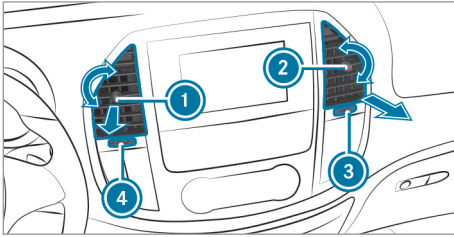

- ▶ **To open/close:** turn controller ① or ② to the right or left as far as it will go.

Adjusting the airflow direction:

- ▶ Hold the center air vent by controller ① or ② and move it up or down.
- ▶ Using adjustment wheel ③ or ④, move the center air vent to the left or right.

Adjusting the side air vents:

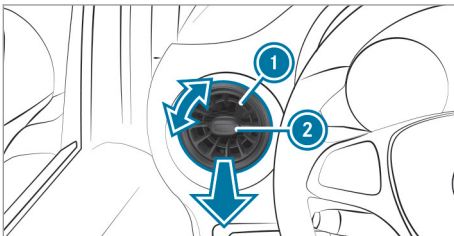

- ▶ **To open/close:** turn controller ② clockwise or counter-clockwise as far as it will go.
- ▶ **To adjust the airflow direction:** hold side air vent ① by controller ② and move it up or down or to the left or right.

Opening/closing the rear air vents:

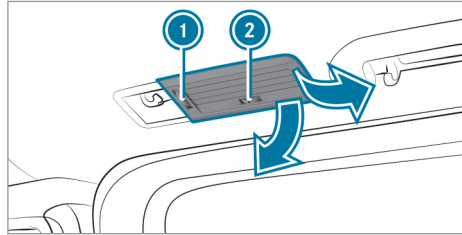

- ① Adjustment wheel for vertically adjusting and regulating airflow
- ② Adjustment wheel for horizontally adjusting airflow

The rear air vents can be adjusted only on vehicles with a rear air conditioning system.

Vehicles with a rear air conditioning system: in heating mode, the air in the rear passenger compartment is automatically distributed in the footwells and roof area once the coolant has reached the required temperature. In cooling mode, the air is distributed in the footwells and roof area of the hot vehicle in the initial phase, and subsequently only in the roof area.

- ▶ **To open:** turn adjustment wheel ① of the rear air vent to the center position.
- ▶ **To close:** turn adjustment wheel ① to the upper or lower end position.

Driving

Key positions

⚠ WARNING Risk of accident and injury due to children left unattended in the vehicle

If children are left unsupervised in the vehicle, they could, in particular:

- open doors, thereby endangering other persons or road users.
- get out and be struck by oncoming traffic.
- operate vehicle equipment and become trapped, for example.

In addition, the children could also set the vehicle in motion, for example by:

- releasing the parking brake.
- changing the transmission position.
- starting the vehicle.

- ▶ Never leave children unattended in the vehicle.
- ▶ When leaving the vehicle, always take the SmartKey with you and lock the vehicle.
- ▶ Keep the vehicle SmartKey out of reach of children.

⚠ DANGER Risk of death caused by exhaust gases

Combustion engines emit poisonous exhaust gases such as carbon monoxide. Inhaling these exhaust gases is hazardous to health and leads to poisoning.

- ▶ Never leave the engine or, if present, the auxiliary heating running in an enclosed space without sufficient ventilation.

⚠ WARNING Risk of fire due to flammable material in the engine compartment or the exhaust system

Flammable materials may ignite.

- ▶ Therefore, check regularly that there are no flammable materials in the engine compartment or on the exhaust system.

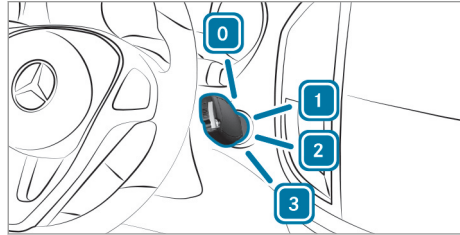

- 0** To insert/remove the key
- 1** To switch on the power supply
- 2** To switch on the ignition
- 3** To start the engine

i If the key does not belong to the vehicle, it can still be turned in the ignition lock. However, the ignition will not be switched on. The engine cannot be started.

- ▶ Insert the key into the ignition lock in position **0** and turn it to the desired position.

Breaking-in notes

Protect the engine during the first 1,000 miles (1,500 km) by:

- Driving at varying road and engine speeds.
- Shifting to the next gear up when or before the tachometer needle is $\frac{2}{3}$ of the way to the red area.
- Avoiding stress on the vehicle such as driving at full throttle.
- Not shifting manually to a lower gear to brake.
- After 1,000 miles (1,500 km), gradually increasing the engine speed and accelerating the vehicle up to full speed.
- Not depressing the accelerator pedal past the pressure point (kickdown).

This also applies if the engine or parts of the drivetrain have been replaced.

Also observe the following breaking-in notes:

- After the vehicle has been delivered or after repairs, the sensor system of certain driving systems and certain driving safety systems adjust themselves automatically after the vehicle has been driven a certain distance. Full system effectiveness is not reached until the end of this teach-in process.
- New and replaced brakepads, brake disks and tires only reach their optimal braking effect

and traction after approximately 100 miles. Until then, compensate for the reduced braking effect by applying greater pressure to the brake pedal.

Driving tips

Notes on driving

⚠ WARNING Risk of accident due to objects in the driver's footwell

Objects in the driver's footwell may impede pedal travel or block a depressed pedal.

This jeopardizes the operating and road safety of the vehicle.

- ▶ Stow all objects securely in the vehicle so that they do not get into the driver's footwell.
- ▶ When using floor mats or carpets, make sure that they are properly secured so that they do not slip or obstruct the pedals.
- ▶ Do not lay multiple floor mats or carpets on top of one another.

⚠ WARNING Risk of accident due to incorrect footwear

Incorrect footwear includes, for example:

- Shoes with platform soles
- Shoes with high heels
- Slippers

- ▶ Always wear suitable footwear so that you can operate the pedals safely.

⚠ WARNING Risk of accident if the ignition is switched off while driving

If you switch off the ignition while driving, safety functions are restricted or no longer available.

You will need to use considerably more force to steer and brake, for example.

- ▶ Do not switch off the ignition while driving.

⚠ DANGER Risk of death caused by exhaust gases

Combustion engines emit poisonous exhaust gases such as carbon monoxide. Inhaling

these exhaust gases is hazardous to health and leads to poisoning.

- ▶ Never leave the engine or, if present, the auxiliary heating running in an enclosed space without sufficient ventilation.

⚠ WARNING Risk of skidding and of an accident due to shifting down on slippery road surfaces

If you shift down on slippery road surfaces to increase the engine braking effect, the drive wheels may lose traction.

- ▶ Do not shift down on slippery road surfaces to increase the engine braking effect.

⚠ DANGER Risk of fatal injury due to poisonous exhaust gases

If the tailpipe is blocked or sufficient ventilation is not possible, poisonous exhaust gases such as carbon monoxide may enter the vehicle. This is the case when the vehicle becomes stuck in snow, for example.

- ▶ Keep the tailpipe and the area around the vehicle free from snow when the engine or the stationary heater are running.
- ▶ Open a window on the side of the vehicle facing away from the wind to ensure an adequate supply of fresh air.

⚠ WARNING Risk of accident and injury due to being under the influence of alcohol and drugs while driving

Drinking and driving and/or taking drugs and driving are very dangerous combinations. Even a small amount of alcohol or drugs can affect your reflexes, perceptions and judgment.

The possibility of a serious or even fatal accident are greatly increased when you drink or take drugs and drive.

- ▶ Do not drink or take drugs and drive or allow anyone to drive who has been drinking or taking drugs.

⚠ WARNING Risk of accident and injury from operating mobile communications equipment

If you operate mobile communication equipment when driving, you will be distracted from the traffic situation. This could also cause you to lose control of the vehicle.

The probability of a serious or even fatal accident increases greatly if you operate mobile communication equipment when driving.

- ▶ Only operate mobile communication equipment when the vehicle is stationary.

For your own safety, always observe the following points when operating mobile communications equipment:

- Observe the legal requirements for the country in which you are driving.
- While driving, only operate mobile communications equipment when the traffic conditions permit it. You may otherwise be distracted from the traffic conditions and cause an accident, injuring yourself and others.

! NOTE Damage to the drivetrain and engine when pulling away

- ▶ Do not warm up the engine while the vehicle is stationary. Pull away immediately.
- ▶ Avoid high engine speeds and driving at full throttle until the engine has reached its operating temperature.

Exhaust emission monitoring

Specific engine systems are designed to keep poisonous components of exhaust gases within legal limits.

These systems only work optimally if they are maintained exactly according to manufacturer's specifications. It is for this reason that all work on the engine should only be performed by qualified and authorized Mercedes-Benz Commercial Van Center technicians.

Under no circumstances should engine settings be changed. In addition, all specific maintenance work must be performed at regular intervals and in compliance with the service regulations of the dealer named in the imprint. Refer to the Maintenance Booklet for details.

Notes on the limit speed

⚠ WARNING Risk of injury through exceeding the specified tire load-bearing capacity or the permissible speed rating

Exceeding the specified tire load rating or the permissible speed rating may lead to tire damage and to the tires bursting.

- ▶ Therefore, only use tire types and sizes approved for your vehicle model.
- ▶ Observe the tire load rating and speed rating required for your vehicle.

As the driver, you must find out about the maximum permissible speed for the tires (tire and tire pressure). Observe the legal requirements for tires for the country in which you are staying. You can permanently limit the speed of your vehicle.

Mercedes-Benz recommends a qualified specialist workshop for programming the limit speed.

Note that you cannot exceed a programmed limit speed when overtaking.

On downhill gradients, the limit speed may be exceeded. Apply the brakes if necessary.

Display messages indicate that you are approaching the limit speed.

Information about driving abroad

Service

An extensive Mercedes-Benz service is also available abroad. Nevertheless, please remember that services or spare parts may not be available immediately. The relevant workshop directories are available from a Mercedes-Benz Commercial Van Center.

Fuel

In some countries, only fuels with an increased sulfur content are available.

Unsuitable fuel can cause engine damage. You can find further information under "Fuel" (→ page 228).

Information about transport by rail

Transporting your vehicle by rail may be subject to certain restrictions or require special measures to be taken in some countries due to varying tunnel heights and loading standards.

You can obtain information about this from a Mercedes-Benz Commercial Van Center.

Information on brakes

⚠ WARNING Risk of accident due to the brake system overheating

If you leave your foot on the brake pedal when driving, the brake system may overheat.

This increases the braking distance and the brake system may even fail.

- ▶ Never use the brake pedal as a footrest.
- ▶ Do not depress the brake pedal and the accelerator pedal at the same time while driving.

! NOTE Wearing out the brake linings by continuously depressing the brake pedal

- ▶ Do not depress the brake pedal continuously whilst driving.
- ▶ To use the braking effect of the engine, shift to a lower gear in good time.

Downhill gradients

On long and steep downhill gradients you should observe the following instructions:

- in vehicles with an automatic transmission, shift down to shift ranges **2** or **1** in good time so that the engine is running at a medium to high engine speed (→ page 106).
- ⓘ Change the shift range in good time when cruise control is activated. Observe the driving tips (→ page 98).

You thereby make use of the braking effect of the engine and do not have to brake as often to maintain the speed. This relieves the load on the service brake and prevents the brakes from overheating and wearing too quickly.

Heavy and light loads

If the brakes have been subjected to a heavy load, do not stop the vehicle immediately. Drive on for a short while. The brakes cool down more quickly in the airflow.

If the brakes have been used only moderately, you should occasionally test their effectiveness. To do this, brake more firmly from a higher speed while paying attention to the traffic conditions. The brakes will grip better as a result.

Wet road surfaces

If you have been driving for a long time in heavy rain without braking, there may be a delayed response when you first apply the brakes. This

may also occur after driving through a car wash or deep water. You must depress the brake pedal more firmly. Maintain a greater distance to the vehicle in front.

While paying attention to the traffic conditions, you should brake the vehicle firmly after driving on a wet road surface or through a car wash. This heats the brake discs so that they dry more quickly, which protects them against corrosion.

Limited braking effect on salt-treated roads:

- a layer of salt on the brake discs or brakepads can increase braking distances considerably, or braking may happen on only one side
- maintain an especially large safe distance to the vehicle in front

To remove the layer of salt:

- apply the brakes from time to time, paying attention to traffic conditions
- carefully depress the brake pedal at the end of a journey and after the start of a new journey

Checking the brakepad thickness

In addition to monitoring using the brakepad wear sensor, regularly monitor and check all of the brakepads by performing a visual inspection to look for material wear on the pads.

If you are unable to check the brakepad wear on the inside of the wheels, remove the wheels if you possess the required skills, or visit a qualified specialist workshop.

If the brakepad material thickness is less than 0.12 in (3 mm), have the brakepads checked and replaced at a qualified specialist workshop, if necessary.

Do not solely rely on the brakepad wear sensor.

It is also strongly recommended that you have the brakepads checked at a qualified specialist workshop, not only at every service displayed by the maintenance interval display, but also prior to long journeys and whenever the wheels are removed.

Check the brakepads in the following cases:

- At every service according to the maintenance interval
- Before long journeys
- At every tire change
- Regular visual inspection for your own safety

New brake discs and brakepads

New brakepads and brake discs only reach their optimal braking effect after a few hundred miles (a few hundred kilometers).

Until then, compensate for the reduced braking effect by applying greater pressure to the brake pedal. For safety reasons, Mercedes-Benz recommends that you only have brakepads and brake discs which are approved by Mercedes-Benz installed on your vehicle.

Other brake discs or brakepads may compromise the safety of your vehicle.

Always replace all brake discs and brakepads on an axle at the same time. Always install new brakepads when replacing brake discs.

Parking brake

▲ WARNING Risk of skidding or an accident by braking with the parking brake

If you have to brake your vehicle with the parking brake, the braking distance is considerably longer and the wheels may lock. There is an increased risk of skidding and/or accident.

- ▶ Only brake the vehicle with the parking brake if the service brake has failed.
- ▶ In this case, do not apply the parking brake with too much force.
- ▶ If the wheels lock, immediately release the parking brake as much as required for the wheels to turn again.

When driving on wet roads or dirt-covered surfaces, road salt or dirt may get into the parking brake. This causes corrosion and a reduction of braking force.

In order to prevent this, drive with the parking brake lightly applied from time to time.

When doing so, drive for a distance of approximately 300 ft at a maximum speed of 13 mph (20 km/h).

The brake lights do not light up when you brake the vehicle with the parking brake.

Information about driving on wet roads

Notes on hydroplaning

Hydroplaning can occur on the road surface above a certain water level.

Observe the following notes in the event of heavy rainfall or conditions in which hydroplaning may occur:

- Reduce your speed
- Avoid tire ruts
- Avoid sudden steering movements
- Brake carefully

Notes on crossing water on the roads

Water entering the vehicle can damage the drive system, the electrical system and the transmission.

If you have to drive through water, observe the following notes:

- The water level of standing water may not be above the lower edge of the front bumper.
- You may drive no faster than walking pace.
- Vehicles driving in front or approaching from the opposite direction can create waves, which can cause the maximum permissible water level to be exceeded.

After passing through water, the brakes have a reduced braking effect. Brake the vehicle carefully, taking into account the traffic situation, until the full braking effect is restored.

Information about driving in winter

Vehicles with automatic transmissions may roll in neutral position **[N]** for only a short time. Allowing the wheels to roll for longer, e.g. when towing, causes transmission damage.

If the vehicle threatens to skid, or cannot be stopped when traveling at a low speed, you can stabilize the vehicle using the following measures:

- Shift the automatic transmission to neutral position **[N]**.
- Try to maintain control of the vehicle using corrective steering.

Drive particularly carefully on slippery roads. Avoid sudden acceleration, steering and braking maneuvers.

Have your vehicle winterized at a qualified specialist workshop in good time at the onset of winter.

Observe the notes on snow chains (→ page 205).

Regularly check the vehicle and remove snow or ice when traveling in wintry conditions.

An accumulation of snow and ice, particularly when frozen, in the area around the air intake, moving parts, the axles, and the wheel wells may cause the following problems:

- Obstruction of the air intake
- Damage to vehicle parts
- Malfunctions due to restriction of the mobility intended by the design (e.g. reduced steering movement)

If there is any damage, inform a qualified specialist workshop.

Information about driving off-road

⚠ WARNING Risk of accident if you do not keep to line of fall on inclines

If you drive at an angle or turn on an incline, the vehicle could slip sideways, tip and roll-over.

- ▶ Always drive on inclines in the line of fall (straight up or down) and do not turn.

⚠ WARNING Risk of injury from acceleration forces during off-road driving

You could be thrown from your seat, for example.

- ▶ Always wear your seat belt even when driving off-road.

⚠ WARNING Risk of injury to the hands when driving over obstacles

If you drive over obstacles or in tire ruts, the steering wheel may whip around.

- ▶ The steering wheel must always be held securely with both hands.
- ▶ Always hold the steering wheel so that your thumbs are on the outer rim of the steering wheel.
- ▶ When driving over obstacles, expect increased steering forces at short notice.

⚠ WARNING Risk of fire due to flammable materials on hot parts of the exhaust system

Flammable material such as leaves, grass or twigs may ignite if they come into contact with hot parts of the exhaust system.

- ▶ When driving on unpaved roads or off-road, regularly check the vehicle underside.
- ▶ Remove trapped plants or other flammable material, in particular.
- ▶ If there is damage, consult a qualified specialist workshop immediately.

! NOTE Damage to the vehicle after driving off-road

Foreign bodies, such as stones and branches, could become trapped on the vehicle underside or on wheels and tires while you are driving and cause damage to the vehicle.

Foreign bodies could cause the following damage:

- Damage the suspension, the fuel tank or the brake system
- Cause imbalances and thus vibrations
- ▶ Regularly remove any trapped foreign bodies, e.g. stones and branches.
- ▶ After driving off-road, check carefully whether there is any damage to the vehicle.
- ▶ If there is damage, have the vehicle checked at a qualified specialist workshop.

When driving off-road or on unpaved surfaces, check the vehicle underside, wheels and tires regularly at regular intervals. In particular, remove any trapped foreign bodies, e.g. stones and branches.

Observe the following notes regarding foreign bodies of this kind:

- They may damage the suspension, the fuel tank or the brake system.
- They may disturb the balance and cause vibrations.
- They may be flung out from the vehicle when you continue driving.

If there is any damage, inform a qualified specialist workshop.

When driving off-road and on construction sites, sand, mud and water, also mixed with oil, can get into the brakes. This may lead to a reduction in braking effect or total brake failure, also as a result of increased wear. The braking characteristics will vary depending on the material that has

got into the system. Clean the brakes after driving off-road. If you then notice a reduced braking effect or hear scraping noises, have the brake system checked immediately at a qualified specialist workshop. Adjust your driving style to the changed braking characteristics.

Driving off-road or on construction sites increases the possibility of vehicle damage which may in turn lead to the failure of certain major assemblies and systems. Adapt your driving style to the off-road driving conditions. Drive carefully. Have any vehicle damage rectified at a qualified specialist workshop as soon as possible.

When driving on rough cross-country terrain, do not shift the transmission to neutral and do not disengage the clutch. You could lose control when attempting to brake the vehicle with the service brake. If your vehicle cannot manage an uphill incline, drive back down in reverse gear.

When loading your vehicle for off-road driving or on a construction site, keep the vehicle's center of gravity as low as possible.

Checklist before off-road driving

- **Engine:** check the oil level and add oil if necessary (→ page 179). Before driving up or down extreme inclines or slopes, fill the oil to the maximum level.
- **Information:** If you drive up or down extreme inclines or slopes, the  symbol may appear in the multifunction display. The engine operating safety is not put at risk if you have filled the engine oil to the maximum level before the journey.
- **Vehicle tool kit:** check that the jack is working (→ page 201).
- Make sure that a lug wrench, a wooden underlay for the jack, a robust tow rope, a folding spade and a wheel chock (depending on equipment) are carried in the vehicle (→ page 201).
- **Tires and wheels:** check the tire tread depth (→ page 204) and the tire pressure (→ page 209).

Rules for off-road driving

Always be aware of the ground clearance of the vehicle and avoid obstacles such as deep tire ruts.

Obstacles can damage the following parts of the vehicle, for example:

- Suspension
- Drivetrain
- Fuel and supply tanks

Therefore, always drive slowly when off-road. If you must drive over obstacles, have the co-driver instruct you.

- **Information:** Mercedes-Benz recommends that you additionally carry a shovel and a recovery rope with a shackle in the vehicle.
- Make sure that loads and items of luggage are securely stored or lashed down (→ page 166).
- Before driving off-road, stop the vehicle and engage a low gear.
- If the surface requires, temporarily deactivate ESP® when pulling away (→ page 111).
- Only drive off-road with the engine running and a gear engaged.
- Drive slowly and smoothly. It may often be necessary to drive at walking pace.
- Avoid spinning the driven wheels.
- Always ensure that the wheels remain in contact with the ground.
- Exercise the utmost caution when driving across unfamiliar, unpredictable terrain. As a precaution, get out of the vehicle to take a look at the route to be taken first.
- Look out for obstacles (e.g. rocks, holes, tree stumps and tire ruts).
- Avoid edges where the surface could crumble or break away.

Checklist after driving off-road

Driving over rough terrain places greater demands on your vehicle than normal road operation. Check your vehicle after driving on rough terrain. This allows you to detect damage promptly and reduce the risk of an accident for yourself and other road users. Clean your vehicle thoroughly before driving on public roads.

If you find damage to the vehicle after off-road driving, have the vehicle checked at a qualified specialist workshop immediately.

Observe the following points after driving off-road, on construction sites and before driving on public roads:

- Activate ESP® (→ page 111).
- Clean the exterior lighting, particularly the headlamps and tail lamps, and check them for damage.
- Clean the front and rear license plates.
- Clean the windshield, windows and outside mirrors.
- Clean the steps, entrances and grab handles. This increases the safety of your footing.
- Clean the wheels and tires, wheel wells and the underbody of the vehicle with a water jet. This increases road adhesion, especially on wet roadways.
- Check the wheels and tires and wheel wells for trapped foreign objects and remove them. Trapped foreign objects can damage the wheels and tires or may be flung out from the vehicle when continuing the journey.
- Check the underbody for trapped branches or other parts of plants and remove them.
- Clean the brake discs, brakepads and axle joints, particularly after operation in sand, mud, grit and gravel, water or similarly dirty conditions.
- Check the entire floor assembly, the tires, wheels, bodywork structure, brakes, steering, suspension and exhaust system for any damage.
- Check the service brake for operating safety, e.g. carry out a brake test.
- If you notice strong vibrations after driving off-road, check the wheels and drivetrain for foreign objects again. Remove any foreign objects which can lead to imbalances and thus cause vibrations. In the event of damage to the wheels and the drive train, visit a qualified specialist workshop immediately.

Notes on driving in mountainous areas

When driving in mountainous areas, note that engine output, and therefore start-off gradeability, will decrease with increasing elevation. Observe the notes on braking on downhill gradients (→ page 100).

The maximum permissible trailer loads are valid for journeys at elevations up to 1,100 yds (1,000 m) above sea level with gradients up to 12% (→ page 233).

Automatic transmission

DIRECT SELECT lever

Function of the DIRECT SELECT lever

⚠ WARNING Risk of accident and injury due to children left unattended in the vehicle

If children are left unsupervised in the vehicle, they could, in particular:

- Open doors, thereby endangering other persons or road users.
- Get out and be struck by oncoming traffic.
- Operate vehicle equipment and become trapped, for example.

In addition, the children could also set the vehicle in motion, for example by:

- Releasing the parking brake.
- Changing the transmission position.
- Starting the vehicle.

- ▶ Never leave children unattended in the vehicle.
- ▶ When leaving the vehicle, always take the SmartKey with you and lock the vehicle.
- ▶ Keep the vehicle SmartKey out of reach of children.

⚠ WARNING Risk of accident due to incorrect gearshifting

If the engine speed is higher than the idle speed and you engage the transmission position **[D]** or **[R]**, the vehicle may accelerate sharply.

- ▶ If you engage the transmission position **[D]** or **[R]** when the vehicle is at a standstill, always depress the brake pedal firmly and do not accelerate at the same time.

! NOTE Transmission damage due to shifting at high engine speed or when the vehicle is rolling

You can damage the automatic transmission if you shift from **[D]** to **[R]**, from **[R]** to **[D]** or directly to **[P]** when the engine speed is too high or the vehicle is rolling.

- ▶ Only change the transmission position when the vehicle is stationary.

You use the DIRECT SELECT lever to switch the transmission position. The current transmission position appears in the multifunction display (→ page 140).

The shifting characteristics of the automatic transmission is designed for comfortable and economical driving. For this reason, the multifunction display shows, in addition to the transmission position display, the **C** for Comfort.

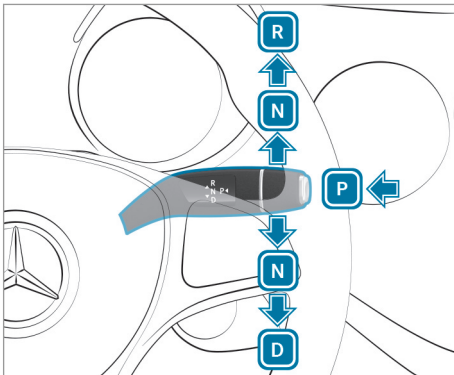

- P** Park position
- R** Reverse gear
- N** Neutral
- D** Drive position

Engaging reverse gear R

- ▶ Depress the brake pedal and push the DIRECT SELECT lever upwards past the first point of resistance.

Selecting neutral N

⚠ WARNING Risk of accident and injury when neutral position is engaged

If you park the vehicle with the transmission in neutral position **N** and the parking brake is not engaged, the vehicle may roll away.

There is a risk of accident and injury.

- ▶ Before parking the vehicle, apply the parking brake.

- ▶ Press the brake pedal and the DIRECT SELECT lever upwards or downwards to the first point of resistance.

Releasing the brake pedal will allow you to move the vehicle freely, for example, to push it or tow it.

If the automatic transmission should also stay in neutral **N** when the ignition is switched off, proceed as follows:

- ▶ Start the vehicle.
- ▶ Depress the brake pedal and engage neutral **N**.
- ▶ Release the brake pedal.
- ▶ Switch off the ignition and leave the key in the ignition lock.

Engaging park position P

- ▶ Press the **P** button on the DIRECT SELECT lever when the vehicle is stationary.

Park position **P** is engaged automatically when one of the following conditions is met:

- you switch off the engine in transmission position **D** or **R**.
- if you remove the key from the ignition lock.
- you open the driver's door when the vehicle is stationary or when driving at a very low speed and in transmission position **D** or **R**.

Engaging drive position D

- ▶ Depress the brake pedal and push the DIRECT SELECT lever downwards past the first point of resistance.

The automatic transmission shifts through the individual gears automatically when it is in transmission position **D**. This is determined by the following factors:

- shift range is limited (→ page 106)
- position of the accelerator pedal
- driving speed

Restricting the shift range

Requirements:

- Transmission position **D** is engaged (→ page 105).

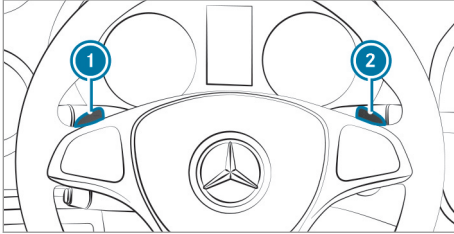

- ▶ **To restrict the shift range:** briefly pull steering wheel gearshift paddle **1**.

The automatic transmission shifts to the next lower gear, depending on the gear currently engaged. The shift range is also restricted.

The shift range selected is shown in the multifunction display. The automatic transmission shifts only as far as the selected gear.

- ▶ Pull and hold steering wheel gearshift paddle **1**.

The automatic transmission will change to a shift range which allows easy acceleration and deceleration. To do this, the automatic transmission shifts down one or more gears and restricts the shift range.

The shift range selected is shown in the multifunction display. The automatic transmission shifts only as far as the selected gear.

- ⓘ The automatic transmission does not shift down if you pull steering wheel gearshift paddle **1** whilst traveling at too high a speed. If the maximum engine speed for the restricted shift range is reached and you continue to depress the accelerator pedal, the automatic transmission will shift up automatically. This protects against engine overrev.

- ▶ **To de-restrict the shift range:** briefly pull steering wheel gearshift paddle **2**.

The automatic transmission shifts to the next gear up, depending on the gear currently engaged. This de-restricts the shift range at the same time.

The shift range selected is shown in the multifunction display. The automatic transmission shifts only as far as the selected gear.

- ▶ **To de-restrict the shift range:** pull and hold steering wheel gearshift paddle **2**.

or

- ▶ Engage transmission position **D** again (→ page 105).

The automatic transmission shifts up one or more gears depending on the gear currently engaged. Simultaneously, the shift range restriction is deactivated and the transmission position appears in the multifunction display **D**.

Recommended shift ranges for the following driving conditions:

- 3 Use the engine's braking effect.
- 2 Use the engine's braking effect on downhill gradients and when driving on steep roads, in mountainous areas as well as under arduous operating conditions.
- 1 Use the engine's braking effect on extremely steep downhill gradients and on long downhill stretches.

Using kickdown

- ▶ **For maximum acceleration:** depress the accelerator pedal beyond the pressure point.

Refueling

Refueling the vehicle

- ⚠ **WARNING** Risk of fire or explosion from fuel

Fuels are highly flammable.

- ▶ Fire, open flames, smoking and creation of sparks must be avoided.
- ▶ Switch off the ignition and, if available, the stationary heater, before and while refueling the vehicle.

- ⚠ **WARNING** Risk of injury from fuels

Fuels are poisonous and hazardous to your health.

- ▶ Do not swallow fuel or let it come into contact with skin, eyes or clothing.
- ▶ Do not inhale fuel vapor.
- ▶ Keep children away from fuel.
- ▶ Keep doors and windows closed during the refueling process.

If you or other people come into contact with fuel, observe the following:

- ▶ Immediately rinse fuel off your skin with soap and water.
- ▶ If fuel comes into contact with your eyes, immediately rinse them thoroughly with clean water. Seek medical attention immediately.
- ▶ If you swallow fuel, seek medical attention immediately. Do not induce vomiting.
- ▶ Change immediately out of clothing that has come into contact with fuel.

⚠ WARNING Risk of fire and explosion due to electrostatic charge

Electrostatic charge can ignite fuel vapor.

- ▶ Before you open the fuel filler cap or take hold of the pump nozzle, touch the metallic vehicle body.
- ▶ To avoid creating another electrostatic charge, do not get into the vehicle again during the refueling process.

! NOTE Do not use diesel to refuel vehicles with a gasoline engine

If you have accidentally refueled with the wrong fuel:

- Do not switch the ignition on. Otherwise fuel can enter the engine.
Even small amounts of the wrong fuel could result in damage to the fuel system and the engine. The repair costs are high.
- ▶ Consult a qualified specialist workshop.
- ▶ Have the fuel tank and fuel lines drained completely.

! NOTE Damage to the fuel system caused by overfilled fuel tanks

- ▶ Only fill the fuel tank until the pump nozzle switches off.

Requirements:

- The vehicle is unlocked.
- The ignition is switched off.
- The front left-hand door is open.

- ⓘ Do not get back into the vehicle during the refueling process. Otherwise, electrostatic charge could build up again.

Observe the notes on operating fluids (→ page 227).

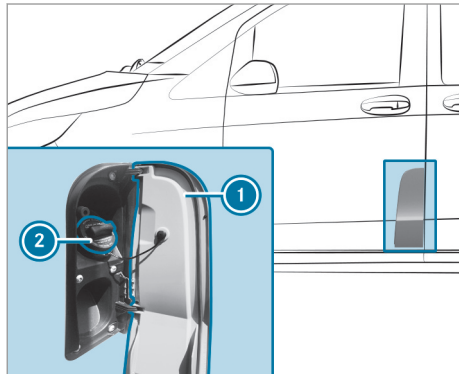

- ▶ Open fuel filler flap ① .
- ▶ Turn fuel filler cap ② counter-clockwise and remove it.
- ▶ Close all vehicle doors to prevent fuel vapors from entering the vehicle interior.
- ▶ Completely slide the filler neck of the pump nozzle into the tank, hook in place and refuel.
- ▶ Fill the fuel tank only until the pump nozzle switches off.
- ▶ Replace fuel filler cap ② and turn it clockwise. You will hear a click when the fuel filler cap is closed fully.
- ▶ Open the front left-hand door.
- ▶ Close fuel filler flap ① .

- ⓘ If the fuel tank has been run completely dry, add at least 1.3 gal (5 l) of fuel. Before starting the engine again, switch on the ignition three or four times.

- ⓘ Vehicles that can use a mixture of fuels can be recognized by the sticker "Ethanol up to E85!" on the fuel filler flap.

Problems with the fuel and fuel tank

Problem	Possible causes/consequences and Solutions
Fuel is leaking from the vehicle.	<p>The fuel line or the fuel tank is faulty.</p> <ul style="list-style-type: none"> ▶ Turn the key to position 0 in the ignition lock immediately and remove it. ▶ Do not restart the engine under any circumstances. ▶ Consult a qualified specialist workshop.

Parking
Parking the vehicle

⚠ WARNING Risk of fire caused by hot exhaust system parts

Flammable materials such as leaves, grass or twigs may ignite.

- ▶ Park the vehicle so that no flammable material can come into contact with hot vehicle components.
- ▶ In particular, do not park on dry grass-land or harvested grain fields.

⚠ WARNING Risk of accident and injury due to children left unattended in the vehicle

If children are left unsupervised in the vehicle, they could, in particular:

- Open doors, thereby endangering other persons or road users.
- Get out and be struck by oncoming traffic.
- Operate vehicle equipment and become trapped, for example.

In addition, the children could also set the vehicle in motion, for example by:

- Releasing the parking brake.
- Changing the transmission position.
- Starting the vehicle.

- ▶ Never leave children unattended in the vehicle.
- ▶ When leaving the vehicle, always take the SmartKey with you and lock the vehicle.
- ▶ Keep the vehicle SmartKey out of reach of children.

! **NOTE** Damage to the vehicle or the drivetrain due to rolling away

- ▶ Always park your vehicle safely and according to legal requirements.
- ▶ Always properly secure the vehicle against rolling away.

! **NOTE** Transmission damage caused by rolling in neutral position

If the engine is switched off and the vehicle rolls in neutral position (e.g. when towing), this can cause damage to the drivetrain and transmission.

- ▶ Only allow the vehicle to roll briefly in the neutral position.

⚠ WARNING Risk of accident and injury if parking brake is not applied

If you park the vehicle with the transmission in park position **P** and the parking brake is not engaged, the vehicle may roll away. Engaging park position **P** is not a fully adequate replacement for the parking brake. There is a risk of accident and injury.

- ▶ Secure the vehicle against rolling away as described below.

Observe the following points to ensure that the vehicle is properly secured against rolling away unintentionally:

- ▶ always apply the parking brake.
- ▶ **On uphill or downhill inclines:** turn the front wheels towards the curb.
- ▶ Shift the transmission to position **P**.
- ▶ Turn the key to position **0** and switch off the engine.

Manual parking brake

Applying or releasing the parking brake

⚠ WARNING Risk of skidding or an accident by braking with the parking brake

If you have to brake your vehicle with the parking brake, the braking distance is considerably longer and the wheels may lock. There is an increased risk of skidding and/or accident.

- ▶ Only brake the vehicle with the parking brake if the service brake has failed.
- ▶ In this case, do not apply the parking brake with too much force.
- ▶ If the wheels lock, immediately release the parking brake as much as required for the wheels to turn again.

⚠ WARNING Risk of fire and an accident if the parking brake is not released

If the parking brake is not fully released when driving, the following situations can occur:

- The parking brake can overheat and cause a fire
 - The parking brake can lose its holding function
- ▶ Completely release the parking brake before driving off.

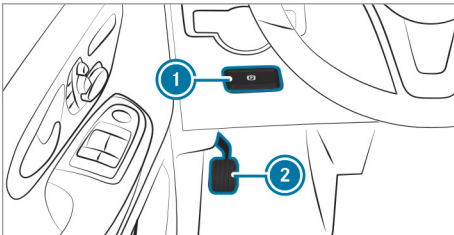

The brake lights do not light up when you brake the vehicle with the parking brake.

- ▶ **To apply the parking brake:** depress parking brake pedal ② firmly. The red **PARK** (only USA) or **(P)** (only Canada) indicator lamp in the instrument cluster lights up if the engine is running. If the vehicle is in motion, a warning tone sounds.
- ▶ **To release the parking brake:** depress the brake pedal and keep it depressed.

- ▶ Pull release handle ①. The parking brake is released abruptly. The red **PARK** (only USA) or **(P)** (only Canada) indicator lamp in the instrument cluster goes out.

Performing emergency braking with the parking brake

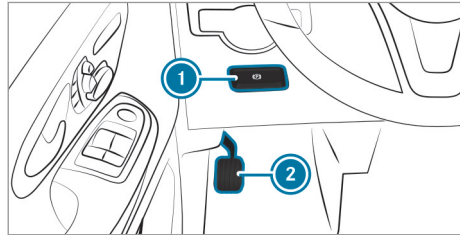

If, in exceptional cases, the service brake fails, you can use the parking brake to perform emergency braking.

- ▶ Pull release handle ① and slowly depress parking brake pedal ②.

Parking the vehicle for an extended period

Parking the vehicle for longer than four weeks

- ▶ Connect the starter battery to a trickle charger via a jump-start connection (→ page 191).

or

- ▶ Disconnect all batteries (→ page 194).

Parking the vehicle for longer than six weeks

- ▶ Contact a qualified specialist workshop and seek advice. The vehicle can otherwise suffer damage as a result of lack of use.

Driving and driving safety systems

Notes on driving systems and your responsibility

Your vehicle is equipped with driving systems which assist you in driving, parking and maneuvering the vehicle. The driving systems are only aids. These cannot replace your attention to the surroundings and do not release you from your responsibility under road traffic law. The driver is responsible for the distance to the vehicle in front, for vehicle speed, braking in good time and for staying in lane. Always pay attention to the

traffic and intervene if necessary. Be aware of the limitations regarding the safe use of these systems.

If you fail to adapt your driving style, the driving systems can neither reduce the risk of accident nor override the laws of physics. The road and weather conditions as well as the traffic situation cannot always be taken into account.

Information on vehicle sensors and cameras

Some driving and driving safety systems use cameras and radar or ultrasonic sensors to monitor the area in front of, behind or next to the vehicle.

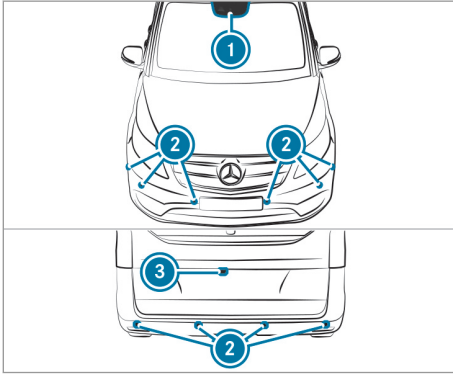

- ① Multifunction camera
- ② Ultrasonic sensors
- ③ Rear view camera

- ⓘ Depending on the vehicle's equipment, the radar sensors are integrated on the side of the rear bumpers and/or behind the Mercedes star in the radiator grill.

▲ WARNING Risk of accident due to restricted detection performance of vehicle sensors and cameras

If the area around vehicle sensors or cameras is covered, damaged or dirty, certain driving and safety systems cannot function correctly. There is a risk of an accident.

- ▶ Keep the area around vehicle sensors or cameras clear of any obstructions and clean.
- ▶ Have damage to the bumper, radiator grille or stone chipping in the area of

the front and rear windows repaired at a qualified specialist workshop.

Keep the areas of the cameras and sensors free of dirt, ice and slush (→ page 184). The sensors and cameras and their detection areas must not be covered. Do not attach additional license plate holders, advertising media, stickers, foils or stone protection foils in the detection range of the sensors and cameras. Ensure that no protruding load extends into the detection area.

In the event of damage, or following a severe impact, have the function of the sensors checked at a qualified specialist workshop. Have damage or stone chips in the area of the cameras repaired at a qualified specialist workshop.

Overview of driving systems and driving safety systems

In this section, you will find information about the following driving systems and driving safety systems:

- ABS (**A**nti-**l**ock **B**raking **S**ystem) (→ page 111)
- BAS (**B**rake **A**ssist **S**ystem) (→ page 111)
- ESP® (**E**lectronic **S**tability **P**rogram) (→ page 111)
- EBD (**E**lectronic **B**rake**f**orce **D**istribution) (→ page 113)
- Active Brake Assist (→ page 113)
- Cruise control (→ page 115)
- Active Distance Assist DISTRONIC (→ page 116)
- Hill start assist (→ page 120)
- HOLD function (→ page 121)
- Parking Assist PARKTRONIC (→ page 122)
- Rear view camera (→ page 123)
- Active Parking Assist (→ page 125)
- ATTENTION ASSIST (→ page 127)
- Blind Spot Assist (→ page 129)
- Lane Keeping Assist (→ page 129)

Function of ABS (Anti-lock Braking System)

ABS controls the brake pressure in critical situations:

- The wheels are prevented from locking when braking, e.g. during maximum full-stop braking or when there is insufficient tire traction
- The steerability of the vehicle in terms of physical possibilities is ensured when braking

If ABS intervenes, you will feel pulsations in the brake pedal. The pulsating brake pedal may be an indication of hazardous road conditions and functions as a reminder to take extra care while driving.

Function of BAS (Brake Assist System)

BAS supports you with additional braking force in an emergency braking situation.

If you depress the brake pedal quickly, BAS is activated:

- BAS automatically boosts the braking force of the brakes
- BAS can shorten the braking distance
- ABS prevents the wheels from locking

When you release the brake pedal, the brakes function as usual again. BAS is deactivated.

Function of ESP® (Electronic Stability Program)

ESP® can, within physical limits, monitor and improve driving stability and traction in the following situations:

- When driving and pulling away on wet or slippery road surfaces
- When braking

If the vehicle is deviating from the direction desired by the driver, ESP® can stabilize the vehicle by performing the following actions:

- One or more wheels are braked
- The engine output is adapted according to the situation

i Only use wheels with the recommended tire sizes. Only then will ESP® function properly.

If the  warning lamp flashes in the instrument cluster, one or more wheels have reached their traction limit:

- Adapt your driving style to suit the prevailing road and weather conditions
- Do not deactivate ESP® under any circumstances
- Only depress the accelerator pedal as far as is necessary when pulling away

If the  warning lamp lights up continuously, ESP® is not available due to a malfunction.

Observe the information on warning lamps and display messages (→ page 260).

If the  warning lamp in the instrument cluster is permanently lit, ESP® is deactivated.

Observe the following points when ESP® is deactivated:

- Vehicle stabilization is delayed and is significantly reduced in the lower speed range
- The drive wheels may start to spin
- Traction control is still active

i If ESP® is deactivated, ESP® will still support you when braking.

Switching ESP® off or on via the on-board computer (vehicles without steering wheel buttons)

⚠ WARNING Risk of skidding if ESP® is deactivated

If you deactivate ESP®, ESP® cannot carry out vehicle stabilization.

▶ ESP® should only be deactivated in the following situations.

It may be best to deactivate ESP® in the following situations:

- When using snow chains.
- In deep snow.
- On sand or gravel.

Spinning the wheels results in a cutting action, which enhances traction.

Adjusting settings using the on-board computer is only available on vehicles without the  button on the center console.

On-board computer:

→ >> Settings >> ESP

▶ **To activate/deactivate:** press the or button and confirm by pressing the button.

If ESP® is deactivated, the warning lamp in the instrument cluster lights up.

Observe the information on warning lamps and display messages (→ page 260).

Switching ESP® off or on via the on-board computer (vehicles with steering wheel buttons)

WARNING Risk of skidding if ESP® is deactivated

If you deactivate ESP®, ESP® cannot carry out vehicle stabilization.

▶ ESP® should only be deactivated in the following situations.

It may be best to deactivate ESP® in the following situations:

- When using snow chains.
- In deep snow.
- On sand or gravel.

Spinning the wheels results in a cutting action, which enhances traction.

Adjusting settings using the on-board computer is only available on vehicles without the button on the center console.

On-board computer:

→ DriveAssist >> ESP

▶ **To switch on/off:** press the button.

If ESP® is deactivated, the warning lamp in the instrument cluster lights up.

Observe the information on warning lamps and display messages (→ page 260).

Deactivating or activating ESP® using the button

WARNING Risk of skidding if ESP® is deactivated

If you deactivate ESP®, ESP® cannot carry out vehicle stabilization.

▶ ESP® should only be deactivated in the following situations.

It may be best to deactivate ESP® in the following situations:

- When using snow chains.
- In deep snow.
- On sand or gravel.

Spinning the wheels results in a cutting action, which enhances traction.

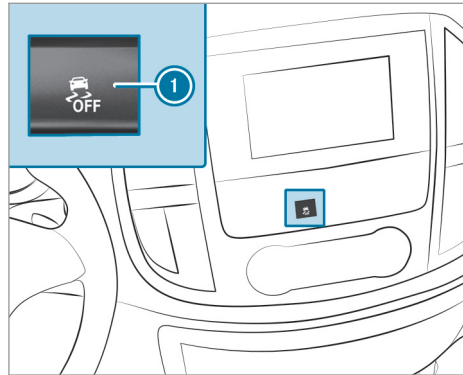

▶ Press button .

The warning lamp in the instrument cluster goes on when ESP® is deactivated.

Observe the information on warning lamps and display messages (→ page 260).

Function of ESP® Crosswind Assist

ESP® Crosswind Assist detects suddenly occurring crosswinds and helps the driver to keep the vehicle in the lane:

- ESP® Crosswind Assist is active from approx. 50 mph (80 km/h) when driving straight ahead or on gentle curves.
- The vehicle is stabilized by a targeted and one-sided brake intervention. The instrument cluster then displays a message with the traffic sign for strong crosswind.

ESP® Crosswind Assist does not react under the following conditions:

- The vehicle is subjected to severe jolts and vibrations, e.g. as a result of uneven surfaces or potholes.
- The vehicle loses traction, e.g. on snow or ice or when hydroplaning.

Function of ESP® trailer stabilization

▲ WARNING Risk of accident in poor road and weather conditions

In poor road and weather conditions, the trailer stabilization cannot prevent lurching of the vehicle/trailer combination. Trailers with a high center of gravity may tip over before ESP® detects this.

- ▶ Always adapt your driving style to suit the current road and weather conditions.

ESP® trailer stabilization can stabilize your vehicle when driving with a trailer if it starts to swerve:

- If the system detects the trailer, ESP® trailer stabilization is activated from a speed of approximately 40 mph (65 km/h).
- Slight swerving from side to side is reduced by a targeted and one-sided brake application.
- If severe swerving from side to side occurs, engine output is also reduced and all the wheels are braked.

Function of EBD (electronic brake force distribution)

EBD has the following characteristics:

- monitoring and controlling the braking force on the rear wheels
- improving driving stabilization when braking, especially on bends

Function of Active Brake Assist

Active Brake Assist consists of the following functions:

- Distance warning function
- Autonomous braking function
- Situation-dependent brake force boosting

Active Brake Assist can help you to minimize the risk of a collision with vehicles, cyclists or pedestrians, or reduce the effects of such a collision.

If Active Brake Assist has detected a risk of collision, a warning tone sounds and the  warning lamp lights up in the instrument cluster.

If you do not react to the warning, autonomous braking can be initiated in critical situations. In especially critical situations, Active Brake Assist can initiate autonomous braking directly. In this case, the warning lamp and warning tone occur simultaneously with the braking application.

If you apply the brake yourself in a situation detected as critical by Active Brake Assist, or apply the brake during autonomous braking, situation-dependent brake force boosting occurs. The brake pressure increases up to maximum full-stop braking if necessary.

If autonomous braking or a situation-dependent braking boosting effect has occurred, the  warning lamp flashes briefly and then goes out.

▲ WARNING Risk of an accident caused by limited detection performance of Active Brake Assist

Active Brake Assist cannot always clearly identify objects and complex traffic situations.

- ▶ Always pay careful attention to the traffic situation; do not rely on Active Brake Assist alone. Active Brake Assist is only an aid. The driver is responsible for maintaining a sufficiently safe distance to the vehicle in front, vehicle speed and for braking in good time.
- ▶ Be prepared to brake or swerve if necessary.

i If the system is not available, an appropriate message appears in the multifunction display.

Observe the system limitations of Active Brake Assist. Due to the nature of the system, complex but non-critical driving conditions may also cause Active Brake Assist to intervene during braking.

The individual subfunctions are available in the following speed ranges:
Distance warning function

The distance warning function warns you in the following situations:

- From a speed of approximately 4 mph (7 km/h), if your vehicle is critically close to a vehicle or pedestrian. An intermittent warning tone sounds and the  warning lamp in the instrument cluster then lights up.

Brake immediately or take evasive action, provided it is safe to do so and the traffic situation allows this.

The distance warning function can aid you in the following situations with an intermittent warning tone and a warning lamp:

- **Vehicles traveling in front:** up to approximately 155 mph (250 km/h)
- **Stationary vehicles:** up to approximately 50 mph (80 km/h)
- **Crossing vehicles:** no reaction
- **Moving pedestrians/cyclists ahead:** up to approximately 50 mph (80 km/h)
- **Crossing cyclists:** up to approximately 37 mph (60 km/h)
- **Stationary pedestrians:** no reaction

Autonomous braking function

The autonomous braking function may intervene at speeds starting from approximately 4 mph (7 km/h) in the following situations:

- **Vehicles traveling in front:** up to approximately 125 mph (200 km/h)
- **Stationary vehicles:** up to approximately 31 mph (50 km/h)
- **Crossing vehicles:** no reaction
- **Cyclists ahead:** up to approximately 50 mph (80 km/h)
- **Moving pedestrians/crossing cyclists:** up to approximately 37 mph (60 km/h)
- **Stationary pedestrians:** no reaction

Situation-dependent brake force boosting

Situation-dependent brake force boosting may intervene at speeds starting from approximately 4 mph (7 km/h) in the following situations:

- **Vehicles traveling in front:** up to approximately 155 mph (250 km/h)
- **Stationary vehicles:** up to approximately 50 mph (80 km/h)
- **Crossing vehicles:** no reaction

- **Cyclists ahead:** up to approximately 50 mph (80 km/h)
- **Moving pedestrians/crossing cyclists:** up to approximately 37 mph (60 km/h)
- **Stationary pedestrians:** no reaction

Canceling a brake application of Active Brake Assist

You can cancel a brake application of Active Brake Assist at any time by:

- Fully depressing the accelerator pedal or with kickdown.
- Releasing the brake pedal.

Active Brake Assist may cancel the brake application when one of the following conditions is fulfilled:

- You maneuver to avoid the obstacle.
- There is no longer a risk of collision.
- An obstacle is no longer detected in front of your vehicle.

System limits

Full system performance is not available for a few seconds after switching on the ignition or after driving off.

The system may be impaired or may not function in the following situations:

- In snow, rain, fog or heavy spray.
- If the sensors are dirty, fogged up, damaged or covered.
- If the sensors are impaired due to interference from other radar sources, e.g. strong radar reflections in parking garages.
- If a loss of tire pressure or a faulty tire has been detected and displayed.
- In complex traffic situations where objects cannot always be clearly identified.
- If pedestrians or vehicles move quickly into the sensor detection range.
- If pedestrians are hidden by other objects.
- If the typical outline of a pedestrian cannot be distinguished from the background.
- If a pedestrian is not detected as such, e.g. due to special clothing or other objects.
- In curves with a narrow radius.

Following damage to the front end of the vehicle, have the configuration and operation of the radar sensor checked at a qualified specialist work-

shop. This also applies to collisions at slow speeds where there is no visible damage to the front end of the vehicle.

Setting Active Brake Assist

On-board computer:

↳ DriveAssist ▶ Active Brake Assist

- ▶ Select the desired setting for the warning/reaction time and press the **OK** button. The setting is retained when the vehicle is next started.

Deactivating Active Brake Assist

- ① It is recommended that Active Brake Assist is always left activated.
- ▶ Select **Off** and press the **OK** button. The distance warning function and the autonomous braking function are deactivated. Also, the status appears in the Status overview of the **DriveAssist** menu.

The next time the vehicle is started, Active Brake Assist is automatically activated with the **Medium** setting.

When Active Brake Assist is activated, the multifunction display shows the  symbol.

At speeds up to approximately 20 mph (30 km/h), the multifunction display in vehicles with Active Parking Assist first shows the **P** status indicator. Only from a speed of approximately 20 mph (30 km/h) does the multifunction display show the **P** symbol instead of the  status indicator.

Cruise control

Function of cruise control

Cruise control accelerates and brakes the vehicle automatically in order to maintain a previously stored speed.

If you accelerate to overtake, for example, the stored speed is not deleted. If you remove your foot from the accelerator pedal after overtaking, cruise control will resume speed regulation back to the stored speed.

You operate cruise control using the cruise control lever. You can store any speed above 20 mph (30 km/h).

Observe the notes on driving systems and your responsibility, otherwise you cannot recognize dangers (→ page 109).

System limits

Cruise control may be unable to maintain the stored speed on uphill gradients. The stored speed is resumed if the uphill gradient evens out and the vehicle's speed does not fall below 20 mph (30 km/h).

On long and steep downhill gradients, you should change down to a lower gear in good time. Take particular note of this when driving a laden vehicle. By doing so, you will make use of the engine's braking effect. This will take some of the strain off the brake system and prevent the brakes from overheating and wearing too quickly.

If you change wheel size on your vehicle, check it is assigned to the correct wheel size category (→ page 218). If the category is changed without recoding the control units in the vehicle, the functioning of cruise control may be impaired.

Do not use cruise control in the following situations:

- in traffic situations where frequent speed changes are required, e.g. in heavy traffic or on winding roads
- off-road or on construction sites
- on slippery or slick roads, as the drive wheels can lose traction when accelerating and the vehicle can then skid
- if there is poor visibility

Operating cruise control

Requirements

- Cruise control is selected.
- The parking brake has been released.
- ESP® is activated, but may not intervene.
- The driving speed is at least 20 mph (30 km/h).
- The brake pedal is not depressed.

Storing and maintaining the current speed

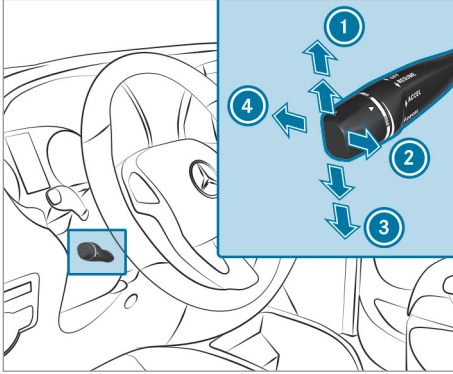

- ▶ Briefly press the cruise control lever up **1** or down **3**.
- ▶ Remove your foot from the accelerator pedal. The current speed is then saved and maintained by the vehicle.

When you activate cruise control, a message with the stored speed is briefly shown in the multifunction display's text field. The multifunction display also shows the  symbol and the stored speed.

Calling up the stored speed

⚠ WARNING Risk of accident due to stored speed

If you call up the stored speed and this is lower than your current speed, the vehicle decelerates.

- ▶ Take into account the traffic situation before calling up the stored speed.

- ▶ Briefly pull the cruise control lever in direction **2**. The last stored speed is called up and maintained by the vehicle.
- If the last stored speed has previously been deleted, the currently driven speed is stored.
- i** When you switch off the vehicle, the last speed stored is cleared.

Increasing or reducing the speed

- ▶ Press the cruise control lever up **1** or down **3** as far as the 1st pressure point. The stored speed is increased or reduced by 1 mph (1 km/h).

or

- ▶ Press the cruise control lever up **1** or down **3** beyond the 1st pressure point. The stored speed is increased or reduced by 5 mph (10 km/h).

Switching off cruise control

- ▶ Briefly press the cruise control lever forwards **4**. The  symbol and the stored speed in the multifunction display then go out.

i Cruise control is deactivated in the following situations:

- you apply the brakes.
- you drive below a speed of 20 mph (30 km/h).
- you shift the transmission to position **N**.
- ESP[®] intervenes.
- you deactivate ESP[®].
- there is a malfunction with the ABS or ESP[®] system.

If cruise control automatically deactivates, a warning tone sounds and the **CRUISE CONTROL Canceled** message appears briefly in the multifunction display.

Active Distance Assist DISTRONIC

Function of Active Distance Assist DISTRONIC

Active Distance Assist DISTRONIC maintains the set speed on free-flowing roads. If vehicles ahead are detected, the set distance is maintained, if necessary until the vehicle comes to a halt. The vehicle accelerates or brakes, depending on the distance to the vehicle in front and the set speed. Speed and distance are set and stored on the steering wheel. The speed can be set in the range between 13 mph (20 km/h) and 125 mph (200 km/h).

Other features of Active Distance Assist DISTRONIC:

- Depending on the preselected distance, DISTRONIC intervenes either dynamically (short distance) or to save fuel (long distance).
- Depending on the vehicle mass detected, the dynamics of the DISTRONIC intervention are reduced.
- Acceleration to the stored speed is initiated if the turn signal indicator is switched on to change to the overtaking lane.

Observe the notes on driving systems and your responsibility, otherwise you cannot recognize dangers (→ page 109).

System limits

The system may be impaired or may not function in the following instances, for example:

- in snow, rain, fog or heavy spray
- if there is dirt on the radar sensors or they are covered
- if there is interference from radar sources or strong radar reflections, for example in parking garages
- in traffic situations where frequent speed changes are required, e.g. in heavy traffic or on winding roads or off-road
- on roads with steep downhill or uphill gradients
- on winding roads

The system cannot detect stationary objects unless these were previously detected as moving. In addition, on slippery or slick roads, braking or accelerating can cause one or several of the drive wheels to lose traction and the vehicle can then skid.

Do not use Active Distance Assist DISTRONIC in these situations.

▲ WARNING Risk of accident from acceleration or braking by Active Distance Assist DISTRONIC

Active Distance Assist DISTRONIC may accelerate or brake in the following cases, for example:

- If the vehicle pulls away using Active Distance Assist DISTRONIC.
 - If the stored speed is called up and is considerably faster or slower than the currently driven speed.
 - If Active Distance Assist DISTRONIC no longer detects a vehicle in front or does not react to relevant objects.
- ▶ Always carefully observe the traffic conditions and be ready to brake at all times.
- ▶ Take into account the traffic situation before calling up the stored speed.

▲ WARNING Risk of accident due to insufficient deceleration by Active Distance Assist DISTRONIC

Active Distance Assist DISTRONIC brakes your vehicle with up to 50% of the possible deceleration. If this deceleration is not sufficient, Active Distance Assist DISTRONIC alerts you with a visual and acoustic warning.

- ▶ Adjust your speed and maintain a suitable distance from the vehicle in front.
- ▶ Brake the vehicle yourself and/or take evasive action.

▲ WARNING Risk of accident if detection function of Active Distance Assist DISTRONIC is impaired

Active Distance Assist DISTRONIC does not react or has a limited reaction:

- when driving on a different lane or when changing lanes
- to pedestrians, animals, bicycles or stationary vehicles, or unexpected obstacles
- to complex traffic conditions
- to oncoming vehicles and crossing traffic

As a result, Active Distance Assist DISTRONIC may neither give warnings nor intervene in such situations.

- ▶ Always observe the traffic conditions carefully and react accordingly.

Active Distance Assist DISTRONIC may not detect narrow vehicles driving in front, e.g. motorcycles or vehicles not traveling in line with your vehicle.

Operating Active Distance Assist DISTRONIC

Requirements

- The vehicle has been started. It may take up to two minutes of driving before Active Distance Assist DISTRONIC is ready for use.
- The parking brake has been released.
- ESP® is activated and is not intervening.
- Active Parking Assist is not activated.
- The transmission is in position **D**.
- The doors and tailgate/rear-end doors are closed.
- The driver's seat belt is fastened.

Activating Active Distance Assist DISTRONIC

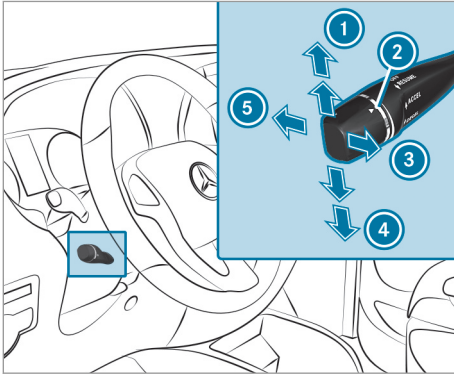

▶ **To activate with the current speed:** briefly press the cruise control lever briefly up ① or down ④ and take your foot off the accelerator pedal. The current speed is stored and appears in the speedometer and briefly in the multifunction display.

or

▶ **To activate with the stored speed:** pull the cruise control lever briefly in direction ⑤ and take your foot off the accelerator pedal. The speed appears in the speedometer and briefly in the multifunction display.

If you do not fully release the accelerator pedal, the **Active Distance Assist Suspended** message appears on the multifunction display. The distance to a slower-moving vehicle in front will then not be set. The position of the accelerator pedal will determine the speed.

When you pull the cruise control lever towards you for the first time after starting the vehicle, Active Distance Assist DISTRONIC adopts the current speed. If the current speed is less than 20 mph (30 km/h), Active Distance Assist DISTRONIC adopts the speed of 20 mph (30 km/h).

Pulling away again with Active Distance Assist DISTRONIC

▶ Remove your foot from the brake pedal.
▶ Briefly pull the cruise control lever in direction ③.

or

▶ Depress the accelerator pedal briefly with force. The functions of Active Distance Assist DISTRONIC continue to be carried out.

Deactivating Active Distance Assist DISTRONIC

⚠ WARNING Risk of an accident due to Active Distance Assist DISTRONIC being active when you leave the driver's seat

If you leave the driver's seat while the vehicle is being braked by Active Distance Assist DISTRONIC only, the vehicle can roll away.

▶ Always deactivate Active Distance Assist DISTRONIC and secure the vehicle to prevent it from rolling away before you leave the driver's seat.

▶ Briefly push the cruise control lever forwards ⑤.

or

▶ Brake if the vehicle is moving.

Increasing or reducing the speed

▶ Press the cruise control lever up ① or down ④ as far as the 1st pressure point. The stored speed is increased or reduced by 1 mph (1 km/h).

or

▶ Press the cruise control lever up ① or down ④ beyond the 1st pressure point. The stored speed is increased or reduced by 5 mph (10 km/h).

Increasing or reducing the specified distance from the vehicle in front

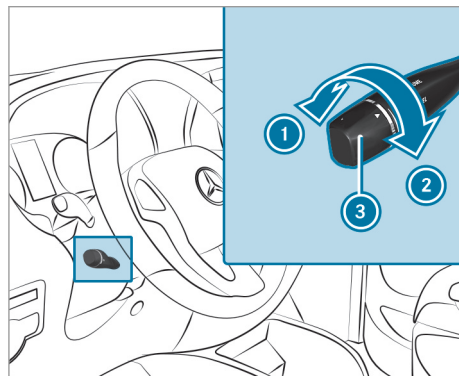

- ▶ Turn controller ③ in direction ② to increase the specified minimum distance and in direction ① to reduce the specified minimum distance.

Operating Active Distance Assist DISTRONIC

Requirements

- The vehicle has been started. It may take up to two minutes of driving before Active Distance Assist DISTRONIC is ready for use.
- The parking brake has been released.
- ESP® is activated and is not intervening.
- Active Parking Assist is not activated.
- The transmission is in position **D**.
- The doors and tailgate/rear-end doors are closed.
- The driver's seat belt is fastened.

Switching between the limiter and Active Distance Assist DISTRONIC

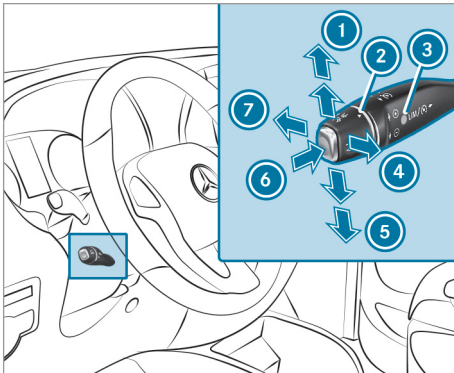

- ▶ Press button ⑥.
 - LIM indicator lamp ③ off: Active Distance Assist DISTRONIC is selected.
 - LIM indicator lamp ③ lit: the variable limiter is selected.

Activating Active Distance Assist DISTRONIC

- ▶ **To activate with the current speed:** briefly press the cruise control lever briefly up ① or down ⑤ and take your foot off the accelerator pedal.

The current speed is stored and shown on the speedometer. As in the assistance graphic menu, the multifunction display briefly shows the set specified distance and the stored speed.

or

- ▶ **To activate with the stored speed:** pull the cruise control lever briefly in direction ④ and take your foot off the accelerator pedal. The speed is displayed on the speedometer. As in the assistance graphic menu, the multifunction display briefly shows the set specified distance and the stored speed.

- ① Vehicles with Traffic Sign Assist: the speed detected by Traffic Sign Assist can be set by pulling the lever in direction ④.

- ① You can find information on DISTRONIC displays under "Displays of Active Distance Assist DISTRONIC" (→ page 120).

If you do not fully release the accelerator pedal, the **Active Distance Assist Suspended** message appears on the multifunction display. The distance to a slower-moving vehicle in front will then not be set. The position of the accelerator pedal will determine the speed.

When you pull the cruise control lever towards you for the first time after starting the vehicle, Active Distance Assist DISTRONIC adopts the current speed. If the current speed is less than 13 mph (20 km/h), Active Distance Assist DISTRONIC adopts the speed of 13 mph (20 km/h).

Pulling away again with Active Distance Assist DISTRONIC

- ▶ Remove your foot from the brake pedal.
 - ▶ Briefly pull the cruise control lever in direction ④.
- or
- ▶ Depress the accelerator pedal briefly with force. The functions of Active Distance Assist DISTRONIC continue to be carried out.

Deactivating Active Distance Assist DISTRONIC

- ▲ **WARNING** Risk of an accident due to Active Distance Assist DISTRONIC being active when you leave the driver's seat

If you leave the driver's seat while the vehicle is being braked by Active Distance Assist DISTRONIC only, the vehicle can roll away.

- ▶ Always deactivate Active Distance Assist DISTRONIC and secure the vehicle to prevent it from rolling away before you leave the driver's seat.

- ▶ Briefly push the cruise control lever forwards **⑦**.

or

- ▶ Brake if the vehicle is moving.

or

- ▶ Press button **④**.
The variable limiter is selected. LIM indicator lamp **③** in the cruise control lever lights up.

Increasing or reducing the speed

- ▶ Press the cruise control lever up **①** or down **⑤** as far as the 1st pressure point.
The stored speed is increased or reduced by 1 mph (1 km/h).

or

- ▶ Press the cruise control lever up **①** or down **⑤** beyond the 1st pressure point.
The stored speed is increased or reduced by 5 mph (10 km/h).

Increasing or reducing the specified distance from the vehicle in front

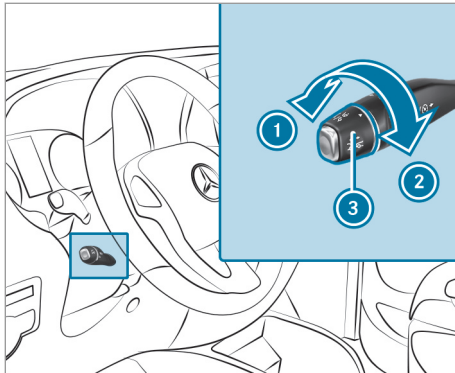

- ▶ Turn controller **③** in direction **②** to increase the specified minimum distance and in direction **①** to reduce the specified minimum distance.

As in the assistance graphic menu, the multifunction display briefly shows the set specified distance.

- i** You can find information on DISTRONIC displays under "Active Distance Assist DISTRONIC" (→ page 120).

Displays of Active Distance Assist DISTRONIC

Assistant display

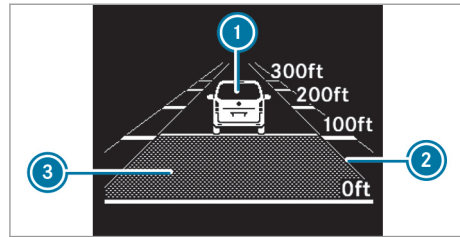

- ①** Vehicle in front, if detected
- ②** Distance indicator
- ③** Set specified distance

You can find information on the assistance graphic menu under "Assistance graphic" (→ page 144).

- i** If you set the speed, the Assistance graphic briefly appears in the multifunction display.

Displays on the speedometer

Vehicles with steering-wheel buttons:

When Active Distance Assist DISTRONIC is activated, one or two indicator segments light up in the stored speed range of the speedometer.

If Active Distance Assist DISTRONIC detects a vehicle in front, the indicator segments, located between the speed of the vehicle in front and the stored speed, light up.

Information on Hill Start Assist

Hill Start Assist holds the vehicle for a short time when pulling away on a hill under the following conditions:

- **Vehicles with automatic transmission:** the transmission is in position **[D]** or **[R]**.
- The parking brake has been released.

This gives you enough time to move your foot from the brake pedal to the accelerator pedal and depress it before the vehicle begins to roll.

⚠ WARNING Risk of accident and injury due to the vehicle rolling away

After a short time, Hill Start Assist no longer holds the vehicle.

- ▶ Swiftly move your foot from the brake pedal to the accelerator pedal. Do not

leave the vehicle when it is being held by Hill Start Assist.

HOLD function

HOLD function

The HOLD function holds the vehicle at a standstill without requiring you to depress the brake pedal, e.g. when pulling away on steep slopes or when waiting in traffic. When you depress the accelerator pedal to pull away, the braking effect is canceled and the HOLD function is deactivated.

The HOLD function is only an aid. The responsibility for the vehicle safely standing still remains with the driver.

System limits

The HOLD function is only intended to provide assistance when driving and is not a sufficient means of safeguarding the vehicle against rolling away when stationary.

- The incline may not be greater than 30%.

Activating or deactivating the HOLD function

Requirements:

- The vehicle is stationary and the engine is running.
- All the doors and the tailgate/rear-end doors are closed and the seat belt is fastened.
- The parking brake has been released.
- The selector lever is in the **[D]**, **[R]** or **[N]** position.
- Active Distance Assist DISTRONIC is deactivated.

Activating the HOLD function

⚠ WARNING Risk of an accident due to the HOLD function being active when you leave the vehicle

If the vehicle is only braked with the HOLD function it could, in the following situations, roll away:

- If there is a malfunction in the system or in the power supply.
- If the HOLD function is deactivated by depressing the accelerator pedal or brake pedal, e.g. by a vehicle occupant.

▶ Always secure the vehicle against rolling away before you leave it.

▶ Depress the brake pedal until the **[HOLD]** display appears in the multifunction display. The HOLD function is activated. You can release the brake pedal.

ⓘ If depressing the brake pedal the first time does not activate the HOLD function, wait briefly and then try again.

Deactivating the HOLD function

▶ Depress the accelerator pedal to pull away. or

▶ Depress the brake pedal until the **[HOLD]** display in the multifunction display goes out.

The HOLD function is deactivated in the following situations:

- Active Distance Assist DISTRONIC is activated.
- The transmission is shifted to position **[P]**.

In the following situations, the vehicle is held by transmission position **[P]**:

- The driver's side seat belt is not fastened, or a door or the tailgate/rear-end door is open.
- The engine is switched off.

Information on the reverse warning device

⚠ WARNING Risk of accident due to persons or objects in the maneuvering area

Other road users may ignore or fail to hear the warning tone of the reverse warning feature. There is a risk of an accident.

- ▶ Make sure that there are no persons or objects in the area in which you are maneuvering.
- ▶ It may be necessary to enlist the help of a second person when maneuvering.

The reverse warning device is a system designed to assist you in ensuring the safety of other road users. The reverse warning device cannot guarantee that no persons or objects are situated behind the vehicle.

A warning tone sounds to alert other road users when the reverse gear is engaged. If reverse gear is engaged twice in quick succession, the volume of the warning tone is lowered, for example, for night-time driving. The warning tone sounds at a normal volume by default. The volume of the warning tone has to be lowered again each time you engage reverse gear, if necessary.

When using the reverse warning device described here, observe the legal requirements for the country you are currently in.

PARKTRONIC

Function of PARKTRONIC

PARKTRONIC is an electronic parking assistance system with ultrasonic sensors. The system monitors the area around your vehicle using sensors on the front bumper and on the rear bumper. PARKTRONIC indicates visually and audibly the distance between your vehicle and an object.

The warning ranges in front of and behind the vehicle are indicated by different warning tones. PARKTRONIC is only an aid. It is not a substitute for you paying attention to the surroundings. You are always responsible for safe maneuvering, parking and exiting a parking space. Make sure that there are no persons, animals or objects etc. in the maneuvering area while maneuvering and parking or exiting parking spaces.

Requirements for automatic activation:

- The ignition is switched on.
- The parking brake has been released.

The selected transmission position determines whether the front and/or rear area is monitored.

Front area only:

- Transmission position **D**

Front and rear area:

- Transmission position **R**
- Transmission position **N**

Regardless of transmission position, PARKTRONIC automatically monitors the area behind the vehicle if the vehicle begins to roll backwards, e.g. after stopping on an uphill gradient.

PARKTRONIC is deactivated at speeds above 11 mph (18 km/h). PARKTRONIC is reactivated at speeds below 10 mph (16 km/h).

If your vehicle is equipped with the correct electrical wiring for trailer operation, PARKTRONIC detects a coupled-up trailer. PARKTRONIC is deactivated for the rear area when you establish an electrical connection between your vehicle and a trailer. If you use an adapter for the socket, unplug it from the socket after uncoupling the trailer. Otherwise, PARKTRONIC remains deactivated for the rear area.

Remove a detachable trailer coupling if it is no longer required. PARKTRONIC measures the minimum detection range to an obstacle from the bumper, not the ball neck.

Warning displays

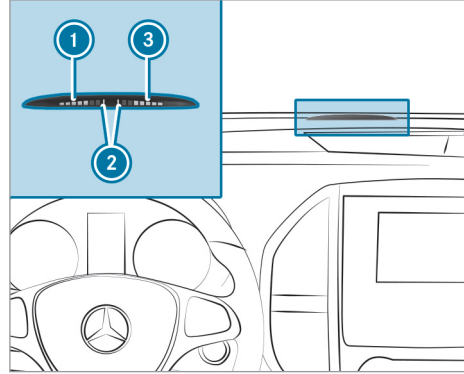

Front area warning display on the center of the cockpit

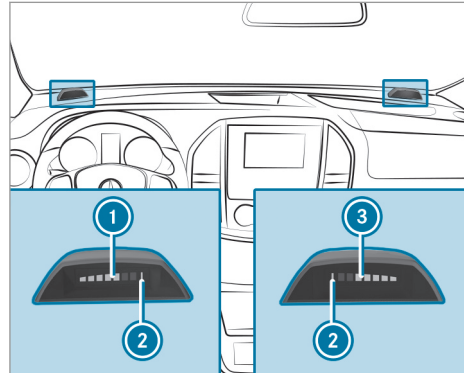

Rear area warning display on the cockpit (example: Cargo Van)

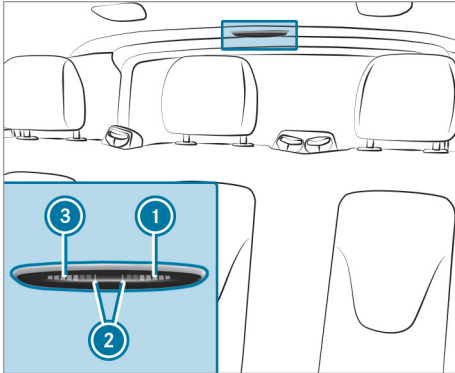

Rear area warning display in the rear compartment at the center of the headliner

- ① Warning segments for the left side of the vehicle
- ② Measurement operational readiness indicator
- ③ Warning segments for the right side of the vehicle

At least one segment will light up as the vehicle approaches an obstacle, depending on the vehicle's distance from the obstacle.

In addition, warning tones are emitted. When the distance to the obstacle is sufficient, you will hear an intermittent warning tone. The shorter the distance to the obstacle, the shorter the frequency of the intermittent warning tones becomes. When the minimum distance is reached, you hear a continuous warning tone.

The warning display for each side of the vehicle is divided into five yellow and two red segments. PARKTRONIC is active if measurement operational readiness indicator ② lights up.

System limits

PARKTRONIC may not take the following obstacles into account:

- Obstacles below the detection range, e.g. people, animals or objects
- Obstacles above the detection range, e.g. overhanging loads, overhangs or loading ramps of trucks

The sensors must be free of dirt, ice and slush. Otherwise, they may not function correctly. Clean the sensors regularly, taking care not to scratch or damage them (→ page 184).

Problems with PARKTRONIC



There is a malfunction if only the red segments of the warning display light up. In addition, a warning tone sounds for approximately two seconds. If problems persist, have PARKTRONIC checked at a qualified specialist workshop.

If the warning indicators are displaying implausible distances, it may be due to the following causes:

- **The sensors are dirty:** clean the sensors. Observe the notes on care of vehicle parts (→ page 184).
- **License plate or other detachable parts in the vicinity of the sensors are not correctly fastened:** check the license plate or the detachable parts for correct installation.
- **Interference by another source of radio or ultrasound waves:** check the function of PARKTRONIC at another location.

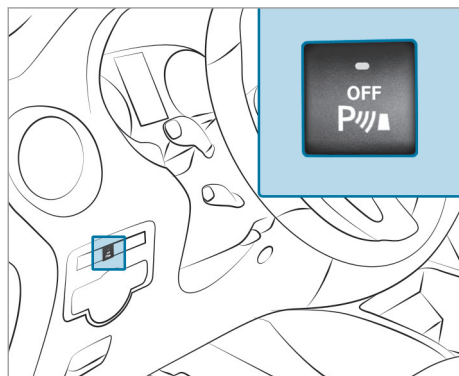
Deactivating/activating PARKTRONIC



- ▶ Press the  button. If PARKTRONIC is deactivated, the indicator lamp of the  button lights up.

Rear view camera

Function of the rear view camera

For vehicles with rear-end doors, the rear view camera is in the upper part of the license plate holder (→ page 110).

For vehicles with a tailgate, the rear view camera is located next to the tailgate handle and is protected from raindrops and dust by means of a flap. When the rear view camera is activated, this flap opens (→ page 110).

The flap closes again when you have ended the maneuvering process or you switch off the engine.

For technical reasons, the flap may remain open briefly after the rear view camera has been deactivated.

When you engage reverse gear, the image from the rear view camera is shown automatically in the media display. Dynamic guide lines show the path the vehicle will take for the current steering movement. This helps you to orient yourself and to avoid obstacles when backing up.

The rear view camera is only an aid. It is not a substitute for you paying attention to the surroundings. You are always responsible for safe maneuvering and parking. Make sure that there are no persons, animals or objects etc. in the maneuvering area while maneuvering and parking in parking spaces.

You can use the softkeys located below or to the side to choose between the following views:

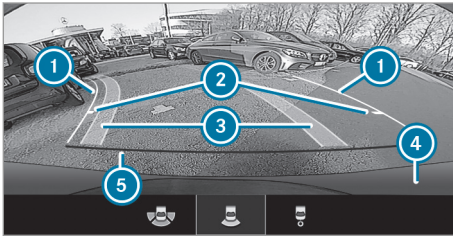

Normal view

- ① Yellow guide line, vehicle width (driven surface) depending on the current steering angle (dynamic)
- ② Yellow guide line at a distance of approximately 3.3 ft (1.0 m) from the rear area
- ③ Yellow path marking the course the tires will take at the current steering position (dynamic)
- ④ Bumper
- ⑤ Red guide line at a distance of approximately 1.0 ft (0.3 m) from the rear area

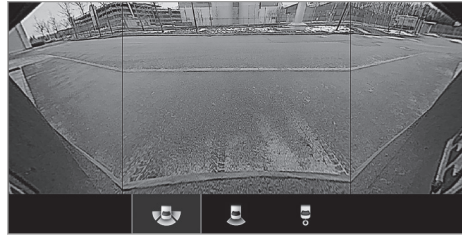

Wide-angle view

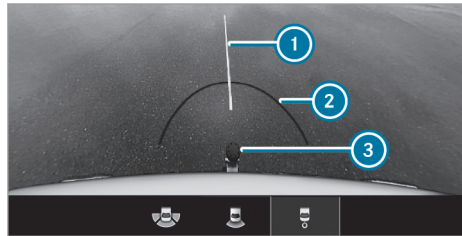

Trailer view (vehicles with a trailer hitch)

- ① Yellow guide line, locating aid
- ② Red guide line at a distance of approximately 1.0 ft (0.3 m) to the ball head of the trailer hitch
- ③ Ball head of the trailer hitch

Observe the notes on cleaning and care of the rear view camera (→ page 184).

The rear view camera may show a distorted view of obstacles, show them incorrectly or not at all. The rear view camera cannot show all objects which are very near to or under the rear bumper. It will not warn you of a collision, people or objects.

The area behind the vehicle is displayed as a mirror image, as in the inside rearview mirror.

When you shift out of reverse gear, the dynamic guide lines are faded out. If, after shifting out of reverse gear, you drive faster than 10 mph (16 km/h), the rear view camera is deactivated.

System limits

The rear view camera will not function or will only partially function in the following situations:

- if the tailgate/rear-end door is open
- if there is heavy rain, snow or fog
- if the ambient light conditions are poor, e.g. at night

- if the camera lens is covered, dirty or fogged up.
- if cameras, or vehicle components in which the cameras are installed, are damaged. Have the cameras, their positions and their setting checked at a qualified specialist workshop.
- ① The media display contrast may be impaired due to direct sunlight or other light sources. In this case, pay particular attention.
- ① Have the media display repaired or replaced if, for example, pixel errors considerably restrict its use.
- ① Objects that are not at ground level appear further away than they actually are. This includes, for example:
 - the bumper of a vehicle parked behind
 - the drawbar of a trailer
 - the ball neck of a trailer hitch
 - the tail-end of a truck
 - slanted posts

Only use the guide lines of the camera image for orientation. Do not travel further than the lowest horizontal guide line when approaching objects. You may otherwise damage your vehicle and/or the object.

Active Parking Assist

Function of Active Parking Assist

Active Parking Assist is an electronic parking assistance system which automatically locates and measures parking spaces on both sides of the vehicle when you are driving forwards up to a speed of approximately 22 mph (35 km/h).

If all requirements are met, the **[P]** display appears in the multifunction display. The system then independently locates and measures parallel and perpendicular parking spaces on both sides of the vehicle.

When Active Parking Assist has detected parking spaces, the **[P]** display appears in the multifunction display. The arrows show on which side of the road free parking spaces are located.

Active Parking Assist displays parking spaces on the co-driver side as standard. The parking spaces on the driver's side are only displayed if you operate the turn signal on the driver's side. When parking on the driver's side, you must operate the turn signal until you have started active

parking assistance by pressing the **[OK]** steering-wheel button.

Active Parking Assist can assist you with an active steering intervention and brake application during parking and exiting the parking space.

Active Parking Assist is only an aid. It is not a substitute for your attention to the surroundings. You are always responsible for safe maneuvering, parking and exiting a parking space. Make sure that no persons, animals or objects etc. are in the path of your vehicle.

Active Parking Assist is canceled in the following cases, among others:

- Parking Assist PARKTRONIC is deactivated.
- You steer.
- You apply the parking brake.
- Parking using Active Parking Assist is no longer possible.
- You exceed a speed of 6 mph (10 km/h).
- A wheel spins and ESP[®] intervenes or fails.
- You engage transmission position **[P]**.
- You open a door or the tailgate/rear-end door, or unfasten your seat belt, on vehicles with an automatic transmission.

PARKTRONIC is deactivated for the rear area when you have a trailer coupled up and establish an electrical connection between your vehicle and the trailer. Active Parking Assist is then not available.

System limits

Objects located above or below the detection range of Active Parking Assist are not detected when the parking space is being measured. They are also not taken into account when the parking maneuver is calculated, e.g. overhanging loads, overhangs or loading ramps of trucks, or the boundaries of parking spaces. In some circumstances, Active Parking Assist may therefore guide you into the parking space prematurely.

⚠ WARNING Risk of accident due to objects located above or below the detection range of Active Parking Assist

If there are objects above or below the detection range, the following situations may arise:

- Active Parking Assist may steer too early.
- The vehicle may not stop in front of these objects.

This could cause a collision.

- ▶ In these situations, do not use Active Parking Assist.

Snowfall or heavy rain may lead to a parking space being measured inaccurately. Parking spaces that are partially occupied by trailer drawbars might not be identified as such or be measured incorrectly. Only use Active Parking Assist on level, high-grip ground.

Do not use Active Parking Assist in the following situations, among others:

- In extreme weather conditions such as ice, packed snow or in heavy rain
- When cornering
- For parking spaces which are not on the same level as the road, e.g. not on the pavement
- When transporting a load that protrudes beyond the vehicle
- When snow chains are installed

Active Parking Assist may also display parking spaces that are not suitable for parking, for example:

- Parking spaces where parking is prohibited
- Parking spaces on unsuitable surfaces

Active Parking Assist will not assist you with parking spaces perpendicular to the direction of travel in the following situations:

- If two parking spaces are located immediately next to each other
- If the parking space is immediately next to a low obstacle such as a curb
- If you are parking forwards

Active Parking Assist will not assist you with parking spaces parallel or perpendicular to the direction of travel in the following situations:

- If the parking space is on a curb
- If the system deems the parking space to be blocked, such as by foliage or grass paving blocks
- If the area is too small for the vehicle to maneuver into
- If the parking space is bordered by an obstacle, e.g. a tree, a post or a trailer

Parking using Active Parking Assist

- ▲ **WARNING** Risk of accident due to insufficiently securing the vehicle against rolling away when exiting the vehicle

If you leave the driver's seat when the vehicle is being braked by Active Parking Assist only, it could roll away in the following situations:

- if there is a malfunction in the system or in the power supply.
- if the electrical system in the engine compartment, the battery or the fuses are tampered with.
- if the battery is disconnected.
- if the vehicle is accelerated, e.g. by a vehicle occupant.

- ▶ Before leaving the driver's seat, always secure the vehicle against rolling away.

- ▶ Bring the vehicle safely to a stop when the parking symbol with an arrow shows the desired parking space.

- ▲ **WARNING** Risk of accident due to vehicle swinging out while parking or pulling out of a parking space

While parking or pulling out of a parking space, the vehicle swings out and can drive onto areas of the oncoming lane.

This could cause you to collide with objects or other road users.

- ▶ Pay attention to objects and other road users.
- ▶ Where necessary, stop the vehicle or cancel the parking procedure with Parking Pilot.

- ▶ Shift the transmission to position **R**. The multifunction display shows the **Start Parking Assist? Yes: OK No: ** message and the location of the parking space.

- ▶ **To cancel the process:** press the **** steering-wheel button or drive off.

or

- ▶ **To park using active parking assistance:** press the **** steering-wheel button. The **Parking Assist Active Accelerate and Brake Observe Surroundings** message is shown in the multifunction display.
- ▶ Release the steering wheel.

- ▶ Reverse the vehicle, being ready to brake at all times. Reverse slowly, and do not drive faster than 6 mph (10 km/h). Parking assistance is otherwise canceled and Active Parking Assist is stopped. When the vehicle approaches the rear border of the parking space, Active Parking Assist can brake it to a standstill.
- ▶ Stop at the rear border of the parking space. Stop when PARKTRONIC sounds the continuous warning tone, if not before.

Maneuvering may be required in tight parking spaces. Observe the messages on the multifunction display.

On completion of the parking procedure, the **Active Parking Assist Finished** message appears and an acoustic signal sounds. Active Parking Assist no longer supports you with steering interventions and brake applications.

Exiting a parking space with Active Parking Assist

Requirements:

- The vehicle has been parked parallel to the direction of travel using Active Parking Assist.
- The border of the parking space must be high enough at the front and the rear; a curb, for instance, is not sufficient.
- The border of the parking space must not be too wide. Your vehicle can be maneuvered into a position at a maximum angle of 45° to the starting position in the parking space.
- A maneuvering distance of at least 40 in (1 m) must be available.

Please note that you are responsible for the vehicle and surroundings during the entire parking procedure.



- ▶ Start the vehicle.
- ▶ Switch on the turn signal on the side you intend to exit the parking space.

⚠ WARNING Risk of accident due to vehicle swinging out while parking or pulling out of a parking space

While parking or exiting a parking space, the vehicle swings out and can drive onto areas of the oncoming lane.

This could cause you to collide with objects or other road users.

- ▶ Pay attention to objects and other road users.
- ▶ Where necessary, stop the vehicle or cancel the parking procedure with Active Parking Assist.

- ▶ Shift the transmission to position **D** or **R**. The multifunction display shows the **Start Parking Assist? Yes: OK No: ** message and the location of the parking space.
- ▶ **To cancel the process:** press the **** steering-wheel button or drive off.

or

- ▶ **To exit the parking space using active parking assistance:** press the **** steering-wheel button.

The **Parking Assist Active Accelerate and Brake Observe Surroundings** message is shown in the multifunction display.

- ▶ Release the steering wheel.
- ▶ Pull away and be ready to brake at all times. Reverse slowly, and do not drive faster than 6 mph (10 km/h). Parking assistance is otherwise canceled and Active Parking Assist is stopped. When the vehicle approaches the rear border of the parking space, Active Parking Assist can brake it to a standstill.

Maneuvering may be required in tight parking spaces. Observe the messages on the multifunction display.

On completion of the parking procedure, the **Active Parking Assist Finished** message appears and an acoustic signal sounds. Active Parking Assist no longer supports you with steering interventions and brake applications.

The parking assistance function of Active Parking Assist is stopped. You will then have to steer and merge into traffic on your own. PARKTRONIC is still available.

ATTENTION ASSIST

Function of ATTENTION ASSIST

ATTENTION ASSIST can assist you on long, monotonous journeys, e.g. on highways and trunk roads. If ATTENTION ASSIST detects indicators of fatigue or increased lapses in concentration on the part of the driver, it suggests taking a break.

ATTENTION ASSIST is only an aid. It cannot always detect drowsiness or increased lapses in

concentration in good time. The system is not a substitute for a well-rested and attentive driver. On long journeys, take regular and timely breaks that allow you to rest properly.

If fatigue or increased lapses in concentration are detected, the **ATTENTION ASSIST: Take a Break!** or **Attent. Asst Take Break!** warning appears in the instrument cluster.

You can acknowledge the message and take a break if necessary. If you do not take a break and ATTENTION ASSIST continues to detect increased lapses in concentration, you will be warned again after a minimum of 15 minutes.

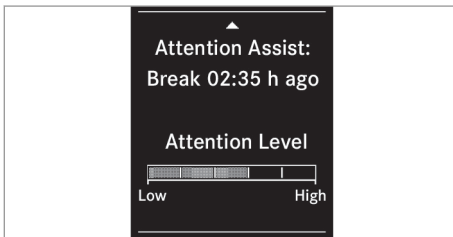

For vehicles with steering wheel buttons you can have the current ATTENTION ASSIST (Attention Level) assessment displayed.

The following information is displayed:

- The journey length since the last break
- The attention level determined by ATTENTION ASSIST:
 - The fuller the bar is, the higher the detected attention level is
 - The bar empties as attentiveness decreases

If ATTENTION ASSIST cannot calculate the attention level and cannot issue a warning, the **System Suspended** message appears.

The bar display is then dimmed. This is the case, for example, if you are predominantly driving at a speed below 40 mph (60 km/h) or above 125 mph (200 km/h).

System limits

ATTENTION ASSIST is active in the 40 mph (60 km/h) to 125 mph (200 km/h) speed range.

The functionality of ATTENTION ASSIST is restricted, and warnings may be delayed or not occur at all, in the following situations:

- The journey lasts less than approximately 30 minutes
- The road condition is poor (uneven road surface or potholes)
- The vehicle is subjected to a strong crosswind
- You have a sporty driving style (high cornering speeds or high rates of acceleration)
- The time is set incorrectly
- You change lanes and vary your speed frequently in active driving situations

The ATTENTION ASSIST drowsiness or alertness assessment is deleted and restarted when continuing the journey in the following situations:

- You switch off the engine
- You unfasten your seat belt and open the driver's door (e.g. change drivers or take a break)

Deactivating or activating ATTENTION ASSIST (vehicles without steering wheel buttons)

On-board computer:

→ Settings → Attention Assist

- ▶ **To activate/deactivate:** press the or button and confirm by pressing the button.

When ATTENTION ASSIST is active, the indicator lamp lights up in the instrument cluster.

Deactivating or activating ATTENTION ASSIST (vehicles with steering wheel buttons)

On-board computer:

→ DriveAssist → ATTENTION ASSIST

- ▶ **To change the setting:** press the button and select the setting.

If ATTENTION ASSIST is activated, the symbol is shown in the status area of the multifunction display.

You can choose between the following settings:

- **Off**
- **Standard:** normal system sensitivity.
- **Sensitive:** higher system sensitivity. The driver is warned earlier and the attention level detected by the system (Attention Level) is adapted accordingly.

Blind Spot Assist

Function of Blind Spot Assist

Blind Spot Assist uses two lateral, rear-facing radar sensors to monitor the area up to 10 ft (3 m) behind and 10 ft (3 m) directly next to your vehicle.

i USA only:

This device has been approved by the FCC as a "Vehicular Radar System". The radar sensor is intended for use in an automotive radar system only. Removal, tampering, or altering of the device will void any warranties, and is not permitted by the FCC. Do not tamper with, alter, or use in any non-approved way. Any unauthorized modification to this device could void the user's authority to operate the equipment.

⚠ WARNING Risk of accident despite Blind Spot Assist

Blind Spot Assist does not react to either stationary objects or vehicles approaching and overtaking you at a greatly different speed. Blind Spot Assist cannot warn drivers in these situations.

▶ Always pay careful attention to the traffic situation and maintain a safe distance at the side of the vehicle.

Observe the notes on driving systems and your responsibility, otherwise you cannot recognize dangers (→ page 109).

If a vehicle is detected above speeds of approximately 20 mph (30 km/h) and this vehicle subsequently enters the monitoring range directly next to your vehicle, the warning lamp in the outside mirror lights up red.

If a vehicle is detected close to your vehicle in the lateral monitoring range and you switch on the turn signal indicator in the corresponding direction, a warning tone sounds. The red warning lamp in the outside mirror flashes. If the turn signal indicator remains switched on, all other detected vehicles are indicated only by the flashing of the red warning lamp.

When you overtake a vehicle, the warning only occurs if the difference in speed is less than 7 mph (11 km/h).

System limits

Blind Spot Assist may be limited in the following situations:

- If there is dirt on the sensors or the sensors are obscured
- If there is poor visibility, e.g. due to fog, heavy rain, snow or spray
- If narrow vehicles are within the monitoring range, e.g. bicycles
- If the road has very wide or very narrow lanes
- If vehicles are not driving in the middle of their lane

Warnings may be issued in error when driving close to crash barriers or similar solid lane borders. Warnings may be interrupted when driving alongside long vehicles, for example trucks, for a prolonged time.

Blind Spot Assist is not operational when reverse gear is engaged.

If you couple up a trailer, make sure that you have correctly established the electrical connection. Blind Spot Assist is then deactivated and the [Blind Spot Assist Currently Unavailable See Operator's Manual](#) message appears in the multifunction display.

Activating/deactivating Blind Spot Assist

On-board computer:

↪ DriveAssist ▶ Blind Spot Assist

▶ **To activate/deactivate:** press the button.

i Additionally, the status overview in the assistance menu also displays the status of Blind Spot Assist (→ page 144).

If you switch on the ignition while Blind Spot Assist is activated, the warning lamps in the outside mirrors light up for approx. 1.5 seconds.

Lane Keeping Assist

Function of Lane Keeping Assist

Lane Keeping Assist serves to protect you against unintentionally leaving your lane. You are also warned by a vibration in the steering wheel and by the status symbol flashing in the instrument cluster. Lane Keeping Assist is only an aid and is not intended to keep the vehicle in the lane without the driver's cooperation.

Observe the notes on driving systems and your responsibility, otherwise you cannot recognize dangers (→ page 109).

The function is available in the speed range between 40 mph (60 km/h) and 125 mph (200 km/h).

The warning is issued when the following conditions are met at the same time:

- If Lane Keeping Assist detects lane markings.
- If a front wheel drives over lane markings.

In order that you are warned only when necessary and in good time if you cross the lane marking, the system differentiates between various conditions and warns you accordingly.

The warning vibration occurs earlier under the following conditions:

- you approach the outer lane marking on a curve.
- the road has very wide lanes, e.g. a freeway.
- the system detects solid lane markings.

The warning vibration occurs later under the following conditions:

- you are driving on a road with narrow lanes.
- you cut the corner on a curve.

i You may also be warned by a vibration in the steering wheel (4x2 version) or by a warning tone (4x4 version) and the status symbol flashing in the Instrument Display.

System limits



The system may be impaired or may not function in the following situations:

- If there is poor visibility, e.g. due to insufficient illumination of the road, if there are highly variable shade conditions or in rain, snow, fog or spray.
- Glare from oncoming traffic, direct sunlight or reflections.
- There is dirt on the windshield in the vicinity of the multifunction camera or the camera is fogged up, damaged or obscured.
- There are no or several ambiguous lane markings for one lane, e.g. in the vicinity of construction sites.
- If the lane markings are worn away, dark or covered up.
- If the distance to the vehicle in front is too short and thus the lane markings cannot be detected.

- The lane markings change quickly, e.g. lanes branch off, cross one another or merge.
- The road is very narrow and winding.

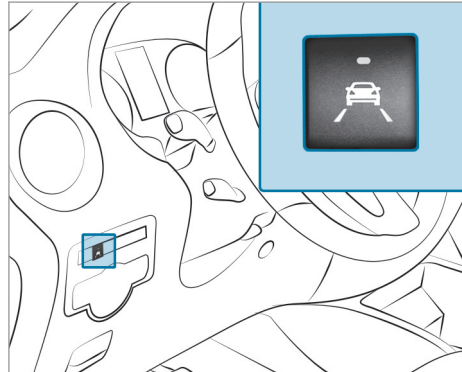
Activating/deactivating Lane Keeping Assist



▶ Press the  button. If the indicator lamp in the button lights up and the multifunction display shows the  symbol in the status area, Lane Keeping Assist is activated but not ready for use.

If you are driving with Lane Keeping Assist activated at speeds above 40 mph (60 km/h) and lane markings are detected, the multifunction display shows the  symbol highlighted in the status area. Lane Keeping Assist is then ready for use.

i The status overview in the assistance menu also displays the status of Lane Keeping Assist (→ page 144).

Setting the sensitivity of Lane Keeping Assist

On-board computer:

↳ DriveAssist ▶▶ Lane Keeping Assist

▶ Select the **Standard** or **Adaptive** setting.

In the **Standard** setting, no warning vibration occurs in the following situations:

- You operate the turn signal in the corresponding direction. In this event, the warnings are suppressed for a certain period of time.
- A driving safety system, such as ABS, BAS or ESP®, intervenes or performs a control action.

In the **Adaptive** setting, there will also be no warning vibration in the following situations:

- you accelerate hard, e.g. kickdown.
- you brake hard.

- you steer actively, e.g. swerve to avoid an obstacle or change lane quickly.
- you cut the corner on a sharp curve.

Trailer operation

Notes on trailer operation

▲ WARNING Risk of accident and injury if the tongue weight is exceeded

The carrier system may detach from the vehicle, thereby endangering other road users.

- ▶ Always comply with the permissible tongue weight when using a carrier.

▲ WARNING Risk of accident due to unsuitable ball neck

If you install an unsuitable ball neck, the trailer hitch and the rear axle may be overloaded.

This can significantly impair the driving characteristics and the trailer may become loose. There is a risk of fatal injury.

- ▶ Only install a ball neck that complies with the permissible dimensions and is designed for the requirements of trailer operation.
- ▶ Do not modify the ball neck or the trailer hitch.

You can find specifications regarding the ball neck on the trailer's identification plate. You can find specifications regarding the trailer on the towing vehicle's identification plate and in the technical data (→ page 233).

▲ WARNING Risk of accident and injury due to an incorrectly installed ball coupling

If the ball coupling is not installed and engaged correctly, it may become detached during travel and endanger other road users. There is a risk of fatal injury.

- ▶ Install and secure the ball coupling as described in the ball coupling manufacturer's installation instructions.
- ▶ When the ball coupling has been installed, ensure that it is correctly secured before every trip.

▲ WARNING Risk of accident due to an incorrectly installed and secured ball coupling

If the ball coupling has not been correctly installed and secured, the trailer can become detached.

- ▶ Install and secure the ball coupling as described in the ball coupling manufacturer's installation instructions.
- ▶ When the ball coupling has been installed, ensure that it is correctly secured before every trip.

You can attach carrier systems such as a bicycle rack or load-bearing implement to the ball neck. When using carrier systems on the ball neck, the maximum load capacity is 165 lb (75 kg).

Be sure to comply with the operating instructions of the manufacturer of the trailer coupling and the ball neck.

Place your vehicle/trailer combination on surfaces that are as even as possible and secure it against rolling away (→ page 108). Couple and uncouple the trailer carefully.

Note the following regarding the tongue weight:

- Make full use of the maximum tongue weight, where possible.
- Never fall below a legally prescribed minimum tongue weight; the tongue weight must always be positive.
- Do not exceed or fall below the permissible tongue weights – this must be observed during loading and unloading of the trailer.

Do not exceed the following values:

- Permitted braked or unbraked towing capacity

The maximum permissible towing capacity for unbraked trailers is 1,653 lbs (750 kg).

- Permissible rear axle load of the towing vehicle
- Permissible gross weight of the towing vehicle
- Permissible gross weight of the trailer
- Permissible gross combination weight
- Maximum permissible speed of the trailer

The relevant permitted values, which must not be exceeded, can be found in the following places:

- In your vehicle documents
- On the identification plate of the trailer hitch
- On the trailer's identification plate
- On the vehicle identification plate

If there are discrepancies between the values, the lowest one shall apply.

Before driving off, ensure the following:

- The tire pressure on the rear axle of the towing vehicle has been set for the maximum load.
- The headlamps have been set correctly.

Values approved by the manufacturer can be found on the identification plates and in the section for the towing vehicle (→ page 207).

If you require explanations regarding the information in the Operator's Manual, contact a Mercedes-Benz Commercial Van Center.

Comply with the maximum permissible speed of 50 mph (80 km/h) or 62 mph (100 km/h), even in countries in which higher speeds are permitted for vehicle/trailer combinations.

Attach only an approved trailer hitch to your vehicle. Use only a ball neck that has been approved for your vehicle. Further information about availability and installation, including that of the trailer electrics, is available from any qualified specialist workshop.

- ⓘ Your vehicle's bumpers are not suitable for installing detachable trailer hitches.

Do not attach any rented trailer hitches or any other detachable trailer hitches to the bumpers.

Reduce the risk of damage to the ball neck. If you do not need the ball neck, remove it from the ball neck mount.

- ⓘ During trailer operation, remember that PARKTRONIC is available only to a limited extent, if at all.
- ⓘ The height of the ball head will change depending on the vehicle's load. In this case, use a trailer with a height-adjustable drawbar.

Coupling/uncoupling a trailer

Requirements:

- The ball neck must be engaged in a securely locked position.

Trailers with 7-pin plugs can be connected to the vehicle using the following adapters:

- Adapter plug
- Adapter cable

Coupling a trailer

! **NOTE** Damage to the starter battery due to full discharge

Charging the trailer battery using the power supply of the trailer can damage the starter battery.

- ▶ Do not use the vehicle's power supply to charge the trailer battery.

▶ Vehicles with automatic transmission:

- ▶ shift the transmission to position **P**.
- ▶ Apply the vehicle's parking brake.
- ▶ Close all the doors.
- ▶ Position the trailer on a level surface behind the vehicle.
- ⓘ The height of the ball head will change depending on the vehicle's load. In this case, use a trailer with a height-adjustable drawbar.
- ▶ Couple up the trailer.



▶ To install an adapter: open the cover of the socket.

- ▶ Insert the plug with tab ① into the socket's groove ③.
- ▶ Turn bayonet coupling ② to the right as far as it will go.
- ▶ Let the cover engage.

- ▶ Attach the cable to the trailer with cable ties (only in the case of adapter cable).
- ▶ Make sure that the cable is always slack for ease of movement during cornering.
- ▶ Establish all electrical and other connections to the trailer. In the process, attach the trailer's breakaway cable to the eyelet on the ball neck.
- ▶ Check that the trailer's lighting system works properly.
- ▶ Indicate in both directions and check whether the corresponding turn signal light on the trailer is flashing.
A trailer is detected only if the electrical connection is established correctly and the lighting system is in working order. The function of other systems also depends on this, e.g. ESP®, PARKTRONIC, Active Parking Assist, Blind Spot Assist or Lane Keeping Assist.

Even if the trailer is connected correctly, a message may nevertheless appear on the multifunction display in the following cases:

- LEDs have been installed in the trailer's lighting system.
 - The current has fallen below the trailer lighting system's minimum current (50 mA)
- i** You can connect accessories up to a maximum of 240 W to the permanent power supply.
- ▶ Remove objects or devices that prevent the trailer from rolling, e.g. chocks.
 - ▶ Release the trailer's parking brake.

Observe the maximum permissible trailer dimensions (width and length).

Most states and all Canadian provinces prescribe:

- Safety chains between the towing vehicle and the trailer. The chains should be routed in a criss-cross pattern under the drawbar. They must be connected to the trailer hitch and not to the bumper or to the vehicle's axle.
Leave sufficient slack in the chains. This also allows for sharp cornering.
- A separate brake system for specific trailers.
- Safety shutoff for braked trailers. Determine the specific requirements according to the relevant laws.

If the trailer becomes detached from the towing vehicle, the safety shutoff will activate the trailer brakes.

Uncoupling a trailer

⚠ WARNING Risk of being crushed and becoming trapped when uncoupling a trailer

When uncoupling a trailer with an engaged inertia-activated brake, your hand may become trapped between the vehicle and the trailer drawbar.

- ▶ Do not uncouple trailers with an engaged overrun brake.

ℹ NOTE Damage when uncoupling in a state of overrun

Uncoupling in a state of overrun can damage the vehicle.

- ▶ Do not uncouple trailers with an engaged overrun brake.

- ▶ Shift the transmission to position **P**.
- ▶ Apply the vehicle's parking brake.
- ▶ Close all the doors.
- ▶ Apply the trailer's parking brake.
- ▶ Further secure the trailer against rolling away with a wheel chock or similar object.
- ▶ Remove the trailer cables and safety chains.
- ▶ Uncouple the trailer.

Information about towing a trailer

Operating a trailer is subject to many statutory regulations such as speed restrictions.

Many states also require an auxiliary separate functional braking system when towing a weight that exceeds a certain limit. For your safety, it is recommended to use a separate functional braking system on any towed vehicle.

Make sure that your trailer combination meets local regulations. This not only applies to your place of residence, but also to your destination. Information on this can be obtained from the police and local authorities.

Comply with the following when driving with a trailer:

- Practice cornering, stopping and backing up in a traffic-free location. In this way, you will

gain driving experience and become accustomed to the new handling characteristics.

- Before driving, check the following:
 - that the trailer tow hitch and ball coupling are secure
 - that the safety switch for braked trailers is functioning correctly
 - that the safety chains are secure and undamaged
 - that the electrical connections are secure
 - that the lights are functioning correctly
 - the wheels for damage and correct tire pressure (→ page 204)
- Adjust the outside mirrors so that you have a clear view of the rear section of the trailer.
- If the trailer is equipped with an individual braking system, check before each journey whether the brakes are functioning correctly.
- If the trailer has electronically controlled brakes, pull away carefully with the vehicle/trailer combination. Brake manually using the brake controller and check whether the brakes are functioning correctly.
- Secure the load on the trailer in line with the requirements and rules for load-securing methods.
- When driving with a trailer, check at regular intervals that the load is secure and that the lights and brakes are functioning correctly.
- Bear in mind that the handling characteristics are more unstable when towing a trailer than when driving without a trailer. Avoid sudden steering movements.
- The vehicle/trailer combination is heavier, accelerates more slowly, has a reduced climbing ability and an increased braking distance. It is more susceptible to side winds and requires careful steering.
- If possible, do not brake suddenly, but rather moderately at first so that the trailer can activate its brakes. Then increase the pressure on the brake pedal.
- If the automatic transmission shifts between gears on uphill or downhill gradients, restrict the shift range. Select shift range 4, 3, 2 or 1. A lower gear and reduced speed decrease the risk of engine damage.
- When driving on a downhill gradient, shift to a lower gear to use the engine's braking effect.

Avoid constant braking, as this could cause the vehicle brakes and possibly also the trailer brakes to overheat.

- If the coolant temperature increases significantly when the air-conditioning system is switched on, switch the air-conditioning system off.

Coolant heat can also be dissipated by switching the airflow and the temperature of the heater or air conditioning to the maximum level. Open the windows if necessary.

- When overtaking, pay particular attention to the increased overtaking distance of your vehicle/trailer combination.

Due to the length of your vehicle/trailer combination you will require a longer stretch of road before switching back to the original lane.

Permissible trailer loads and tongue weights

Weight information

⚠ WARNING Risk of accident due to an unbraked trailer with an excessive gross weight

If you pull an unbraked trailer with a gross trailer weight (GTW) of more than 1,653 lbs (750 kg), the vehicle's brake system may overheat.

This increases the braking distance and may even cause the brake system to fail.

▶ Always use a trailer with a separate braking system if you are pulling a gross trailer weight (GTW) of more than 1,653 lbs (750 kg).

! NOTE Damage to the drive train, transmission or trailer tow hitch due to excess gross combination weight

The permissible gross combination weight is exceeded.

The drive train, the transmission or the trailer tow hitch may be damaged.

▶ Comply with the permissible gross combination weight.

For vehicles with a permissible gross weight of 6,614 lbs (3,000 kg), the permissible gross combination weight is less than the sum of the permissible gross vehicle weight and the permissible

trailer load. If either the vehicle or the trailer is fully laden, the permitted gross vehicle weight or the permitted trailer load values are reduced accordingly. In this case, you may only partially load the trailer or the vehicle.

The gross trailer weight (GTW) is calculated by adding the weight of the trailer to the weight of its load and equipment. If the trailer is equipped with a separate braking system, the permissible gross trailer weight is 5,000 lbs (2,268 kg).

The maximum drawbar tongue weight on the ball head (TWR) is 500 lbs (227 kg). However, the actual tongue weight must not exceed the value given on the trailer hitch or trailer identification plates. Where the values differ, the lowest shall always apply.

The gross combined weight rating (GCWR) is calculated on the basis of the gross trailer weight plus the gross vehicle weight, including a driver's weight of approximately 150 lbs (68 kg). The maximum permissible gross combination weight is vehicle-specific and equipment-dependent. When driving with a trailer, you should not exceed the maximum permissible gross combination weight rating (GCWR).

The permissible values, which must not be exceeded, can be found in your vehicle documents and on the identification plates of the trailer hitch, the trailer and the vehicle. The values approved by the manufacturer can also be found in the "Technical data" section. Where the values differ, the lowest shall always apply.

Loading the trailer

Use a tongue weight that is as close as possible to the maximum permissible tongue weight. Do not undershoot the minimum permissible tongue weight. Otherwise, the trailer may become detached.

- Distribute the load over the vehicle and the trailer so as not to exceed either the maximum permissible values for the gross vehicle weight rating (GVWR) and gross trailer weight (GTW), the gross combination weight rating (GCWR), or the maximum permissible gross axle weight rating (GAWR) and tongue weight (TWR) of your vehicle.
- Add the rear axle load to the drawbar tongue weight (TWR) on the ball head. This will ensure that you do not exceed the permissible gross axle weight rating (GAWR).
- Add the vehicle load to the drawbar tongue weight (TWR) on the ball head. This will

ensure that you do not exceed the permissible gross vehicle weight rating (GVWR).

Checking vehicle and trailer weight

- Make sure that the weights of the towing vehicle and the trailer comply with the maximum permissible values. Have the vehicle/trailer combination weighed on a calibrated weighing machine. The vehicle/trailer combination comprises the towing vehicle including driver, passengers and load as well as the laden trailer.
- Check the maximum permissible gross axle weight rating of the front and rear axles (GAWR), the gross trailer weight (GTW), the gross combination weight rating (GCWR) and the drawbar tongue weight (TWR).

Trailer power supply

Incorrect cabling of the connector plug may interfere with other electronic systems in the vehicle. Mercedes-Benz therefore recommends that you have the cabling of the connector plug carried out at a qualified specialist workshop.

You can connect accessories up to a maximum of 240 W to the permanent power supply. Do not charge a trailer battery using the power supply.

Your vehicle may be equipped with a range of electrical equipment for trailer operation. Depending on your trailer, you may need an adapter for the electrical connection between the trailer and your vehicle.

The trailer socket of your vehicle is equipped with a permanent power supply at the factory.

The permanent power supply is supplied via trailer socket pin 4.

Note that the trailer's permanent power supply is not switched off when the vehicle's on-board electrical system voltage is low. This could completely discharge your vehicle's starter battery.

Further information on the electrical equipment currently installed on your vehicle and on installing the trailer electrics can be obtained at a qualified specialist workshop.

Notes on the instrument cluster and on-board computer

⚠ WARNING Risk of accident due to an instrument cluster malfunction

If the instrument cluster has failed or malfunctioned, you may not notice restrictions to safety-relevant system functions.

The operating safety of your vehicle may be impaired.

- ▶ Drive on carefully.
- ▶ Have the vehicle checked immediately at a qualified specialist workshop.

If you are uncertain regarding the operational safety of your vehicle, park the vehicle safely as soon as possible. Inform a qualified specialist workshop.

The on-board computer will show only messages and warnings from certain systems on the display. You should therefore make sure your vehicle is operating safely at all times.

You can find an overview of the indicator and warning lamps on the instrument cluster in "At a glance".

Overview of the instrument cluster

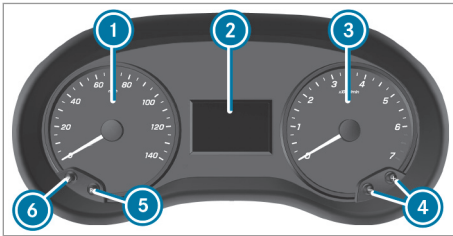

Instrument cluster (vehicles without steering wheel buttons)

- ① Speedometer
- ② Multifunction display
- ③ Tachometer
- ④ Set the instrument lighting, change values or settings, scroll through lists
- ⑤ Selects a submenu or resets values
- ⑥ Selects the menu or display

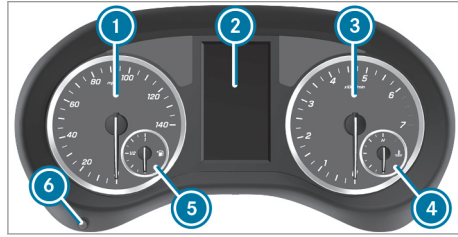

Instrument cluster (vehicles with steering wheel buttons)

- ① Speedometer
 - ② Multifunction display
 - ③ Tachometer
 - ④ Coolant temperature display
 - ⑤ Fuel level
- Fuel filler flap location : the fuel filler cap is on the left
- ⑥ Adjusts the instrument lighting

Speedometer

Vehicles with steering wheel buttons:

In vehicles with Active Distance Assist DISTRONIC, there are illuminated segments on the speedometer dial.

These segments show you what speed range is available:

- Variable limiter activated (→ page 115)
The segments light up from the start of the scale to the selected limit speed.
- Active Distance Assist DISTRONIC switched on (→ page 116)
One or two segments light up in the saved speed range.
- Active Distance Assist DISTRONIC detects a vehicle in front.
The segments light up from the speed of the vehicle in front up to the saved speed.

You can show the speed as a digital speedometer on the display as well.

If you change your vehicle's wheel size, check its assignment to the wheel size group (→ page 218). If the assignment changes without recoding the control units in the vehicle, the speedometer will not display the speed accurately. The current vehicle speed may then be higher than the speed shown by the speedometer. Driving and driving safety systems may then be operationally impaired or may detect a malfunction and switch themselves off.

In some countries, an audible signal will sound and/or a message will appear on the display when the vehicle reaches the maximum speed permitted by law, e.g. at 75 mph (120 km/h).

Tachometer

I NOTE Engine damage due to maximum engine speed being exceeded

If the maximum permissible engine speed is exceeded, the engine may be damaged.

▶ Avoid driving in the red speed range (danger zone).

When the red mark is reached, the fuel supply will be interrupted to protect the engine.

Outside temperature display

You should pay special attention to road conditions when temperatures are around freezing point.

Bear in mind that the outside temperature display indicates the measured air temperature and not the road surface temperature.

The outside temperature is displayed on the multifunction display (→ page 140).

Changes in the outside temperature will be displayed after a short delay.

Coolant temperature display

A WARNING Risk of burns when opening the hood

If you open the hood when the engine has overheated or when there is a fire in the engine compartment, the following situations may occur:

- You could come into contact with hot gases.
- You could come into contact with other hot, escaping operating fluids.

▶ Before opening the hood, allow the overheated engine to cool down.

▶ In the event of a fire in the engine compartment, keep the hood closed and call the fire service.

In vehicles without steering wheel buttons, you can show the coolant temperature on the display (→ page 142).

In vehicles with steering wheel buttons, there is an analog coolant temperature display on the instrument cluster's tachometer.

During normal driving and if the coolant level is correct, the display is permitted to rise to the following temperature:

- Vehicles with front-wheel drive: up to 230°F (110°C)
- Vehicles with rear-wheel drive: up to 248°F (120°C)

Overview and operation of the on-board computer (vehicles without steering-wheel buttons)

A WARNING Risk of distraction from information systems and communications equipment

If you operate information and communication equipment integrated in the vehicle when driving, you will be distracted from the traffic situation. This could also cause you to lose control of the vehicle.

- ▶ Only operate this equipment when the traffic situation permits.
- ▶ If you cannot be sure of this, stop the vehicle whilst paying attention to road and traffic conditions and operate the equipment with the vehicle stationary.

You must observe the legal requirements for the country in which you are currently driving when operating the on-board computer.

A WARNING Risk of accident and injury during intervention by the steering wheel

If you reach through the steering wheel to operate the adjustment knobs while driving, you could lose control of the vehicle.

- ▶ Use the adjustment knobs only when the vehicle is at a standstill.
- ▶ Do not reach through the steering wheel while driving.

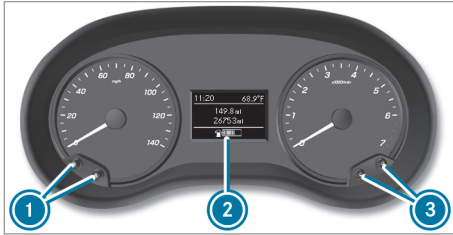

- ① Ⓜ and Ⓡ buttons
- ② Multifunction display
- ③ + and - buttons

If you turn the key to position ① in the ignition lock, the on-board computer will be activated.

If you remove the key, then quickly re-insert it and turn it to position ①, the on-board computer and instrument cluster will not be activated.

You can control the display messages and settings in the on-board computer with buttons ① and ③ on the instrument cluster.

Buttons on the instrument cluster

Ⓜ	<p>Press briefly:</p> <ul style="list-style-type: none"> • Selects the menu or display • In the Settings menu: exits the submenu without adopting the last setting and returns to the main menu
Ⓜ	<p>Press and hold:</p> <ul style="list-style-type: none"> • Returns to the standard display or the Distance menu without adopting the last setting
Ⓡ	<p>Press briefly:</p> <ul style="list-style-type: none"> • Selects a submenu or function • Confirms the selected entry on the list or the display, or confirms the setting

Ⓡ	<p>Press and hold:</p> <ul style="list-style-type: none"> • Resets the trip distance and trip computer values • In the main menu of the Settings menu, resets to factory settings • In the Settings menu, resets values and returns to the main menu
+ -	<ul style="list-style-type: none"> • Sets the instrument lighting (not in the Settings menu) • Scroll through lists • Change values or settings

Overview and operation of the on-board computer (vehicles with steering-wheel buttons)

⚠ WARNING Risk of distraction from information systems and communications equipment

If you operate information and communication equipment integrated in the vehicle when driving, you will be distracted from the traffic situation. This could also cause you to lose control of the vehicle.

- ▶ Only operate this equipment when the traffic situation permits.
- ▶ If you cannot be sure of this, stop the vehicle whilst paying attention to road and traffic conditions and operate the equipment with the vehicle stationary.

You must observe the legal requirements for the country in which you are currently driving when operating the on-board computer.

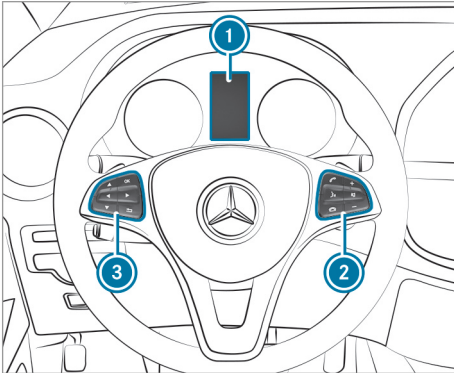









- ① Display
- ② Right control panel
- ③ Left control panel

If you turn the key to position **1** in the ignition lock, the on-board computer will be activated.



You can control the displays and the settings on the on-board computer using the steering-wheel buttons on left control panel **③**.

You can use the steering-wheel buttons on right control panel **②** to control the functions of the audio system and switch on the voice control function of the navigation system (see the separate Operating Instructions).

Steering wheel buttons

Left control panel on the steering wheel	
 	<ul style="list-style-type: none"> Call up the menu bar on the display Select a menu
 	<p>Press briefly</p> <ul style="list-style-type: none"> Scroll through lists Select a submenu or function In the Audio menu, open the track or station list and select a station or audio track In the Telephone menu, switch to the telephone book and select a name or a telephone number.
Right control panel on the steering wheel	
	<ul style="list-style-type: none"> Make or accept a call Switch to the redial memory
	<ul style="list-style-type: none"> Reject or end a call Exit the telephone book or redial memory
 	<ul style="list-style-type: none"> Adjust the volume



Left control panel on the steering wheel

 	<p>Press and hold</p> <ul style="list-style-type: none"> Quickly scroll through all lists In the Audio menu, select a station or audio track using rapid scroll In the Telephone menu with the telephone book open, start rapid scroll.
	<ul style="list-style-type: none"> Confirm display messages In all menus, confirm the selected entry on the list or the display In the Audio menu, stop the station search function In the Telephone menu, switch to the telephone book and start dialing for selected numbers

	<p>Press briefly</p> <ul style="list-style-type: none"> Back Hide display messages In the Audio menu, exit the track or station list Exit the telephone book or redial memory Vehicles with navigation system: switch off voice control for navigation (see the manufacturer's operating instructions)
---	---

	<p>Press and hold</p> <ul style="list-style-type: none"> Call up the standard display in the Trip menu
---	---

Right control panel on the steering wheel

-  • Vehicles with navigation system: switch on the voice control function of the navigation system (see the manufacturer's operating instructions)
-  • Switch the sound on/off



The audio equipment, telephone operation and voice control using the steering-wheel buttons on the right control panel work only with a Mercedes-Benz audio or navigation system. If you are using an audio or navigation system from another manufacturer, the described functions may be restricted or may not be available at all.

Overview of what is shown on the multifunction display

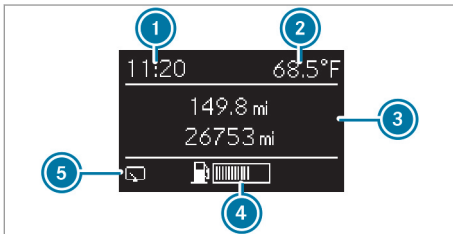
Multifunction display (vehicles without steering wheel buttons)



Multifunction display (example)



- ① Time
 Cruise control (→ page 115)
- ② Constant display: outside temperature or speed
75 mph (120 km/h)! (for certain countries only) Maximum permitted speed exceeded
- ③ Display section for display messages, menus and menu bar
- ④ Fuel level
Fuel filler flap location indicator : the fuel filler cap is on the left
- ⑤  Rear window wiper (→ page 86)



Display section ③ shows the selected menu or submenu as well as display messages.

Multifunction display (vehicles with steering wheel buttons)





Multifunction display (example)

- ① Time
- ②  Active Brake Assist (→ page 113)
 Active Parking Assist (→ page 125)
- ③ Constant display: outside temperature or speed (→ page 148)
75 mph (120 km/h)! (for certain countries only) Maximum permitted speed exceeded
- ④ Menu bar
Outside temperature (only if header ⑩ shows the additional speedometer)
- ⑤ Comfort display (→ page 104)
- ⑥ Transmission position (→ page 104)
- ⑦ Status area
- ⑧ Display section for display messages, menus and menu bar
- ⑨ Header

You can call up menu bar ④ in the display section by pressing the  or  steering-wheel button. It will automatically disappear again after a few seconds.

Display section ⑨ shows the selected menu or submenu as well as display messages.

In status area ⑧, the multifunction display can show the status of the following driving systems:

-  ATTENTION ASSIST (→ page 127)
-  Lane Keeping Assist (→ page 129)
-  Cruise control (→ page 115)

 Rear window wiper (→ page 86)

Setting the instrument lighting

⚠ WARNING Risk of accident and injury during intervention by the steering wheel

If you reach through the steering wheel to operate the adjustment knobs while driving, you could lose control of the vehicle.

- ▶ Use the adjustment knobs only when the vehicle is at a standstill.
- ▶ Do not reach through the steering wheel while driving.



Brightness control (example: vehicle with steering-wheel buttons)

The displays on the instrument cluster are illuminated during the day. A dimming function is not possible in daylight.

In vehicles with steering-wheel buttons, the light sensor on the instrument cluster automatically controls the brightness of the display lighting.

When the light has been switched on, the brightness control is influenced by the ambient light. You can then adjust the brightness of the instrument lighting and the display lighting as well.

Vehicles without steering-wheel buttons:

- ▶ Press the **+** or **-** button on the instrument cluster.
- ⓘ If the **Settings** menu has been selected on the on-board computer, it will not be possible to adjust the display brightness.

Vehicles with steering-wheel buttons:

- ▶ Turn brightness control **1** on the instrument cluster.

Overview of menus on the on-board computer

Vehicles without steering wheel buttons

Press the **⊖** button on the instrument cluster to scroll through the menus.

You will see the **Settings** menu only if the vehicle is stationary.

If you scroll forwards in the **Settings** menu using the **Ⓡ** button, the settings for the previous submenu or the previous function will be copied over.

If you press the **⊖** button in a submenu, the submenu or function will be exited without the setting being adopted.

You can find further operating information in "Overview and operation of the on-board computer" (→ page 137).

Depending on the vehicle equipment, you can call up the following menus, displays or functions:

- Display showing trip distance and total distance (→ page 142)
- Trip computer display (→ page 142)
- Display showing current range
- Display showing current fuel consumption (→ page 142)
- Digital speedometer
- Display showing coolant temperature (→ page 142)
- Display showing display messages in the message memory (→ page 235)

The following menus, displays and functions will also be displayed when the vehicle is stationary:

- Display showing next service due date (→ page 175)
- Electronic check on the engine oil level (→ page 178)
- Tire pressure monitoring system restart (→ page 209)
- The **Settings** menu for adjusting or activating and deactivating driving and driver assistance systems as well as display options (→ page 143)

Vehicles with steering wheel buttons

Use the **◀** or **▶** steering-wheel button to show the menu bar and scroll through the menus.

Use the **▼** or **▲** steering-wheel button to scroll through their submenus and functions.

You can find further operating information in "Overview and operation of the on-board computer" (→ page 138).



Depending on the vehicle equipment, you can call up the following menus:

- **Trip** menu (→ page 145)
- **Navi** menu (navigation instructions) (→ page 146)
- **Audio** menu (→ page 147)
- **Telephone** menu (→ page 147)
- **DriveAssist** menu (→ page 144)
- **Service** menu (→ page 144)
- **Settings** menu (→ page 148)

Menus and submenus (vehicles without steering wheel buttons)



Calling up the distance menu

Use the buttons on the instrument cluster.

- ▶ **To display the distance:** press and hold the  button until the display shows the odometer for the trip distance and the total distance.
- ▶ **To reset the trip distance:** press and hold the  button until the trip distance is reset to 0.0.

Trip computer menu

Use the buttons on the instrument cluster.

- ▶ **To display:** press the  button to select the trip computer display. The values displayed relate to those measured since the trip computer was last reset. The following values will be displayed:
 - Distance
 - Length of journey
 - Average fuel consumption
 - Average speed
- ▶ **To reset values:** press and hold the  button until all values are reset.

The trip computer will automatically be reset if the value exceeds 9999 hours or 99,999 mi (99,999 km).

Current fuel consumption menu

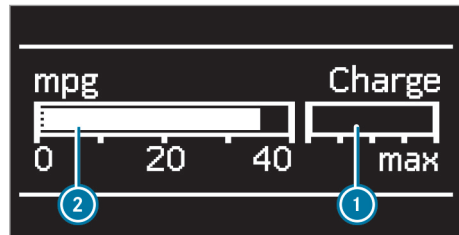

Current fuel consumption menu (example)

- ① Recuperation display
- ② Current fuel consumption

▶ Press the  button to select the fuel consumption bar display.

Recuperation display ① shows whether and, if so, how much kinetic energy is being transformed into electric current whilst the vehicle is coasting. The recuperated energy is then stored in the starter battery. Recuperation display ① is dependent on the engine installed and is therefore not available in all vehicles.

Coolant temperature menu

⚠ WARNING Risk of burns when opening the hood



If you open the hood when the engine has overheated or when there is a fire in the engine compartment, the following situations may occur:

- You could come into contact with hot gases.
- You could come into contact with other hot, escaping operating fluids.

▶ Before opening the hood, allow the overheated engine to cool down.

▶ In the event of a fire in the engine compartment, keep the hood closed and call the fire service.

Use the buttons on the instrument cluster.

- ▶ Press the  button to select the coolant temperature bar display . During normal driving and if the coolant level is correct, the display is permitted to rise to the letter **H**.

Settings menu

Requirements:

- The vehicle is stationary.

Use the buttons on the instrument cluster to operate the on-board computer.

Introduction

- ▶ **To display the Settings menu:** use the \ominus button to select the **Settings** menu.

Use the \odot button to scroll through the menu and select its submenus or functions successively.

If you press the \ominus button in a submenu, the submenu or function will be exited without the setting being adopted.

Depending on the equipment, the following is possible:

- Setting the language of the display messages and displays
- Switching ESP® on/off (→ page 111, 112)
- Setting the sensitivity of the rain sensor
- Switching ATTENTION ASSIST on/off (→ page 128)
- Setting the unit for distance, consumption and speed displays
- Setting the time and date

- ▶ **To reset to factory settings:** turn the key to position **1** in the ignition lock and, in the **Settings** menu, press and hold the \odot button for at least five seconds.

For safety reasons, not all functions will be reset.

Setting the display language

- ▶ Press \odot to select the **Language** submenu. The display will show the current language selection.
- ▶ Use the \oplus or \ominus button to select a language.
- ▶ Press the \odot button to confirm. The next submenu will be shown on the display.

Setting the sensitivity of the rain sensor

- ▶ Press the \odot button to select the **Rain Sensor** submenu. The display will show the current sensitivity setting.

- ▶ Use the \oplus or \ominus button to select the **Low**, **Standard** or **High** setting. This setting controls the rain sensor's sensitivity to precipitation. This results in the windshield wipers wiping more or less often at the same precipitation intensity.
- ▶ Press the \odot button to confirm. The next submenu will be shown on the display.
- ① You can find further information under "Windshield wipers" (→ page 85).

Selecting the permanent display function For all countries except the United Kingdom:

Using the **Permanent Display** function, you can switch the header of the display between outside temperature and speed (additional speedometer).

When the display shows the speed in the header, the outside temperature is shown with the odometers.

The additional speedometer unit in the header is always the inverse of the speedometer unit.

- ▶ Press the \odot button to select the **Permanent Display** submenu. The display will show the current setting.
- ▶ Change the setting by pressing the \oplus or \ominus button.
- ▶ Press the \odot button to confirm. The next submenu will be shown on the display.

Selecting the unit of measurement for distance

You can select whether the display shows some information in miles or kilometers.

- ▶ Press the \odot button to select the **Distance Unit** submenu. The display will show the current setting.
- ▶ Change the setting by pressing the \oplus or \ominus button.
- ▶ Press the \odot button to confirm. The display will show the next submenu or the **Settings** menu again.

The selected unit of measurement for distance applies to the following displays:

- Digital speedometer
- Total distance and trip distance
- Trip computer
- Range
- Current consumption

- Cruise control
- Service intervals

Setting the time and date

- ▶ Press the **(R)** button to select the time and date display.
 - ▶ Use the **(+)** or **(-)** button to set the hours and press **(R)** to confirm.
 - ▶ Use the **(+)** or **(-)** button to set the minutes and press **(R)** to confirm.
 - ▶ Use the **(+)** or **(-)** button to set the day and press **(R)** to confirm.
 - ▶ Use the **(+)** or **(-)** button to set the month and press **(R)** to confirm.
 - ▶ Use the **(+)** or **(-)** button to set the year and press **(R)** to confirm.
- The display shows the **Settings** menu again.

Menus and submenus (vehicles with steering-wheel buttons)

Service menu

Overview



- ▶ Use the **(◀)** or **(▶)** button to select the **Service** menu.

Depending on the equipment, you have the following options in the Service menu:

- Calling up display messages in the message memory (→ page 235).
- Checking the tire pressure electronically or restarting the tire pressure monitoring system (→ page 209).
- Calling up the service due date (ASSYST PLUS) (→ page 175)

Assistance menu

- ▶ Use the **(◀)** or **(▶)** button to select the **DriveAssist** menu.

Depending on the vehicle's equipment, you have the following options on the **DriveAssist** menu:

- Displaying the status overview
- Showing the assistant display for Active Brake Assist (→ page 113) or Active Distance Assist DISTRONIC (→ page 120).
- Switching ESP® on/off (→ page 111, 112).
- Switching Active Brake Assist on/off (→ page 115).
- Setting the sensitivity of ATTENTION ASSIST (→ page 128)
- Switching Blind Spot Assist on/off (→ page 129)
- Setting the sensitivity of Lane Keeping Assist (→ page 130)

Status overview

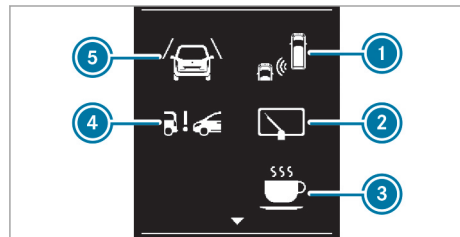

Status overview (example)

- 1 Blind Spot Assist switched on and active
- 2 Rear window wiper switched on
- 3 ATTENTION ASSIST switched on
- 4 Distance warning function of Active Brake Assist switched on
- 5 Lane Keeping Assist switched on and ready for use

- ▶ Use the **(▼)** or **(▲)** button to select the overview.

- ▶ Press the **(OK)** button.

The status overview shows only the symbols of the driving systems or driving safety systems that have been switched on.

The symbols for Blind Spot Assist and Lane Keeping Assist may vary depending on the system status:

- If the symbol for Blind Spot Assist **1** does not show any radar waves between the two vehicles, Blind Spot Assist has been switched on but is not ready for use.

For more information, see "Blind Spot Assist" (→ page 129).

- If the symbol for Lane Keeping Assist ⑤ shows the lane marking as a broken line, Lane Keeping Assist has been switched on but is not ready for use.

For more information, see "Lane Keeping Assist" (→ page 129).

- ① In addition, you can display the evaluation of ATTENTION ASSIST or the attention level in the status overview (→ page 127).

Calling up displays on the Trip menu

Displaying the range and current fuel consumption

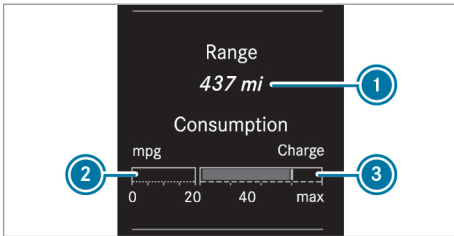

- ▶ Use the ◀ or ▶ button to select the Trip menu.
- ▶ Use the ▼ or ▲ button to select range ① and consumption ②.

Approximate range ① is determined by the current driving style and fuel supply. If there is only a small amount of fuel left in the fuel tank, the display will show a vehicle being refueled  instead of the approximate range.

Recuperation display ③ shows whether and, if so, how much kinetic energy is being converted to electric energy while the vehicle is coasting. The recuperated energy is then stored in the starter battery. Recuperation display ③ is dependent on the engine installed and is therefore not available in all vehicles.

Displaying trip computer "From start" or "From reset"

- ▶ Use the ◀ or ▶ button to select the Trip menu.

- ▶ Use the ▼ or ▲ button to select the From Start or From Reset submenu.

The following values will be displayed:

- Distance
- Length of journey
- Average fuel consumption
- Average speed

The values in the From Start submenu relate to those measured since the start of the journey. The values in the From Reset submenu relate to those measured since the submenu was last reset.

The From Start trip computer will automatically be reset under the following conditions:

- The ignition has been switched off for longer than four hours.
- A time of 999 hours has been exceeded.
- A distance of 9999 mi (9999 km) has been exceeded.

The From Reset trip computer will automatically be reset under the following conditions:

- A time of 9999 hours has been exceeded.
- A distance of 99,999 mi (99,999 km) has been exceeded.

Displaying the digital speedometer

- ▶ Use the ◀ or ▶ button to select the Trip menu.
- ▶ Select the digital speedometer using the ▼ or ▲ button.

The following will be shown on the display:



- Gearshift recommendation:
Vehicles with automatic transmission
- Digital speedometer

Resetting values

The values of the following functions can be reset:



- Trip distance
- "From start" trip computer
- "From reset" trip computer

- ▶ Use the ◀ or ▶ button to select the Trip menu.
- ▶ Use the ▼ or ▲ button to select the function to be reset.
- ▶ Press the OK button.

- ▶ Use the  button to select **Yes** and confirm with the  button.

Navigation menu

In the **Navi** menu, the display shows the navigation instructions from the audio and/or navigation system. Further information on the audio and/or navigation system can be found in the separate operating instructions.

- ▶ Switch the audio and/or navigation system on (see separate operating instructions).
- ▶ Use the  or  button to select the **Navi** menu.
- ▶ Press the  button to confirm.

Route guidance not active

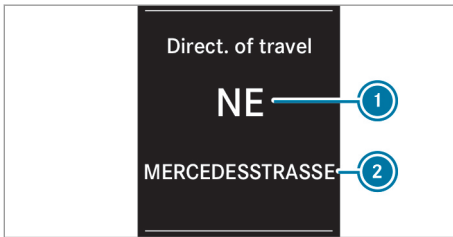

- ① Direction of travel
- ② Name of current road

Route guidance active

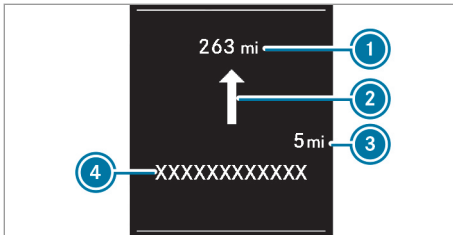

No change of direction announced

- ① Distance to the next destination
- ② Change-of-direction symbol
- ③ Distance to the next change of direction
- ④ Name of current road

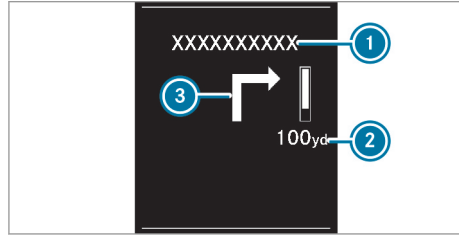

Change of direction announced without lane recommendation

- ① Road to which the change of direction leads
- ② Distance to the change of direction and distance indicator graphic
- ③ Change-of-direction symbol

If you need to make a change of direction, you will see a dynamic bar as a distance indicator graphic above distance information ②.

This bar reduces in size from bottom to top as you approach the announced change of direction. When the distance indicator no longer shows a bar, this means you have reached the point at which you are to change direction.

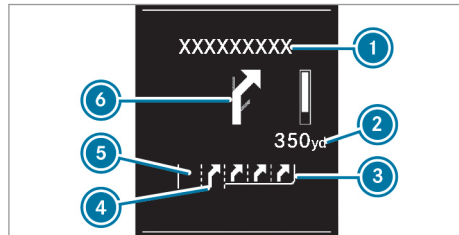

Change of direction announced with lane recommendation

- ① Road to which the change of direction leads
- ② Distance to the change of direction and distance indicator graphic
- ③ Recommended lane and new lane during a change of direction
- ④ Possible lane
- ⑤ Lane not recommended
- ⑥ Change-of-direction symbol

If the digital map contains the corresponding data, lane recommendations for upcoming changes of direction can be displayed in the case of multi-lane roads. New lanes may be added during the change of direction.

Lane not recommended ⑤: in this lane, you will not be able to complete the next change of direction without changing lane.

Possible lane ④: only in this lane will you be able to make the next change of direction.

Recommended lane ③: in this lane, you will be able to complete both the next change of direction and the one after that.







The following additional navigation status displays are possible:

- **New Route... or Calculating Route...**
A new route is being calculated.
- **Road Not Mapped**
The vehicle's position is within the area of the digital map, but the road is not known, e.g. it may be an unpaved road.
- **No Route**
No route could be calculated to the selected destination.
- 
You have reached the destination or an intermediate destination.



Audio menu

Selecting a radio station

The station is displayed with the station frequency or station name. The memory preset is displayed along with the frequency band only if the station has been stored.

- ▶ Switch on the audio system and select the radio function (see the separate operating instructions).
- ▶ Use the  or  button to select the **Audio** menu.
The display will show the station currently selected.
- ▶ **To select a stored station:** briefly press the  or  button.
- ▶ **To select a station from the station list:** press and hold the  or  button.











If no station list is received:

- ▶ **To select a station using the station search function:** press and hold the  or  button.

Operating data storage media

Depending on the multimedia system, you can play back audio files from different audio sources,

such as an SD card, a USB storage device or a Bluetooth® audio device.

- ▶ Switch on the multimedia system and select the audio source (see the separate operating instructions).
- ▶ Use the  or  button to select the **Audio** menu.
- ▶ **To open the track list:** press the  or  button.
- ▶ **To select the next or previous track on the track list:** briefly press the  or  button.
- ▶ **To select a track from the track list using rapid scroll:** press and hold the  or  button until the desired track is reached.
If you press and hold the  or  button, the rapid scroll speed will increase after a short time. Not all audio sources support this function.

If the corresponding track information is stored on the data storage medium, the display may show the following:

- Track number
- Artist and/or track name
- Folder name

If an external audio source has been connected via the AUX connection, no track information is displayed.

Telephone menu

⚠ WARNING Risk of distraction from information systems and communications equipment

If you operate information and communication equipment integrated in the vehicle when driving, you will be distracted from the traffic situation. This could also cause you to lose control of the vehicle.

- ▶ Only operate this equipment when the traffic situation permits.
- ▶ If you cannot be sure of this, stop the vehicle whilst paying attention to road and traffic conditions and operate the equipment with the vehicle stationary.

When using the phone, you must observe the legal requirements for the country in which you are currently driving.

- ▶ Switch on the audio system (see the separate operating instructions).
- ▶ Switch on the mobile phone (see the separate operating instructions from the manufacturer).
- ▶ Establish a Bluetooth® connection between the mobile phone and the audio system (see the separate operating instructions).
- ▶ Use the ◀ or ▶ button to select the **Telephone** menu.

The display will show one of the following messages:

- The name of the mobile phone network provider or **Phone READY**:
The mobile phone has found a network and is ready to receive.
- **Phone No Service**:
No network is available or the mobile phone is searching for a network.
- **Bluetooth ready**:
You have not yet established a Bluetooth® connection between the mobile phone and the audio system.

You can obtain further information about suitable mobile phones and connecting via Bluetooth®:

- At a Mercedes-Benz Commercial Van Center
- On the Internet at <https://www.mercedes-benz.com/connect>

Accepting a call

- ▶ Press the ☎ button on the steering wheel.

If someone calls you when you are in the **Telephone** menu, a corresponding message will appear on the display.

Rejecting or ending a call

- ▶ Press the ☎ button on the steering wheel.

Dialing a number from the telephone book

- ▶ Use the ◀ or ▶ button to select the **Telephone** menu.
- ▶ Press the ▼, ▲ or OK button to switch to the telephone book.
- ▶ Use the ▼ or ▲ button to scroll through the names.
If you press and hold the button for longer than one second, the names in the telephone book will be scrolled through rapidly.

or

- ▶ Press and hold the ▼ or ▲ button for longer than five seconds.
Rapid scrolling – the name that starts with the next letter or the previous letter in the alphabet is displayed.
Rapid scrolling will stop when you release the button or reach the end of the list.

If only one telephone number is stored for a name:

- ▶ Press the ☎ or OK button.
Dialing starts.

If several telephone numbers are stored for a name:

- ▶ Press the ☎ or OK button.
The phone numbers will be displayed.
- ▶ Press the ▼ or ▲ button to select a telephone number.
- ▶ Press the ☎ or OK button.
Dialing starts.
- ▶ **To exit the telephone book:** press the ☎ or ↩ button.

Redialing

The on-board computer will save the last names or numbers dialed in the redial memory.

- ▶ Use the ◀ or ▶ button to select the **Telephone** menu.
- ▶ Press the ☎ button to switch to the redial memory.
- ▶ Press the ▼ or ▲ button to select a name or telephone number.
- ▶ Press the ☎ or OK button.
Dialing starts.
- ▶ **To exit the redial memory:** press the ☎ or ↩ button.

Settings menu

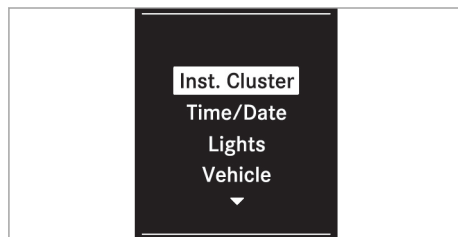

Settings menu (example)

Depending on the vehicle's equipment, you have the following options on the **Settings** menu:

- In the **Instrument Cluster** submenu, changing the display options
- In the **Time/Date** submenu, changing the time and date
- In the **Light** submenu, changing the settings for exterior and interior lighting
- In the **Vehicle** submenu, switching vehicle functions on/off or adjusting them
- Resetting the settings to **Factory Setting**

▶ Use the  or  button to select the **Settings** menu.

Instrument Cluster submenu

▶ Use the  or  button to select the **Instrument Cluster** submenu.

▶ Press the  button.

In the **Instrument Cluster** submenu, you have the following options depending on the equipment:

- Changing the unit of measurement for distance
- Changing the display language.
- Selecting the permanent display in the header of the display

▶ Use the  or  button to select the desired function.

▶ Choose a setting.

Time/Date submenu

▶ Use the  or  button to select the **Time/Date** submenu.

▶ Press the  button.

▶ Use the  or  button to select the desired function.

▶ Press the  button.

▶ Choose a setting.

▶ Press the  button to confirm.

Light submenu

▶ Use the  or  button to select the **Light** submenu.

▶ Press the  button.

In the **Light** submenu, you have the following options depending on the equipment:

- Activating/deactivating the surround lighting and switch-off delay time of the exterior lighting

An activated **Surround Lighting**: function works only in the dark and if the light switch is in the **AUTO** position.

- Activating/deactivating the switch-off delay time of the interior lighting

▶ Choose a setting.

Vehicle submenu

▶ Use the  or  button to select the **Vehicle** submenu.

▶ Press the  button.

In the **Vehicle** submenu, you have the following options depending on the equipment:

- Setting the sensitivity of the rain sensor
You can find further information under "Windshield wipers" (→ page 85).
- Switching the automatic door lock on/off
You can find further information under "Automatic locking mechanism" (→ page 46).
- Activating/deactivating the acoustic locking verification signal

▶ Choose a setting.

Resetting the settings to factory settings

▶ Press the  or  button to select **Factory Setting**.

▶ Press the  button.

The **Reset All Settings?** function will be displayed.

▶ Press the  or  button to select **Yes**.

▶ Press the  button.

For safety reasons, not all functions will be reset. The **Limit Speed (Winter Tires)** function of the permanent limiter can be adjusted only in the **Vehicle** submenu.

Information about Mercedes PRO (Mercedes me)

Mercedes-Benz Vans vehicles support the following telematics solutions depending on what is selected:

- Mercedes PRO
- Mercedes me

When you have registered and logged in with a user account to the Mercedes PRO Portal or Mercedes me Portal, then services and offers from Mercedes-Benz Vans will be available to you.

Availability of Mercedes PRO is country-dependent. You can check the availability of Mercedes PRO in your country in the Mercedes PRO Portal: <http://www.mercedes.pro>

Availability of Mercedes me is country-dependent. You can check the availability of Mercedes me in your country in the Mercedes me Portal: <http://www.mercedes.me>

For more information on Mercedes PRO or Mercedes me contact an authorized Mercedes-Benz Center or visit the Mercedes PRO Portal or Mercedes me Portal.

Information about Mercedes PRO connect (Mercedes me connect)

Mercedes PRO connect or Mercedes me connect is the connectivity product from Mercedes-Benz that intelligently connects your vehicle with your smartphone, your tablet or your PC. You can then call up diverse information about your vehicle at any time, for example, or control specific vehicle functions remotely.

Amongst others, Mercedes PRO connect or Mercedes me connect provide the following services:

- Breakdown Management (breakdown assistance call button)
In the event of a breakdown, you can use the breakdown assistance call button in the overhead control panel to make a call to the Mercedes-Benz Customer Center (→ page 150).
- Mercedes-Benz Emergency call system (SOS button)

Use the  button (SOS button) in the overhead control panel to make a call to the

Mercedes-Benz emergency call center (→ page 150).

- Accident Recovery
Accident Recovery is available for you as a supplement to the Mercedes-Benz emergency call system. If desired, at the conclusion of an emergency call, your call is forwarded to the Mercedes-Benz Customer Center, so you can have your vehicle towed away to an authorized Mercedes-Benz Center, for example (→ page 150).

The Mercedes-Benz Customer Center and the Mercedes-Benz emergency call center are available for you around the clock for the use of the services. Observe the legal requirements for the country in which you are staying.

To use the services in your vehicle, the following conditions must be met:



- Your vehicle is in an area with sufficient GSM network coverage.
- The ignition is switched on.

For further information about Mercedes PRO and Mercedes PRO connect and the range of services offered, please refer to the Mercedes PRO supplement at: <https://www.mercedes.pro>

For further information on Mercedes me and Mercedes me connect and the range of services offered, please refer to the Mercedes me supplement at: <https://mercedes.me>

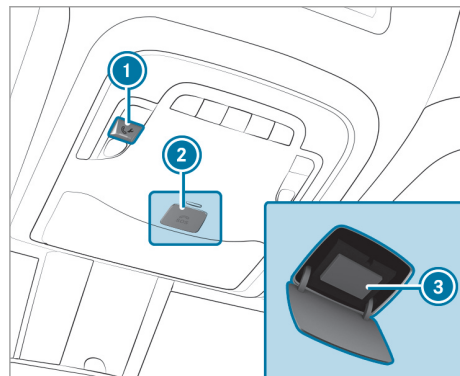
Making a call via the overhead control panel



- ① Breakdown assistance call button
- ② The cover for the  button (SOS button)
- ③  button (SOS button)

Making a breakdown assistance call

- ▶ Press button ①.

Making an emergency call

- ▶ Briefly press the cover on SOS button ② to open it.
- ▶ Press and hold SOS button ③ for at least one second.

An emergency call can still be triggered when a breakdown assistance call is active. This has priority over all other active calls.

Information on the breakdown assistance call via the overhead control panel

A call to the Mercedes-Benz Customer Center using the breakdown assistance button has been initiated via the overhead control panel:

In the event of a breakdown, you will get support:

- A qualified technician carries out repairs on site and/or the vehicle will be towed to the nearest authorized Mercedes-Benz Center
- You may be charged for these services.

Data is transmitted during the connection to the Mercedes-Benz Customer Center (→ page 151).

Giving permission for data transfer

Requirements:

- There is an active breakdown assistance call (→ page 150).

A message appears in the instrument cluster.

- ▶ Confirm the prompt.
Relevant identification data is transmitted automatically.

Transmitted data during a service call

In certain countries you must confirm the data transfer.

The following requirements must be met for data transmission:

- The ignition is switched on.
- The necessary data transmission technology is supported by the mobile network provider.
- A sufficient mobile phone connection quality is provided.

The data transferred when calling depends on the services activated and the type of call made:

- General information about the vehicle
- Accident and breakdown assistance
- Service appointment agreement

The following data is transmitted if the data protection query has been confirmed in the multimedia system or in the instrument cluster:

- Vehicle identification number
- Reason for the initiation of the call
- Confirmation of the data protection prompt

If a call is made for a service appointment via the service reminder, the following data may be transmitted:

- Current mileage and maintenance data

If accident and breakdown assistance is called via the voice control system, and the data protection query has been confirmed, the following data can also be called up from the vehicle by the Mercedes-Benz Customer Center:

- Current vehicle location

The following data is transmitted if the data protection query has been declined on the instrument cluster:

- Reason for the initiation of the call
- Rejection of the data protection prompt

Notes on operating safety

⚠ WARNING Risk of distraction from information systems and communications equipment

If you operate information and communication equipment integrated in the vehicle when driving, you will be distracted from the traffic situation. This could also cause you to lose control of the vehicle.

- ▶ Only operate this equipment when the traffic situation permits.
- ▶ If you cannot be sure of this, stop the vehicle whilst paying attention to road and traffic conditions and operate the equipment with the vehicle stationary.

You must observe the legal requirements for the country in which you are currently driving when operating the multimedia system.

Anti-theft protection

This device is equipped with technical provisions to protect it against theft. Further information on protection against theft can be obtained from an authorized Mercedes-Benz Center.

Operating temperature

Observe the following temperature range for the device:

- Operating temperature: (-25°C) to (+ 70°C)

Specifications

Wireless frequencies/ protocols	2.4 GHz @ 9.5 dBm nominal
Input voltage	From 7.5 to 18.5V
Maximum operating current	2.5A

Bluetooth® specification

Properties of the Bluetooth® technology used:

Bluetooth® version	2.0
Energy class	Class 2
Frequency range	2402 to 2480 MHz

Trademark information

© 2019 Garmin Ltd. or their subsidiaries.

Garmin® and the Garmin logo are brands from Garmin Ltd. or their subsidiaries, that are registered in the USA and other countries.

Android™ is a trademark from Google.

Inc. Apple® and the Apple logo are brands from Apple Inc., registered in the USA and other countries.

The BLUETOOTH® word trademark and logo are the property of Bluetooth SIG, Inc.

Every use of this trademark by Garmin is done under license.

HD radio technology manufactured under license from iBiquity Digital Corporation. US and foreign patents. For patents, see <http://dts.com/> patents. HD Radio, Artist Experience and the HD, HD Radio and "ARC" logos are registered trademarks or trademarks of the iBiquity Digital Corporation in the USA and/or other countries.

SiriusXM®, TuneMix™, TuneStart™ and all associated trademarks and logos are trademarks of SiriusXM Radio Inc. All Rights Reserved.

Overview and operation

Overview of the control panel

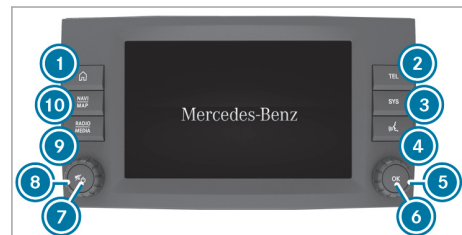

- ① Press: calls up the home screen.
- ② Press: pairs a phone or uses smart-phone functions
- ③ Press: calls up settings
- ④ Press: activates voice control
- ⑤ Turn: navigates through options on the current page
- ⑥ Press: confirms selection
- ⑦ Press: switches off the media display or mutes the sound
- ⑧ Turn: sets the volume for media, navigation announcements or telephone calls
- ⑨ Press: selects the current media source
- ⑩ Press: calls up the navigation map.

Changing the arrangement of applications on the home screen

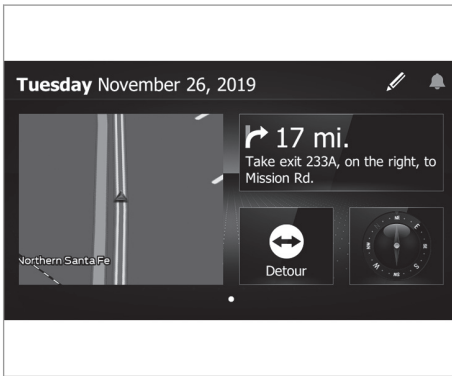

You can customize the home screen with various widgets and apps and access it at any time.

- ▶ Press on . The home screen is called up.

Adding or changing buttons

- ▶ **To assign an app to an empty button:** select an empty button.
- ▶ **To change an existing app:** hold down the app icon until the app tile selection window appears on the home screen.
- ▶ Select an app and assign it to the respective tile.

Operating the touchscreen

Tapping

- ▶ Tap on the display to select an element.

Single-finger swipe

- ▶ Draw or swipe a finger across the display to tilt or to scroll.

Calling up applications

The main menu is shown in the media display when you start the vehicle.

- ▶ Select the application by swiping and tapping, or
- ▶ **In any display:** tap on the  symbol on the touchscreen.
- ▶ Select the application by swiping and tapping.

System settings

Configuring basic settings

- ▶ Press on .

The following options are available:

- **Connected Devices:** Options for controlling connected devices that use Android Auto, Apple CarPlay® or Bluetooth® technology.
- **Phone:** Sets options for use with your smartphone
- **Navigation:** Setting options for navigation and map interaction
- **Notifications:** Defines settings for different notification types
- **Display and Language:** Defines settings for display and language
- **Sound:** Sets options for sound and volume
- **Time and Units:** Defines units of measurement used
- **About:** Displays system information, end user license agreements and advanced settings

Displaying of the E-label with conformity markings and information on legal requirements:

- ▶ Press  and select **Settings** ▶▶ **About** ▶▶ **Regulatory**.

Configuring settings for connected devices

- ▶ Press  and select **Connected Devices**.

The following options are available:

- **Bluetooth:** Sets options for connecting and configuring devices that use Bluetooth® technology
- **Android Auto:** Sets options for devices that use the Android Auto app
- **Apple CarPlay:** Sets options for devices that use Apple CarPlay®
- **Bluetooth Name::** Sets a name for a Bluetooth® connection
- **Add a device:** Starts the procedure for pairing the multimedia system with an available Bluetooth® device

Configuring smartphone and text message settings

- ▶ Press on  and select **Phone**.

The following options are available:

- **Auto Text Messages:** Sets text for messages sent automatically while driving
- **Contact Sorting:** Sets sorting method of contact names
- **Contact Display:** Sets display of contact names

Configuring navigation settings

Map settings

▶ Press on **[sys]** and select **Navigation** ▶▶
Map.

The following options are available:

- **Driving Map View:** Sets map perspective
- **Map Theme:** Determines color for the map material
- **Map Layer:** Sets the level of detail of the map
- **Installed Maps:** Specifies maps to be installed
- **Map Updates:** Defines procedure for map material updates

Guidance settings

▶ Press on **[sys]** and select **Navigation** ▶▶
Navigation Instructions.

The following options are available:

- **Calculation Mode:** Sets route calculation mode
- **Avoidances:** Sets road types to be avoided on the route
- **Custom Avoidances:** Allows you to avoid certain roads or areas
- **Voice Prompts:** Enables or disables voice prompts during navigation
- **Junction View:** Enables or disables view of upcoming junctions while driving
- **GPS Simulator:** Enables the GPS simulator to calculate and simulate routes

Traffic settings

▶ Press on **[sys]** and select **Navigation** ▶▶
Traffic.

The following options are available:

- **Traffic:** Activates traffic messages
- **Automatic Route Optimization:** Uses optimized alternative routes automatically or on request

- **Current Provider:** Sets provider from which traffic data is obtained. With the "Auto" option, the best available traffic data is automatically selected.
- **Subscriptions:** Displays list of current subscriptions for traffic data

Setting position course

▶ Press on **[sys]** and select **Navigation** ▶▶
Location History.

The following option is available:

- **Travel Data Recording:** Enables the gathering of travel information

Device and privacy settings

▶ Press on **[sys]** and select **About.**

The following options are available:

- **System Update:** Starts software update, if an update is available
- **Map Updates:** Starts or completes update for the map material
- **System Information:** Displays hardware and software version information
- **EULAs:** Displays the End User License Agreement (EULA) and software license information
- **Regulatory:** Displays E-Label with compliance designations and regulatory information.
- **Reset to Factory Defaults:** Deletes all data and resets the multimedia system to the factory settings

Configuring notification settings

▶ Press on **[sys]** and select **Notifications.**

The following options are available:

- **Incoming Phone Call:** Set to display a notification to answer or reject incoming calls
- **Missed Call:** Set to display a missed call notification
- **Ongoing Call:** Set to display a notification when a call is in progress

Configuring display and language settings

▶ Press **[sys]** and select **Display and Language.**

The following options are available:

- **Brightness:** Sets the brightness of the media display
- **Display Color Mode:** Selects day or night color mode. If you select the "Automatic" option, the multimedia system switches automatically to day or night colors depending on the time of day.
- **System Voice:** Sets the voice for the navigation announcements and other information
- **System language:** Sets the language for text
- **Keyboard:** Sets the keyboard design

Configuring sound settings

▶ Press on **sys** and select **Sound**.

The following options are available:

- **Adjust Volumes:** Sets the volumes for audible device functions.
- **Adjust Sound Quality:** Sets the level for balance, fader, bass, mid-range and treble for the media source you are using.
- **Audio Prompts:** Sets the style for audio announcements.
- **Equalizer Preset:** Defines the settings for the equalizer function.
- **Touch Sounds:** Sets the sound for the selection of symbols on the media display.

Calling up the tool menu

▶ You can call up the tool menu any time by pressing on **☰**.

The following functions are available:

- **Where Am I?:** Displays information about your current position.
- **Detour:** Starts a detour.
- **Now Playing:** Displays information about the current media track.
- **Nav Assist:** Shows upcoming exits and current location information.
- **Traffic:** Displays traffic information along your route.
- **Up Ahead:** Displays points of interest located ahead of you.
- **Quick Settings:** Options for activating or deactivating various system functions.

Navigation

Navigation overview

During the journey, the multimedia system guides you to the destination using voice messages and information on the map. Instructions for turning, exits or other directional changes are displayed in the upper section of the map.

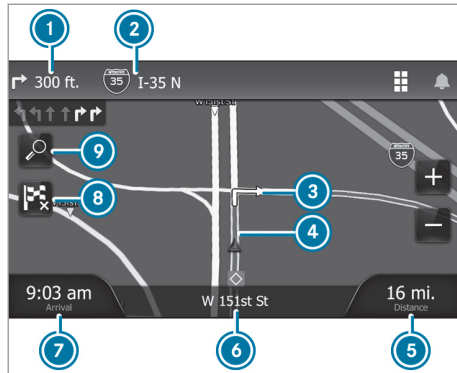

- 1 Next direction change on the route.
 - 2 Name of the street or exit that is linked to the next change of direction.
 - 3 Next direction change on the route. Arrows on the map show the positions of the next changes of direction.
 - 4 Route marked on the map.
 - 5 Estimated distance to destination.
 - 6 Name of the street on which the vehicle is located.
 - 7 Estimated time of arrival
 - 8 Stops the route
 - 9 Searches for points of interest or starts a new route
- i When you tap **5** or **7**, you can adjust the arrival time or distance information.

Destination entry

Notes on destination entry

⚠ WARNING Risk of distraction from operating integrated communication equipment while the vehicle is in motion

If you operate communication equipment integrated in the vehicle when driving, you will be distracted from the traffic situation.

This could also cause you to lose control of the vehicle.

- ▶ Only operate this equipment when the traffic situation permits.
- ▶ If you cannot be sure of this, stop the vehicle whilst paying attention to road and traffic conditions and operate the equipment with the vehicle stationary.

You must observe the legal requirements for the country in which you are currently driving when operating the multimedia system. The search menu helps to find the destination.

The following search options are available:

- To search all location information quickly, enter search terms.
- Browse or search existing points of interest by category.
- To find specific positions, e.g. addresses, intersections or geographical coordinates, use search functions.
- Location search within the vicinity of other cities or areas
- Save favorites.
- Search for previously discovered destinations again.

Results of the destination search

The results of the destination search are displayed in a list, with the nearest location at the top. You can scroll down to see more results.

Search tools

Search tools allow you to search for specific location types using prompts on the media display.

Searching for and entering destinations

Finding destinations with the search bar

You can search for specific locations in the search bar by entering a category, brand name, address or location name.



- ▶ Select  on the map.
- ▶ Select **Keyword or Address** in the search bar.
- ▶ Enter all or part of the search term. Suggested search terms are displayed below the search bar.

The following options are available:

- To search for an address near you, enter the street and house number.
- To search for an address in another city, enter the street, house number, city and state or province.
- To search for a city, enter the city and the state or province.
- To search for specific coordinates, enter the latitude and longitude.
- To search for specific businesses, enter the appropriate category, e.g. cinemas.
- To search for a business with a specific name, enter all or part of the name



- ▶ Select one of the following options.
 - ▶ To search for one of the suggested search terms, select the corresponding term.
- or
- ▶ Press **Done** for the entered terms searched for.
 - ▶ Select a destination if necessary.

Changing the search area

- ▶ Select  on the map.
- ▶ Select .
- ▶ Select one of the available options.

Searching for an address

Depending on the available map material, the sequence of steps can be different.

- ▶ Select  on the map.
- ▶ Select  if it is necessary to change the search area.
- ▶ Select **Address**.
- ▶ Follow the instructions on the media display to enter the address information.
- ▶ Select the address.

Searching for a city

Before you can search for a city, you must add the "Cities" shortcut to the search menu.

- ▶ Select  on the map.
- ▶ Select **Cities**.
- ▶ Select one of the following options.
- ▶ Select a city from the list.

or

- ▶ Enter the name of the city you are looking for and press **Done**.

Searching for an intersection

Before you can search for an intersection, you must add the "Intersections" shortcut to the search menu.



You can then search for an intersection or junction between two roads, highways or other road types.

- ▶ Select  on the map.
- ▶ Select [Intersections](#).
- ▶ Follow the instructions on the media display to enter the street information.
- ▶ Select an intersection.

Finding a destination using coordinates

Before you find a destination using coordinates, you must add the "Coordinates" shortcut to the search menu.

You can find destinations by specifying longitude and latitude.

- ▶ Select  ▶▶ [Coordinates](#) on the map.
- ▶ If required, select  ▶▶ [Coordinate Format](#).
- ▶ Press on [Change](#).
The coordinate format or date is changed.
- ▶ Enter the coordinates in longitude and latitude.
- ▶ Press on [Accept](#).

Destination search by categories

- ▶ Select  on the map.
- ▶ Select a category or choose from [Calculation Mode](#).
- ▶ Select a subcategory if necessary.
- ▶ Select a destination.

Parking the vehicle

- ▶ Select  on the map.
- ▶ Press [Select Calculation Mode](#) ▶▶ [Parking](#).
- ▶ Choose a parking space.
- ▶ Press on [Go!](#).



Displaying and deleting last destinations

Displays

The multimedia system stores a history of the last fifty destinations found.

- ▶ Select  on the map.
- ▶ Select [Recents](#).

Deleting

- ▶ Select  on the map.
- ▶ Select [Recents](#) ▶▶  ▶▶ [Clear All Recent Places](#) ▶▶ [Clear](#).



Displaying POIs

The "POI along the route" function provides information on the next POIs along the road you are traveling on, e.g. restaurants, gas stations or rest areas. If you are driving on a freeway, you can also display information and available points of interest for the nearest intersections and cities.

Displaying the next points of interest

- ▶ Select  ▶▶ [Up Ahead](#) on the map.
- ▶ Select a display from the list of possible locations for the category, exit or city.

Adjusting categories for points of interest along the route

- ▶ Select  ▶▶ [Up Ahead](#) on the map.
- ▶ Select a category.
- ▶ Select  ▶▶ [Up Ahead Options](#).

The following options are available:

- To move a POI category up or down in the list, select the arrow next to the category name
- To change a category, select the category and choose a new category from the list

- ▶ Select [Save](#).

Displaying current location information

You can use the [Where Am I?](#) function to display information about your current position.

This function is particularly useful in the following cases:

- To communicate the location in case of emergency.
- To find nearby hospitals, police stations and gas stations.

- ▶ Select  ▶▶ [Where am I?](#).
The current location information is displayed.
- ▶ Select the [EV Stations](#) category, for example.

- ⓘ Some service categories are not available in all areas. A list of locations for the selected service is displayed, with the nearest locations at the top.

- ▶ Select the desired destination.
- ▶ Select one of the following options:
- ▶ To navigate to the destination, select [Go!](#).

or

- ▶ To call the destination using the paired telephone, select **Call**.



Saving and deleting destinations

Saving

- ▶ Search for a destination (→ page 156).
- ▶ Select a destination from the search results.
- ▶ Press on **Save**.
- ▶ Enter a name and press on **Done**.



Deleting a saved destination

Deleted destinations are not restored.

- ▶ Select  ▶▶  ▶▶ **Select a Saved Place**.
- ▶ Activate the checkbox next to the destination to be deleted.
- ▶ Select **Delete**.

Adding or removing shortcut for destination entry

A shortcut can refer to a destination, a category or a search function. The "Destination entry" menu can contain up to 36 shortcut symbols.

- ▶ **To add:** select  ▶▶ **Add Shortcut** on the map.
- ▶ Select a symbol.
- ▶ **To remove:** select  ▶▶  ▶▶ **Remove Shortcut(s)** on the map.
- ▶ Select a shortcut.
- ▶ Select **Remove**.

Route

Notes on the routes

A route is a journey from your current location to one or more destinations.

The following route options are available:

- The multimedia system calculates a recommended route to your destination using the information you specify, including the route calculation mode (→ page 159) and the route options set (→ page 159).
- You can start navigation to your destination immediately with the recommended route or select an alternative route (→ page 158).
- You can add multiple intermediate destinations to the route (→ page 160).



Arrival at your destination

As you approach your destination, the multimedia system displays additional information to help you complete your route.

You will receive the following information upon arrival at your destination:

-  shows the location of the destination on the map, while a voice message informs you that you are approaching the destination.
- When you approach certain destinations, the multimedia system automatically prompts you to find a parking space. With **Yes** you can find nearby parking spaces.
- When you stop at your destination, the multimedia system automatically ends the route. If not, you can end the route by pressing **Stop**.



Starting and ending a route

- ▶ Press on .
- ▶ Select .
- ▶ Select a position.
- ▶ Select one of the following options:
- ▶ To start navigation with the recommended route, press on **Go!**.

or

- ▶ To select an alternative route, press on **Routes** and select a route. Alternative routes are shown to the left of the map.
- ▶ The navigation system calculates a route to the selected destination.

Using a map





- ▶ Press on .
- ▶ To display the desired search area, move the section of the map and use the zoom function.
- ▶ If required, select  ▶▶  to filter the displayed POIs according to category. The position marks are shown on the map.
- ▶ Select one of the following options:
- ▶ Select a position mark.

or

- ▶ Select a point on the map, e.g. a street, intersection or address.
- ▶ Press on **Go!**.

Searching for the "Home location"

If you are starting a route home for the first time, the navigation system prompts you to enter the "Home location".

- ▶ Press on .
- ▶ Select  ▶▶ **Navigating Home.**
- ▶ If required, enter the "Home position".
- ▶ **To edit the "Home location":** press .
- ▶ Select  ▶▶  ▶▶ **Change Home Location.**

Ending a route

- ▶ Select  on the map.

Selecting route options

Avoiding traffic obstructions along the route

To avoid traffic obstructions, you need traffic information.

To avoid traffic obstructions, the navigation system automatically optimizes the route. If you have deactivated this function in the traffic information settings, you can see expected traffic obstructions on the media display and avoid them independently.

- ▶ Select the  ▶▶ **Traffic options.**
- ▶ If available, select **Alternative Route to.**
- ▶ Press on **Go!**

Avoiding toll roads

The navigation system can calculate routes that bypass areas with roads requiring a fee, e.g. toll roads, toll bridges or congestion areas. If no other appropriate routes are available, the navigation system will include any toll road sections in the route.

- ▶ Press on .
- ▶ Select the options **Settings** ▶▶ **Navigation** ▶▶ **Navigation Instructions** ▶▶ **Avoidances.**
- ▶ Select **Tolls and Fees.**

Defining your own bypass criteria

Your own bypass criteria allow you to avoid certain areas or road sections. When the navigation system calculates a route, these areas and road sections are avoided unless there is no other reasonable route available.

- ▶ Press on .
- ▶ Select the options **Settings** ▶▶ **Navigation** ▶▶ **Navigation Instructions** ▶▶ **Custom Avoidances.**
- ▶ Select **Add Avoidance.**
- ▶ **To avoid a certain section of the road:** select **Avoid Road.**

- ▶ Select the starting point of the road section to be avoided.
- ▶ Select **Next.**
- ▶ Select the end point of the road section.
- ▶ Select **Next.**
- ▶ Select **Done.**
- ▶ **To avoid a specific area:** select **Avoid Area.**
- ▶ Select the upper left corner of the area to be bypassed.
- ▶ Select **Next.**
- ▶ Select the lower right corner of the area to be bypassed.
- ▶ Select **Next.**
The selected area is displayed in color.
- ▶ Select **Done.**

Deactivating and deleting your own bypass criteria

- ▶ Press on .
- ▶ Select the options **Settings** ▶▶ **Navigation** ▶▶ **Navigation Instructions** ▶▶ **Custom Avoidances.**
- ▶ Select a detour criterion.
- ▶ **To deactivate:** deselect the **Enable** checkbox.
- ▶ **To delete:** select **Delete.**

Selecting route calculation mode

- ▶ Press on .
- ▶ Select **Settings** ▶▶ **Navigation** ▶▶ **Navigation Instructions** ▶▶ **Route Preference.**

Select one of the following options for calculating routes:

- **Faster Time:** Faster routes, even if the route is longer
- **Shorter Distance:** Shorter distances, even if more time is needed
- **Less Fuel:** Fuel-efficient routes

Selecting a detour

During navigation, you can select detours for a specified distance or avoid specific roads. This function is useful if you encounter road works, closed roads or poor road conditions.

- ▶ Select  ▶▶ **Detour** on the map.

Select one of the following options:

- **Detour by Distance:** Avoids a route for a certain distance.
- **Route detoured.:** Avoids a particular road on the route.
- **Detour:** Calculates a completely new route.

Editing a route with intermediate destinations

Requirements

- A route has already been started (→ page 158).

You can add intermediate destinations in the middle or at the end of your route.

- ▶ Select  on the map.
- ▶ Search for a position.
- ▶ Select a position.
- ▶ Press on **Go!**.

Select one of the following options:

- **Add as Next Stop:** Sets the location as the next intermediate destination on the route.
- **Add as Last Stop:** Adds the location at the end of the route.
- **Add to Active Route:** Adds the location and manages the order of destinations on the route.

The navigation system adds this position to the route. The route is recalculated with the individual destinations in the desired order.

Planning routes with myTrips

With the "myTrips" function you can set and save a route. This can be useful for the planning of a delivery route, a holiday or a journey. You can manage a saved route, e.g. to rearrange positions, optimize the order of the stops or add positions.

A route can include many destinations but must have at least one start location and one destination. The start location is the place from where you wish to set off on your journey. If you start navigation for the trip from another location, the multimedia system offers the option of driving to this location first. For a round-trip, the start and destination location can be the same.

Setting a route

- ▶ Select  ▶▶ **myTrips** ▶▶ **Create Trip** on the map.
- ▶ Select **Add Starting Point**.

- ▶ Select a position for the starting point.
- ▶ Select **Add Destinations**.
- ▶ Set a position for the destination and select with **Select**.
- ▶ If required, add more destinations for other positions and then select .
- ▶ Select **Trip Settings** ▶▶ **Trip Name**.
- ▶ Enter the name of the route and select **Done**.

Managing and rearranging positions on a route

- ▶ Select  ▶▶ **myTrips** on the map.
- ▶ Select a saved route.
- ▶ Select **Edit Destinations**.
- ▶ Select one of the following options:
Using the grip next to it, drag the destination to a new position on the route.

or

- ▶ Select an additional location with **Add Destinations**.

Deleting routes

- ▶ Select  ▶▶ **myTrips** ▶▶ **Delete Trips** on the map.
- ▶ Select one or more routes.
- ▶ Select **Delete**.

Showing traffic information

Real-time traffic data is an optional feature for your vehicle. Contact your vehicle dealer for more information on traffic functions. Traffic information is not available in all areas.

- ⓘ Daimler AG and Garmin are not responsible for the accuracy and timeliness of traffic information.

Displaying traffic ahead

- ▶ Select  ▶▶ **Traffic**.

Displaying the traffic map

- ▶ Select  ▶▶ **Traffic** ▶▶ **Traffic Map**.

Displaying the traffic legends

- ▶ Select  ▶▶ **Traffic** ▶▶ **Traffic Map** ▶▶  ▶▶ **Traffic Legend**.

Map and compass

Using the map





You can use the map for the following:

- Navigating along a route
- If no route is activated, displaying the map of the area

▶ Press on .

▶ Tap on any point on the map.

The following options are available:

- Move the map to the left, right, up or down.
- To enlarge or reduce the view, select  or .
- To switch between 2D and 3D view, select **2D** or **3D**.
- To rotate the map, select .
- To filter the POIs shown according to category, select  ▶▶ **Places along the road**.
- To start a route, select a location on the map and then press **Go!**.

Adjusting the map

Adjusting the map layers

You can customize which data is displayed on the map, e.g. symbols for POIs and road conditions.

▶ Select  ▶▶ **Settings** ▶▶ **Navigation** ▶▶ **Map and Vehicle** ▶▶ **Map Layer**.

▶ Tap on the checkboxes of the layers that are to be displayed on the map.

Changing the map data fields

- ▶ Select a data field on the map.
- ▶ Select a data type to be displayed.

Changing the map perspective

▶ Select  ▶▶ **Settings** ▶▶ **Navigation** ▶▶ **Map and Vehicle** ▶▶ **Driving Map View**.

▶ Tap on the checkboxes of the layers that are to be displayed on the map.

The following options are available:

- **Track Up:** The map is displayed in two dimensions with the direction of travel at the top.
- **North Up:** The map is displayed in two dimensions, with North at the top.
- **3D:** The map is displayed three-dimensionally.
- **Split Screen:** The map window is displayed alongside other applications.

Setting functions for smartphones

⚠ WARNING Risk of distraction from operating integrated communication equipment while the vehicle is in motion

If you operate communication equipment integrated in the vehicle when driving, you could be distracted from the traffic situation. This could also cause you to lose control of the vehicle.

- ▶ Only operate this equipment when the traffic situation permits.
- ▶ If you cannot be sure of this, stop the vehicle whilst paying attention to road and traffic conditions and operate the equipment with the vehicle stationary.

Observe also the legal requirements for the country in which you are driving.

Requirements

Bluetooth® mode via the multimedia system is available in conjunction with a Bluetooth®-capable smartphone.

- The smartphone is in the vehicle close to the multimedia system.
- The Bluetooth® function of the multimedia system is switched on.

Pairing smartphones

▶ Press on .

▶ Select **Connect Phone** ▶▶ **Add a device**.

▶ Activate Bluetooth® on your smartphone and make your smartphone visible for other devices.

i You can find additional information in the instruction manual for your smartphone.

▶ Select the name for your smartphone on the multimedia system.

▶ Follow the instructions on the media display to complete the pairing procedure.

Canceling smartphone pairing

▶ Press on .



▶ Select  next to the paired smartphone.

▶ Select **Forget This Device**.



Placing a call

▶ Press on .

The following options are available:

- Enter the telephone number using the keypad  and press on .
- To select a contact from the phone book: press  and select the contact.

The following options are available during a call:

- To transfer the sound output back to your smartphone, press on .
- ① You can use this function if you disconnect Bluetooth® and at the same time wish to maintain the call or conduct a private conversation.
- Call up the dial pad.
- ① You can use this function to use automated systems such as voicemail.
- Press on  to mute the microphone.
- Press on  to end a call.

Saving a telephone number as a preset

You can save up to four contacts as presets on dial pad. You can then quickly call frequently called contacts.

- ▶ Press on .
- ▶ Select **Add Preset Contact** and select a contact.

Displaying messages

- ▶ Select .
- ▶ Select a message.

Connecting Android Auto

- ▶ Make sure that the software on your Android™ smartphone is up to date
- ▶ Download and install the Android Auto app on the smartphone.
- ▶ Connect the Android™ smartphone with the USB media port in the vehicle using a suitable cable.
- ▶ Follow the instructions on the media display to complete the set-up procedure.

Connecting Apple CarPlay®

- ▶ Make sure that the software on the Apple iPhone® is up-to-date.
- ▶ Connect the Apple iPhone® with the USB media port in the vehicle using a genuine Apple® cable.
- ▶ Follow the instructions on the media display to complete the set-up procedure.

Android Auto and Apple CarPlay® can be activated by connecting a suitable mobile phone to USB port 1

Media

Information about supported formats and data storage media

⚠ WARNING Risk of distraction when handling data storage media

If you handle a data storage medium while driving, your attention is diverted from the traffic conditions. This could also cause you to lose control of the vehicle.

▶ Only handle a data storage medium when the vehicle is stationary.

The multimedia system is compatible with many media players, including smartphones and other portable devices. You can connect a compatible media player using Bluetooth® or USB.

The multimedia system is compatible with Android devices that support MTP mode.

If you connect an external hard drive, you have to connect this with an external power source. The USB port on the multimedia system cannot supply power to an external hard drive.

The multimedia system supports the following formats and data media:

Permissible file systems	FAT16, FAT32, NTFS
Permissible data carriers	USB devices, iPod®/iPhone®, MTP devices, Bluetooth® audio equipment
Supported formats:	MP3, WMA, AAC, WAV, FLAC

① Observe the following notes:

- Due to the wide range of USB devices available on the market, playback cannot be guaranteed for all USB devices.
- Copy-protected music files or DRM (Digital Rights Management) encrypted files cannot be played back.
- MP3 players must support Media Transfer Protocol (MTP).

Overview of the media menu

The information displayed on the media display and visible playback controls may change depending on the media source.

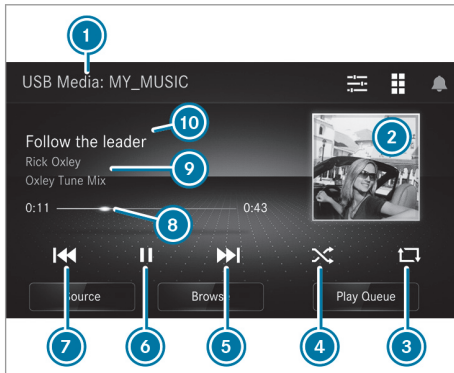

Example: Track is played from a USB device

- ① Active media source
- ② Album cover, if available from a compatible source
- ③ Repeat (once per track)
- ④ Random playback (shuffle mode)
- ⑤ Next track
- ⑥ Controls playback (pause)
- ⑦ Previous track
- ⑧ Timeline (elapsed playing time and playing time of the track)
- ⑨ Details about the track (if available)
- ⑩ Track

Connecting USB devices

NOTE Damage caused by high temperatures

High temperatures can damage USB devices.

▶ Remove the USB device after use and take it out of the vehicle.

- ▶ Connect the USB device to the USB port.
- ▶ Press on .
- ▶ Select **Source** ▶▶ **USB**.

ⓘ When connecting several Apple® devices, pay attention to the order in which the devices are connected. The multimedia system only connects with the device that is connected first. Additional Apple® devices that are con-

nected at the same time are only supplied with power.

Starting media playback

Requirements

A data storage medium is connected to the multimedia system.

- ▶ Press .
- ▶ Select a media source with **Source**.
- ▶ Select the desired track or station.

Adjusting the volume

- ▶ Press on .
- ▶ Select .
- ▶ Press on or until the desired volume is set.

Information on playback using Bluetooth® devices

When using Bluetooth® devices you can control playback with the control elements on the multimedia system. With some devices you can also search the music library from the menu. On Bluetooth® devices that do not support this type of search, select the track or the playlist directly on the media player itself.

Whether track information such as the song title, artist name, track length and album cover are available, depends on the functions of the media player and the music app.

Radio

Selecting a radio station

- ▶ Select the respective source, e.g. **FM Radio**.

One of the following options is available:

- To set a lower or higher radio frequency: select or .
- To search for available radio stations: select **Scan**.
- To view a list of the available radio stations: select **Station List**.

Setting DAB stations



DAB stations are not available in all regions.

Station scan for DAB stations

- ▶ Select **DAB Radio**.
 - ▶ Press on **Scan**.
- When the search is complete, the first available station in the first ensemble found is played.

i After the first search, you can select **Scan** again to search for DAB stations again. When the new search is finished the multimedia system plays back the first station in the ensemble which you were listening to at the beginning of the new search.

Changing DAB stations

- ▶ Select **DAB Radio**.
 - ▶ If required, select **Scan** to search for a local DAB station.
 - ▶ Select  or  to change the DAB station.
- At the end of the current ensemble the multimedia system automatically changes to the first available station in the next ensemble.

Selecting a DAB station from a list

- ▶ Select **DAB Radio**.
- ▶ If required, select **Scan** to search for a local DAB station.
- ▶ Select **Station List**.
- ▶ If required, select a category.
- ▶ Select a station.

Saving a station as a favorite

- ▶ Select the respective source, e.g. **FM Radio**.
- ▶ Select **Favourites**.

The following options are available:

- To store a station in an available preset: select preset.
- To replace a station that has been saved: press and hold on the preset and select **Replace**.

Switching the traffic information service on or off

The traffic information service uses the radio data system (RDS), to provide you with current traffic information. If the system receives a traffic announcement it switches automatically to the station transmitting the traffic announcement. When the announcement is finished the system returns to the previous station.

- ▶ **To switch on the traffic information service:** select .
- ▶ Select **RDS Announcements - TA**.

Satellite radio

Information on the satellite radio

SIRIUS XM[®] satellite radio offers more than 140 digital-quality radio channels providing 100% commercial-free music, sports, news and entertainment, for example. SIRIUS XM[®] satellite radio employs a fleet of high-performance satellites to broadcast around the clock throughout the USA and Canada. The satellite radio program is available for a monthly fee. Information about this can be obtained from a SiriusXM[®] Service Center and at <https://www.siriusxm.com> (USA) or <https://www.siriusxm.ca> (Canada).

i Sirius, XM and all related marks and logos are trademarks of SiriusXM Radio Inc. and its subsidiaries. All other marks, channel names and logos are the property of their respective owners. All rights reserved.

Registering satellite radio

Requirements

- Satellite radio equipment
- The registration with a satellite radio provider

i If registration is not included when purchasing the system, your credit card details will be required to activate your account

Before you are able to activate your SiriusXM[®] subscription you will need to have the radio ID for your SiriusXM Connect Tuner available. You can call up this radio ID in the SiriusXM[®] settings menu or set your stereo system to channel 0.

- ▶ Select  **▶▶ SiriusXM Settings ▶▶ SiriusXM Radio ID**.

The service information screen appears showing the radio ID and the current subscription status.

- ▶ Establish a telephone connection.
- ▶ Follow the service staff's instructions. The activation process may take up to ten minutes.

i You can also have the satellite service activated online. To do so, please visit <https://www.siriusxm.com> (USA) or <https://www.siriusxm.ca> (Canada).

Selecting a satellite radio category

You can make a station selection based on categories.





- ▶ Select SiriusXM® as the media source.
- ▶ Select **Browse** ▶▶ **POIs**.
- ▶ Select a category.

Using playback mode

Playback mode is used to control playback of a SiriusXM® broadcast.

- ❶ The device automatically activates the playback mode when stored preset channels are played back.
- ▶ If necessary, select **Live** to switch to playback mode.

The following options are available:

- To continue or pause playback: select  or .
- To stop playback mode: select **Replay**.
- To fast forward or rewind step by step: select  or .

- ❶ If you fast forward or rewind to the end of the progress bar, playback mode is automatically exited and switched to the current real-time transmission.

Creating a TuneMix™ list

Before you can playback a TuneMix™ list, you must have saved two or more channel presets.

The TuneMix™ function allows you to put together an individual listening experience with your favorite music channels.

- ▶ Set SiriusXM® as the media source and select **Favourites**.
- ▶ Select **TuneMix**.
- ▶ **To end playback:** select **Favourites** ▶▶ **TuneMix**.

Switching the TuneStart™ function on or off

When you activate the TuneStart™ function and switch to a preset channel, the track currently playing is played back from the beginning. It does not start at the point at which the live transmission is currently broadcasting.

- ❶ The TuneStart™ function is only available when you switch on preset channels.
- ▶ Select .
- ▶ Select **SiriusXM Settings** ▶▶ **Tune Start**.
- ❶ When the TuneStart™ function plays a track from the beginning, a progress bar is shown

with which you can control the playback of the track and the playback mode.

Searching unsubscribed channels

You can activate unsubscribed channels.

- ▶ Select SiriusXM® as the media source.
- ▶ Select **SiriusXM Settings** ▶▶ **Unsubscribe Channel List**.
Unsubscribed channels in the channel list are displayed with gray text.

You cannot set an unsubscribed channel by tapping it. You can display the following information, for example: the channel name, the name of the currently playing artist and track.

Deleting user data

All SiriusXM® user information, e.g. presets and other data, can be deleted.

- ▶ Select .
- ▶ Select **SiriusXM Settings** ▶▶ **SiriusXM User Data Reset**.

Updating maps and system software



When you download the latest software update, you get new map material, updated features and performance improvements.

Map updates have the following advantages:

- Your multimedia system takes into account all current changes in the course of the road.
- The maps are kept up to date, for example to find recently added points of interest.

Map updates are extensive and may take several hours.

Software updates provide innovations and improvements in the features and functionality of the multimedia system. Software updates are small and take only a few minutes.

- ▶ **To update system software:** press on .
- ▶ Select **Settings** ▶▶ **About** ▶▶ **System Update**.
- ▶ Follow the instructions on the media display.
- ▶ **To update maps:** press on .
- ▶ Select **Settings** ▶▶ **Navigation** ▶▶ **Map and Vehicle** ▶▶ **Map Updates**.
- ▶ Follow the instructions on the media display.
- ▶ For more information on updating maps and software for the multimedia system <https://auto-oem.garmin.com/landing/site>.

Notes on loading guidelines

⚠ DANGER Risk of poisoning from exhaust gases

Combustion engines emit poisonous exhaust gases, such as carbon monoxide. Exhaust gases can enter the vehicle interior if the tailgate or the rear-end door is open when the engine is running, especially if the vehicle is in motion.

- ▶ Always switch off the engine before opening the tailgate or the rear-end door.
- ▶ Never drive the vehicle when the tailgate or rear-end door is open.

⚠ WARNING Risk of injury from unsecured objects in the vehicle

When objects are unsecured or inadequately secured, they can slip, tip over or be thrown about, striking vehicle occupants.

This also applies to:

- Luggage or loads
- Seats which have been removed and are being transported in the vehicle in an exceptional case

There is a risk of injury, particularly in the event of braking maneuvers or abrupt changes in direction.

- ▶ Always stow objects in such a way that they cannot be tossed about.
- ▶ Before traveling, secure objects, luggage or load to prevent them slipping or tipping over.
- ▶ When a seat is removed, keep it preferably outside the vehicle.

⚠ WARNING Risk of accident due to incorrectly positioned load

The center of gravity of the load can be too high and/or too far towards the rear.

This can significantly impair handling as well as steering and braking characteristics.

- ▶ Always make sure that the center of gravity of the load is between the axles and as low as possible near the rear axle.

⚠ WARNING Risk of accident due to exceeding the permissible wheel/axle loads or the gross vehicle weight

The driving characteristics, as well as steering and braking, may be greatly impaired. Overloaded tires may overheat and burst as a consequence.

- ▶ When transporting a load, always observe the permissible wheel loads, axle loads and the maximum permissible gross mass for the vehicle (including occupants).

⚠ WARNING Risk of injury if unsuitable climbing aids are used

If you use openings in the vehicle's body work or detachable parts as steps, you could:

- Slip and/or fall.
- Damage the vehicle and thus slip and fall.

- ▶ Always use anti-slip, stable climbing aids, e.g. a suitable ladder.

! NOTE Damage caused by the use of openings in the bodywork or detachable part as a step

Using the lower guide of the sliding door (carriage) as a step can damage the trim and/or mechanism of the sliding door.

- ▶ Do not use the guide of the sliding door (carriage) as a step.

If you are using a roof luggage rack, please note the maximum roof load and the maximum load capacity of the roof luggage rack (→ page 234).

The handling characteristics of your vehicle are dependent on the load distribution.

Therefore, please observe the following notes when loading:

- The load must not protrude above the upper edge of the seat backrests.
- If possible, always transport the load in the cargo compartment.
- fasten the load to the tie-down eyes and distribute the load evenly among them.

- If available, use a load protection net to secure the load (→ page 172).
- Use tie-down eyes and fastening components which are suitable for the weight and size of the load.

When using load securing aids and tie-downs, follow the manufacturer's operating instructions and the instructions for disposal.

Load securing aids and tie-downs are ready for disposal, unusable and must be replaced in the following cases:

- There is missing or illegible identification
- There is cord breakage or damage to load-bearing seams or other traces of cracking
- There are cuts, holes, deformations, crushed areas or other damage
- There is damage to clamping elements or fasteners

If the trunk floor or loading area are damaged in the event of an accident, have the tie-down eyes and the tie downs checked at a specialist workshop.

Even if you adhere to all the loading guidelines, an increased load increases the risk of injury in the event of an accident.

Before loading

! **NOTE** Damage to the vehicle and the load due to anti-slip mats which are no longer suitable

If you use anti-slip mats that display the following characteristics, they must be replaced:

- Permanent deformation and crushed areas
- Traces of cracking
- Cuts or holes

Please observe the following before loading the vehicle:

- Clean the cargo compartment floor, if necessary.
The cargo compartment floor must be free from oil and dust, dry and swept clean to prevent the load from slipping.
- Lay anti-slip mats on the cargo compartment floor.
- Check and, when necessary, adjust the tire pressure (→ page 206).

When loading

Observe the following when loading the vehicle:

- Never exceed the gross axle weight rating or the vehicle's permissible gross mass.
The vehicle's curb weight is increased if accessories or optional equipment are installed. This reduces the maximum payload.
- Observe the notes on load distribution (→ page 167).
- Observe the notes on load securing (→ page 168) and the legal requirements of the country in which you are currently driving.
- Observe the safety information on the carrier systems (→ page 173).

After loading

Observe the following after loading the vehicle:

- Check that the luggage and/or load is secure before every journey and at regular intervals on long trips.
- Close all doors and the tailgate.
- Adjust the range of the headlamps according to the vehicle load (→ page 78).
- Adjust the tire pressure according to the vehicle load (→ page 206).
- Adapt your driving style according to the vehicle load.

Load distribution

! **NOTE** Damage to the floor covering due to uneven loading

Excessive point loading on the cargo compartment floor or on the load area can negatively affect the driving characteristics and could damage the floor covering.

- ▶ Distribute the load evenly. When doing so, ensure that the overall center of gravity of the load is always as low and close to the center as possible and between the axles near the rear axle.

Observe the following notes:

- Always transport loads in the cargo compartment and with the seat backrests folded up and properly locked in position.
- Always place the load against the front or rear seat backrests.

- Move large and heavy loads as far as possible towards the front of the vehicle in the direction of travel, against the front or rear seats. Store loads flush with the rear or front seats.
- Additionally secure the load with suitable load securing aids or tie downs.
- The load must not protrude above the upper edge of the seat backrests.
- Transport loads behind seats that are not occupied.
- If the rear bench seat is not occupied, insert the seat belts crosswise into the seat belt buckle of the opposite seat belt.

Cargo compartment variants

You can vary the cargo compartment according to your transportation requirements as follows:

- By folding the seat backrests forward to the table position
- By removing the rear bench seat

You will find information about rear bench seats in the "Seats" section (→ page 66).

Securing loads

Notes on load securing

⚠ WARNING Risk of accident and injury due to incorrect use of the lashing straps

The following can occur:

- The tie-down eyes may detach or the lashing strap may tear if the permissible load is exceeded
- The load cannot be restrained

The load can slip, tip over or be flung about, striking vehicle occupants.

- ▶ Always tension the lashing straps in the proper manner and only between the described tie-down eyes.
- ▶ Always use lashing straps designed specifically for the loads.

! NOTE Damage to the vehicle if the maximum loading capacity of the cargo tie-down point is exceeded

If you combine various cargo tie-down points to secure a load, always take the maximum

loading capacity of the weakest cargo tie-down point into account.

During maximum full-stop braking, forces may act which can multiply the weight of the load.

- ▶ Always use several cargo tie-down points to distribute the load.
- ▶ Distribute the load on the cargo tie-down points evenly.

Observe the Operating Instructions or the lashing strap manufacturer's instructions for the operation of the lashing strap.

Observe the information relating to the maximum loading capacity of the cargo tie-down points (→ page 234).

As the driver, you are responsible for ensuring the following:

- The load is secured against slipping, tipping, rolling or falling off.

Take usual traffic conditions as well as swerving or full brake application and bad roads into account.

- The applicable requirements and guidelines relating to load-securing practices are met.

If this is not the case, this may constitute a punishable offense, depending on local legislation and any ensuing consequences.

Observe country-specific laws.

Make sure that the load is secure before every journey and at regular intervals during a long journey. Adjust the load securing as necessary. Information on how to secure loads correctly can be obtained from the manufacturers of the load securing aids or tie downs for load securing, for example.

Also observe the notes on loading guidelines (→ page 166).

When securing loads, observe the following:

- Fill spaces between the load and the cargo compartment walls or wheel wells. For this purpose, use rigid load securing aids, such as chocks, wooden fixings or padding.
- Attach secured and stabilized loads in all directions.

Use the cargo tie-down points or the tie-down eyes and guide rails in the rear compartment.

Only use tie downs, such as lashing nets and lashing straps, which have been tested in accordance with current standards. Always

use the cargo tie-down points closest to the load; pad sharp edges.

Note on the cargo tie-down points and tie-down eyes on the cargo compartment floor for touring motorcycles (vehicle category M1)

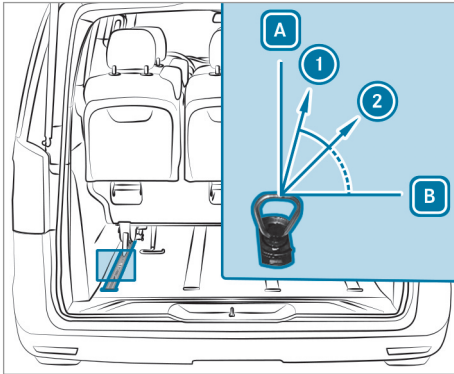

Example: lashing angle for optimal load security

- A** Vertical to the cargo compartment floor
- B** Cargo compartment floor
- 1** Direction of pull with 75° lashing angle
- 2** Direction of pull with 45° lashing angle

The lashing angle is the angle formed between the cargo compartment floor and the tie down. For optimum load securing in accordance with standard ISO 27955 the lashing angle must be between 45° **2** and 75° **1**. The maximum nominal tensile load of 786.5 lbf (350 daN) for the tie-down eyes in the cargo compartment floor or in the guide rails may not be exceeded.

Notes on the partition for commercial vehicles (vehicle category N1)

Without a partition, vehicles approved as commercial vehicles (vehicle category N1) do not fulfill the currently valid version of standard ISO 27956. Standard ISO 27956 describes the equipment for properly securing a load in delivery vehicles. If the vehicle is used to transport goods, retrofitting the partition is strongly recommended, as properly securing the load in vehicles without a partition will always be a complex operation.

Overview of cargo tie-down points

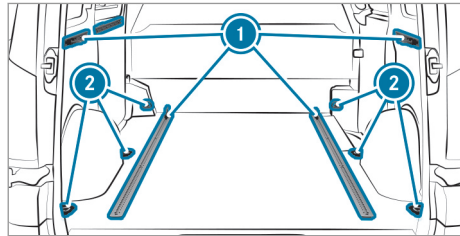

Cargo tie-down points (example: Cargo Van)

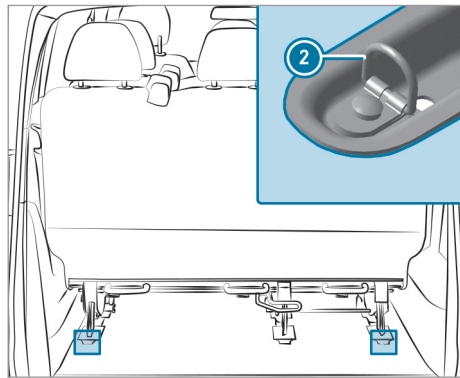

Fixed cargo tie-down points on the floor (example: Tourer with seat anchorages)

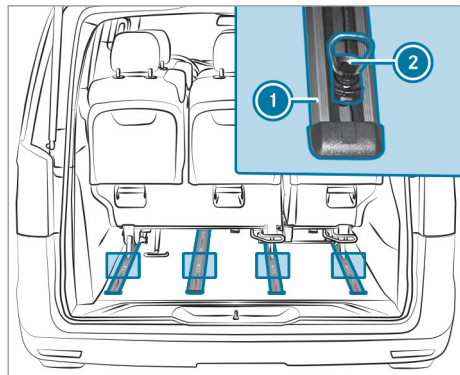

Example: variable cargo tie-down points in the guide rails

- 1** Guide/loading rails
- 2** Tie-down eye

If your vehicle is equipped with guide or loading rails **1** in the cargo compartment floor, you can place lashing rods directly in front of and behind

the load. The lashing rods directly absorb the potential shifting forces.

Securing loads on the cargo compartment floor by lashing them down is only recommended for lightweight loads. Lay anti-slip mats under the load to assist in securing it.

Do not attempt to modify or repair the cargo tie-down points, tie-down eyes or tie downs. Read the information on qualified specialist workshops (→ page 18).

Using lashing straps

Observe the operating instructions or the lashing strap manufacturer's instructions for the operation of the lashing strap.

Securing loads on the cargo compartment floor by lashing them down is only recommended for lightweight loads. Lay anti-slip mats under the load to assist in securing it.

- ▶ Observe the notes on securing loads (→ page 168).
- ▶ Observe the maximum loading capacity of the cargo tie-down points and tie-down eyes (→ page 234).

Notes and information on the maximum loading capacity of the lashing strap can be found on the lashing strap label. If the label is missing or illegible, the lashing strap is ready to be discarded and must be replaced. Such a lashing strap must not be used.

If reference stickers were included on delivery, affix them to the vehicle as follows:

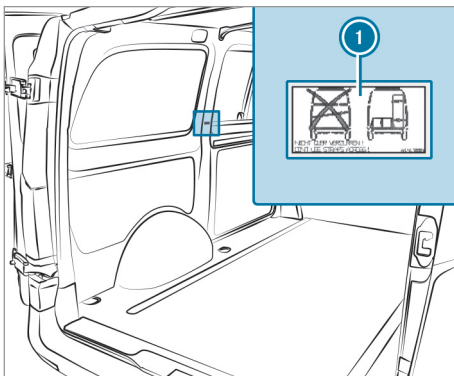

- ▶ Clean the surface before sticker ① is affixed. The stickers must be affixed to a flat, metallic surface free from grease and dust.

- ▶ Affix stickers ① on every side of the vehicle in close proximity to the loading rails in a clearly visible location.

Tensioning strap

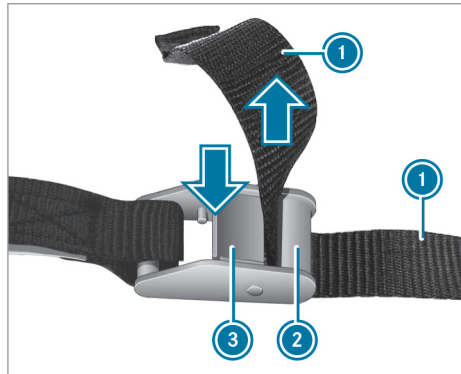

- ▶ Observe the Operating Instructions or the manufacturer's notes on how to use the tensioning strap.

Tightening

- ▶ Press and hold tensioning lever ③.
- ▶ Guide tensioning strap ① between tensioning lever ③ and brace ② as illustrated and tighten.
- ▶ Release tensioning lever ③.

Releasing

- ▶ Press and hold tensioning lever ③.
- ▶ Pull tensioning strap ① out of the strap buckle.

Ratchet strap

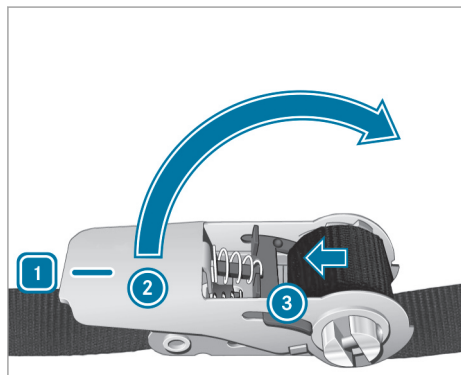

- ▶ Observe the Operating Instructions or the manufacturer's notes on how to use the ratchet strap.

Releasing the tensioning lever

- ▶ Press slider lock ③ outwards in the direction of the arrow and swing tensioning lever ② from detent position ① to the desired position.

Tightening the ratchet strap

- ▶ Release and open tensioning lever ②.

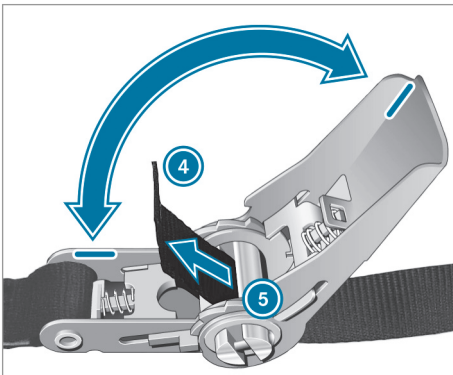

Threading and tensioning

- ▶ Guide ratchet strap ④ through slotted shaft ⑤ from behind as illustrated and tighten it.
- ▶ Swing tensioning lever ② back and forth until ratchet strap ④ has wound around slotted shaft ⑤ and is sufficiently tensioned.
- ▶ Swing tensioning lever ② to detent position ①.

Releasing the ratchet strap

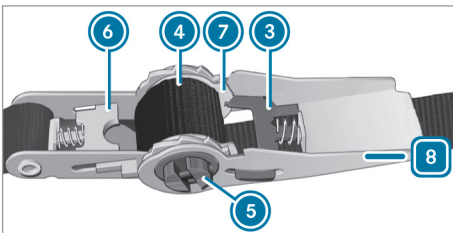

Tensioning lever in the release position

- ▶ Press and hold slider lock ③ outwards.

- ▶ Swing tensioning lever ② as far as it will go to release position ⑧ and release slider lock ③. Slider lock ③ engages in end recess ⑦ and slider lock ⑥ unlocks slotted shaft ⑤.
- ▶ Pull ratchet strap ④ out of the ratchet.

Installing and removing tie-down eyes

▲ WARNING Risk of injury due to incorrectly installed tie-down eyes

If the tie-down eyes are not correctly installed, they can slip or tear out.

This may cause objects, luggage or the load to slip, tip over or be thrown about the vehicle interior, striking vehicle occupants.

- ▶ Make sure that the tie-down eyes are correctly installed and do not move.

- ▶ Observe the notes on loading guidelines and on securing loads (→ page 166).

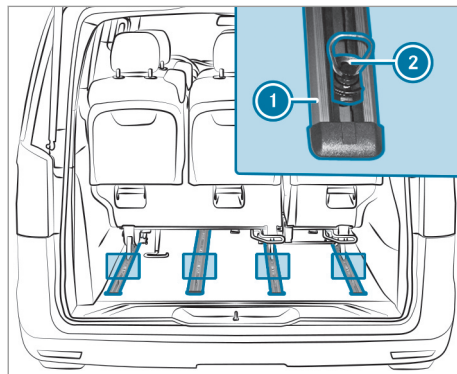

Example: guide rails

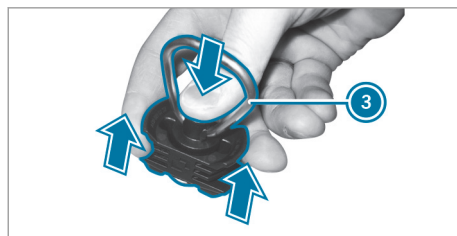

Tie-down eyes for guide rails

Installing

- ▶ Turn metal retaining ring ③ so that it is parallel to the long axis of tie-down eye ② as illustrated.
The locking pin can only be pushed down sufficiently and allow the tie-down eye to be installed, moved or removed, if the metal retaining ring is parallel to the long axis of the tie-down eye.
- ▶ Hold tie-down eye ② between your forefinger and middle finger as illustrated, and place your thumb through metal retaining ring ③ and on the central pressure point.
- ▶ Use your thumb to push the locking pin down as far as it will go.
- ▶ Push tie-down eye ② near the load using the notches on guide rail ①, and move it approximately 0.5 in (12 mm).
- ▶ Remove your thumb from the pressure point and slide tie-down eye ② until it engages.
- ▶ Turn metal retaining ring ③ so that it is perpendicular to the long axis of tie-down eye ②.
The locking pin cannot be pushed down far if the metal retaining ring is perpendicular to the long axis of the tie-down eye. This prevents the tie-down eye from being released unintentionally, e.g. if the tie-down eye is stepped on.
- ▶ Check that tie-down eye ② is seated correctly.
The tie-down eye cannot be moved.

Removing

- ▶ Turn metal retaining ring ③ so that it is parallel to the long axis of tie-down eye ②.
- ▶ Grip tie-down eye ② as described above under installing and use your thumb to push the locking pin down as far as it will go.
- ▶ Slide tie-down eye ② and pull it up and out through the notch of guide rail ①.

Load securing aid

Removing/installing a load protection net

- ⚠ **WARNING** Risk of injury or death due to objects being poorly secured

The load protection net alone cannot restrain or secure heavy objects, luggage or heavy loads.

You could be hit by an unsecured load during sudden changes in direction, braking or in the event of an accident.

- ▶ Always stow objects in such a way that they cannot be thrown about the vehicle.
- ▶ Secure objects, luggage or loads against slipping or tipping over, e.g. by using tie downs, even when you are using the load protection net.

- ⚠ **WARNING** Risk of injury due to sitting behind a partitioning net

Vehicle occupants can be pressed against the partitioning net. There is a risk of injury.

- ▶ Never allow vehicle occupants to sit behind the partitioning net.

The load protection net partitions the cargo compartment. It protects vehicle occupants from light objects and/or luggage slipping or tipping over.

You can install the load protection net at an angle behind the front seats or behind the first row of rear seats.

- ▶ Observe the notes on securing loads (→ page 168).

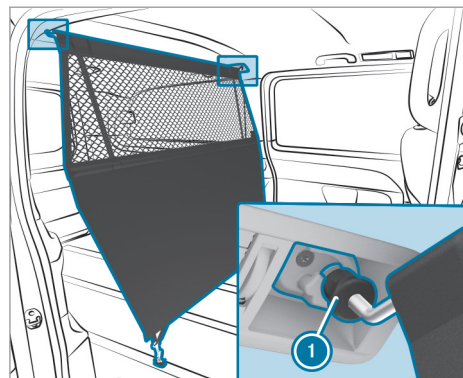

Upper retainer

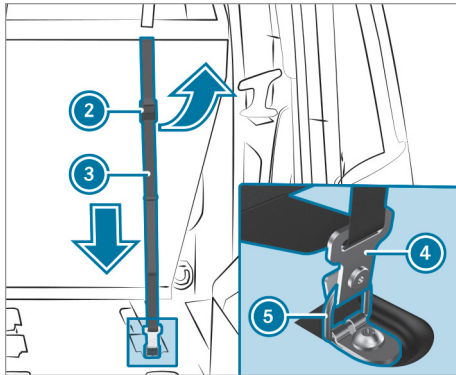

Floor anchorage (example: secured tie-down eye)

Installing

- ▶ Remove the cargo compartment partition if necessary .
- ▶ Clip the load protection net into upper retainers ① in such a way that tensioning straps ③ face the rear of the vehicle.
- ▶ Install tie-down eyes ⑤ into the guide rails close to the rear seat legs (→ page 171). Position them at least 2 in (5 cm) from the seat legs to allow subsequent movement of the rear seat.
- ▶ Check that tie-down eyes ⑤ are seated correctly. Tie-down eyes ⑤ should not move.
- ▶ Pull tensioning straps ③ of the load protection net tightly.
- ▶ Clip hooks ④ on tensioning straps ③ into tie-down eyes ⑤ .
- ▶ Fold tensioning element ② up.
- ▶ Pull the loose end of tensioning straps ③ down in the direction of the arrow until tensioning straps ③ are tight.
- ▶ Fold tensioning element ② down to achieve the final tension on the straps.
- ▶ If necessary, install the cargo compartment partition .
- ▶ After traveling a short distance, check that the load protection net is taut, and retighten it if necessary.

Removing

- ▶ Remove the cargo compartment partition if necessary .

- ▶ Fold tensioning element ② up. Tensioning straps ③ are slack.
- ▶ Unclip hooks ④ of tensioning straps ③ from tie-down eyes ⑤ at the bottom.
- ▶ Unclip the load protection net from upper retainers ① .
- ▶ When required, remove tie-down eyes ⑤ (→ page 171).
- ▶ If necessary, install the cargo compartment partition .
- ▶ Roll up the load protection net and fasten it, still rolled up, using the Velcro fasteners.

Adjusting the front seat with the load protection net installed

- ▶ Fold tensioning element ② on straps ③ upwards. The load protection net slackens.
- ▶ Correctly adjust the front seat.
- ▶ Re-tension the load protection net.

Carrier systems

Notes on carrier systems

⚠ WARNING Risk of accident due to exceeding the maximum roof load

The vehicle center of gravity and the usual driving characteristics as well as the steering and braking characteristics alter.

If you exceed the maximum roof load, the driving characteristics, as well as steering and braking, will be greatly impaired.

- ▶ Never exceed the maximum roof load and adjust your driving style.

You can find information on the maximum roof load under "Cargo tie-down points and carrier systems" (→ page 234).

⚠ NOTE Damage due to exceeding the maximum permissible roof load

If the weight of the roof luggage, including the roof luggage rack, exceeds the maximum permissible roof load, this can cause damage to the vehicle.

- ▶ Do not exceed the maximum permissible roof load.

- ▶ Arrange the supporting feet of the roof luggage rack at an even distance from each other.
- ▶ Install the basic carrier bars for rail in front of and behind the mid-section support.

I **NOTE** Damage to the threaded holes of the roof luggage rack due to an excessively high tightening torque

An excessively high tightening torque or an insufficient screw-in depth can cause damage to the thread of the roof luggage rack's threaded holes.

- ▶ Tighten the screws to a maximum torque of 7.4 lb-ft (10 Nm).
- ▶ Comply with the minimum screw penetration of four revolutions in the thread.

Use roof and rear luggage racks that have been approved or recommended for Mercedes-Benz. These help to prevent vehicle damage.

You can install a roof luggage rack on the roof and, for example, a rear bicycle rack on the tailgate.

Install the cover caps of the securing thread after removing the roof luggage rack.

If you have installed a rear luggage rack on the tailgate, the additional weight restricts the assistance offered by the pneumatic springs when you open the tailgate. You will then need more force to open the tailgate. At low outside temperatures below freezing point, you should provide additional support for the tailgate after opening it in order to prevent it from lowering unintentionally.

Notes on maintenance



ENVIRONMENTAL NOTE Environmental pollution due to disposal in a non-environmentally-friendly manner

If circumstances demand that you have to do some maintenance work yourself, environmental protection requirements must be observed. When disposing of service products, e.g. engine oil, you must comply with the legal requirements. This also includes all components, e.g. filters, which have come into contact with operating fluids.

- ▶ Dispose of empty containers, cleaning cloths and care products in an environmentally responsible manner.
- ▶ Observe the instructions for care products.
- ▶ Do not run the engine for longer than necessary when the vehicle is stationary.

When working on the vehicle, comply with all safety regulations, such as the operating instructions, regulations concerning hazardous materials, environmental protection measures, work safety and accident prevention regulations.

You must secure the vehicle on jack stands of sufficient load-bearing capacity if work is being carried out underneath the vehicle.

Please also refer to the notes about qualified specialist workshops (→ page 18).

The scope and regularity of the inspection and maintenance work primarily depend on the often diverse operating conditions. Inspection and maintenance work requires special skills that cannot be acquired by reading these Operating Instructions. This work should only be carried out by trained personnel.

The vehicle Maintenance Booklet describes the scope and frequency of maintenance work and contains additional notes on the Limited Warranty. You will find information about operating fluids approved for Mercedes-Benz and capacities under "Operating Fluids and Capacities" (→ page 227).

Maintenance services must be carried out in accordance with the instructions in the Maintenance Booklet. Not doing so could void any warranty claims and lead to refusal of goodwill gestures after the manufacturer has submitted a damage report.

Observe the information under "Mercedes-Benz GenuineParts" (→ page 13).

Service interval display

Service interval display function

The ASSYST PLUS service interval display on the instrument cluster display provides information on the remaining time or distance before the next service due date.

Under arduous operating conditions or if the vehicle is subjected to increased loads, the ASSYST PLUS service interval display may shorten the service interval.

You can obtain further information concerning the servicing of your vehicle from a qualified specialist workshop.

Displaying the service due date (vehicles without steering wheel buttons)

Requirements:

- The vehicle is stationary.
- The ignition is switched on.

Use the buttons on the instrument cluster.

- ▶ Press the button to select the service display. The display will show a possible service message.
- ▶ **To exit the display:** press the button on the instrument cluster.

Displaying the service due date (vehicles with steering wheel buttons)

Requirements:

- The ignition is switched on.

On-board computer:

Service ASSYST PLUS

The next service due date is displayed.

- ▶ **To exit the display:** press the or steering-wheel button.

Information on regular maintenance work

! **NOTE** Premature wear through failure to observe service due dates

Maintenance work which is not carried out at the right time or incompletely can lead to increased wear and damage to the vehicle.

- ▶ Adhere to the prescribed service intervals.
- ▶ Always have the prescribed maintenance work carried out at a qualified specialist workshop.

Notes on special service requirements

The prescribed service interval is based on normal vehicle use. Maintenance work will need to be performed more often than prescribed if the vehicle is operated under arduous operating conditions or increased loads.

Arduous operating conditions include:

- Regular city driving with frequent intermediate stops
- Frequent short-distance driving
- Frequent operation in mountainous terrain or on poor road surfaces
- When the engine is often left idling for long periods
- Operation in particularly dusty conditions and/or if air-recirculation mode is frequently used

In these or similar operating conditions, have the air filter, engine oil and oil filter, for example, replaced more frequently.

If the vehicle is subjected to increased loads, the tires must be checked more frequently. You can obtain further information at a qualified specialist workshop.

Non-operational times with the battery disconnected

The ASSYST PLUS service interval display can only calculate the service due date when the battery is connected.

- ▶ Display and note down the service due date on the instrument cluster before disconnecting the battery.

- Displaying the service due date in vehicles without steering wheel buttons (→ page 175).
- Displaying the service due date in vehicles with steering wheel buttons (→ page 175).

Engine compartment

Opening and closing the hood

! **WARNING** Risk of accident due to driving with the hood unlocked

The hood may open and block your view.

- ▶ Never release the hood when driving.
- ▶ Before every trip, ensure that the hood is locked.

! **WARNING** Risk of accident and injury when opening and closing the hood

The hood may suddenly drop into the end position.

There is a risk of injury for anyone in the hood's range of movement.

- ▶ Do not open or close the hood if there is a person in the hood's range of movement.

! **WARNING** Risk of injury from touching components under voltage

The ignition system and the fuel injection system work under high voltage. You could receive an electric shock.

- ▶ Never touch components of the ignition system or the fuel injection system when the ignition is switched on.

The following are examples of live components:

- Ignition coils
- Spark plug connectors
- Injectors

! **WARNING** Risk of burns from hot component parts in the engine compartment

Certain component parts in the engine compartment can be very hot, e.g. the engine, the cooler and parts of the exhaust system.

- ▶ Allow the engine to cool down and only touch component parts described in the following.

! **NOTE** Damage to hood or windshield wipers when opening the hood

If the windshield wipers have been folded back from the windshield when the hood is opened, the windshield wipers or the hood may be damaged.

- ▶ Ensure that the windshield wipers have not been folded back from the windshield.

Opening the hood

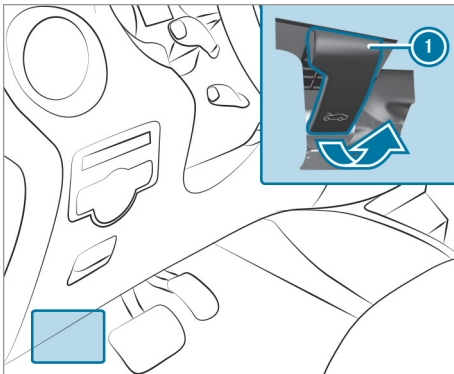

- ▶ Pull handle ① to release the hood.

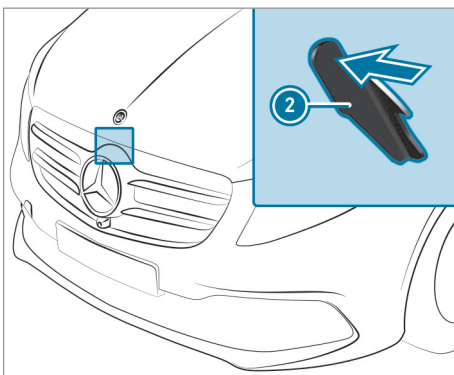

- ▶ Reach into the gap and push lever ② of the hood catch to the left.
- ▶ Lift the hood and hold it in place.

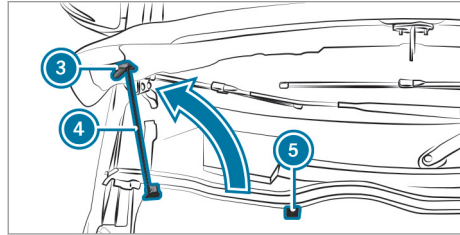

- ▶ Pull support strut ④ out of holder ⑤ and guide it upwards in the direction of the arrow.
- ▶ Lower the hood in such a way that support strut ④ slides into recess ③ and the hood is fixed in place.

Closing the hood

! **WARNING** Risk of fire due to flammable materials in the engine compartment or on the exhaust system

Flammable materials may ignite.

- ▶ Ensure that there are no flammable external materials in the engine compartment or on the exhaust system after maintenance work has been carried out.

! **NOTE** Damage to the hood due to pressing it closed manually

Pushing the hood closed with your hands could damage it.

- ▶ To close the hood, let it drop from the specified height.

- ▶ Hold support strut ④ and raise the hood slightly.
- ▶ Guide support strut ④ to holder ⑤ and apply gentle pressure to engage it.
- ▶ Lower the hood and let it fall from a height of approximately 12 in (30 cm), applying a little force as you let it go.
- ▶ If the hood can be lifted slightly more, open the hood once again and allow it to drop more forcefully so that it engages correctly.

Engine oil

Checking the engine oil level with the on-board computer (vehicle without steering-wheel buttons)



Requirements:

- The vehicle is equipped with an oil level sensor (vehicles with rear-wheel drive).
- The vehicle is level during the measuring process.
- The engine is switched off at normal operating temperature.
- A waiting period of five minutes is observed.
- The ignition is switched on.

If no oil level is displayed after five minutes at extremely low temperatures, repeat the engine oil measurement after another five minutes.

If an oil level reading is still not displayed, check the oil level with the oil dipstick (→ page 179). Have the engine oil level checked at a qualified specialist workshop.

Use the buttons on the instrument cluster.

- ▶ Press the  button to select **Oil Level**.
- ▶ Press the  button to confirm. While the engine oil level measurement is in progress, the display shows the **Measuring Engine Oil Level...** message.

The following messages may appear after the engine oil level measurement:

Engine Oil Level OK

- ▶ Do not refill oil.

Add 1,0 liq.gal. Engine Oil

- ▶ Add the specified quantity of oil (→ page 179).
- ▶ Repeat the engine oil measurement after a few minutes.

Engine Oil Level: Reduce Oil Level

- ▶ Siphon off any excess engine oil that has been added. To do so, consult a qualified specialist workshop.

For Eng. Oil Level: Ignition Must Be On

- ▶ Switch on the ignition.

Wait to Check Engine Oil Level

- ▶ If the engine is at normal operating temperature, repeat the engine oil measurement after approximately five minutes.
- ▶ If the engine is not at normal operating temperature, repeat the engine oil measurement after approximately 30 minutes.

Engine Oil Level with Engine Off

- ▶ Switch off the engine and, when it is at normal operating temperature, wait approximately five minutes before measuring the engine oil level.

Check the engine oil level with the on-board computer (vehicle with steering-wheel buttons)

Requirements:

- The engine oil level is determined during driving.
- The engine is at normal operating temperature.
- The vehicle is level during the measuring process.
- The hood is not open.

Depending on the driving profile, the oil level can be displayed only after a driving time of up to 30 minutes and only when the ignition is switched on.

On-board computer:

 **Service**  **Engine Oil Level**

One of the following messages appears on the display of the on-board computer:

Engine Oil Level Measurement in Progress...

- ▶ Measurement of the oil level not yet possible. Repeat the query after driving for a maximum of 30 minutes.

Engine Oil Level OK

The bar for displaying the oil level on the display is green and is between "min" and "max".

- ▶ Do not refill oil. The engine oil level is correct.

Engine Oil Level Warm Up Engine

- ▶ Warm up the engine to operating temperature.

Engine Oil Level Correct Measurement Only if Vehicle Is on Level Ground

- ▶ Park the vehicle on a level surface.

Engine Oil Level Add 1.0 l

The bar for displaying the oil level on the display is orange and is below "min".

The oil level is too low.

- ▶ Add 1.1 US qt (1 l) of engine oil (→ page 179).

Reduce Engine Oil Level

The bar for displaying the oil level on the display is orange and is above "max".

The oil level is too high.

- ▶ Siphon off any excess engine oil that has been added. To do so, consult a qualified specialist workshop.

For Engine Oil Level Ignition Must Be On

- ▶ Switch the ignition on to check the engine oil level.

Engine Oil Level System Inoperative

The fill level sensor is defective or not plugged in.

- ▶ Have the oil level display checked at a qualified specialist workshop.

Engine Oil Level System Currently Unavail.

- ▶ Close the hood.

- ⓘ Vehicles with cold oil level display: after the vehicle has been out of use for an extended time, the oil level will automatically be shown on the display. If it is not possible to measure the engine oil level, a message to that effect will appear.

Checking the engine oil level with a dipstick

⚠ WARNING Risk of burns from hot component parts in the engine compartment

Certain component parts in the engine compartment can be very hot, e.g. the engine, the cooler and parts of the exhaust system.

- ▶ Allow the engine to cool down and only touch component parts described in the following.

The engine oil becomes dirty during operation, loses quality and also gradually loses volume. Check the oil level regularly and add oil or have it changed if necessary.

Regularly check the fluid level and the major assemblies for leaks. If you detect fluid loss, for example, oil drops on the vehicle parking space,

consult a qualified specialist workshop as quickly as possible.

- ▶ Only check the oil level when the engine is at normal operating temperature.

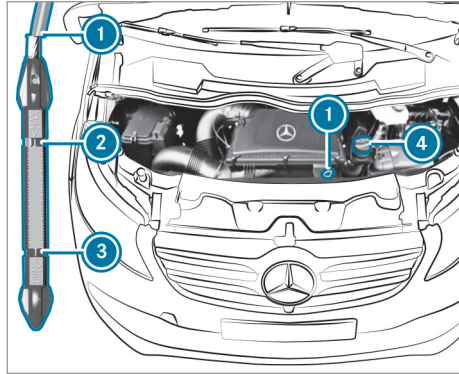

Oil dipstick and engine oil filler opening (example: gasoline engine)

- ▶ Pull oil dipstick ① out of the dipstick tube.
- ▶ Wipe the oil dipstick ① using a lint-free cloth.
- ▶ Insert the oil dipstick ① back into the guide tube as far as it will go and pull it out again. If the level is between MIN mark ③ and MAX mark ②, the oil level is adequate.
- ▶ If the oil level has dropped to or below minimum mark ③, open cap ④ and add engine oil (→ page 179).

The difference in quantity between marks ② and ③ is approximately 1.6 US qt (1.5 liters) in the case of gasoline engines.

Adding engine oil

⚠ WARNING Risk of fire and injury from engine oil

If engine oil comes into contact with hot component parts in the engine compartment, it may ignite.

- ▶ Make sure that no engine oil is spilled next to the filler opening.
- ▶ Allow the engine to cool off and thoroughly clean the engine oil from component parts before starting the vehicle.

⚠ WARNING Risk of burns from hot component parts in the engine compartment

Certain component parts in the engine compartment can be very hot, e.g. the engine, the cooler and parts of the exhaust system.

- ▶ Allow the engine to cool down and only touch component parts described in the following.

! NOTE Damage caused by refilling too much engine oil

Too much engine oil can damage the engine or the catalytic converter.

- ▶ Have excess engine oil removed at a qualified specialist workshop.

! NOTE Engine damage due to use of additives in the engine oil

The use of additional additives in the engine oil can damage the engine.

- ▶ Do not use any additional additives in the engine oil.

🔥 ENVIRONMENTAL NOTE Environmental damage caused by spilling oil when refilling

Damage is caused to the environment if spilled oil enters the soil.

- ▶ When refilling oil, make sure none is spilled.

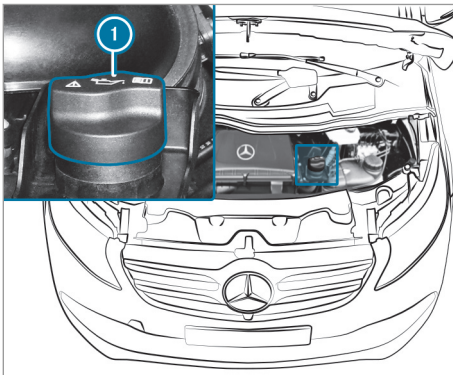

Example: engine oil filler opening

- ▶ Observe the information regarding approved engine oil under "Operating fluids and capacities" (→ page 228).

- ▶ Unscrew and remove cap ①.

- ▶ Refill engine oil.

- ▶ Place cap ① on the filler opening and tighten.

When doing so, make sure that the cap engages correctly.

- ▶ If present, check the oil level using the oil dipstick (→ page 179).

- ▶ In the case of vehicles without an oil dipstick, check the oil level with the on-board computer after the next journey (→ page 178).

It is necessary to run the engine for an extended period after each oil refill to correctly detect the oil level. Fill level changes during oil refills may not be immediately visible. Depending on the driving profile, the new oil level can only be displayed after a driving time of up to 60 minutes.

If necessary, only refill the quantity of oil shown in the instrument cluster display and check the oil level again after the next journey.

Checking/adding coolant

⚠ WARNING - Risk of fire and injury from antifreeze

If antifreeze comes into contact with hot component parts in the engine compartment, it may ignite.

- ▶ Allow the engine to cool down before adding antifreeze.
- ▶ Make sure that no antifreeze spills out next to the filler opening.
- ▶ Thoroughly clean off any antifreeze from component parts before starting the vehicle.

⚠ WARNING Risk of scalding from hot coolant

If you open the cap, you could be scalded.

- ▶ Let the motor cool down before opening the cap.
- ▶ When opening the cap, wear protective gloves and safety glasses.
- ▶ Open the cap slowly to release pressure.

Only check the coolant level and/or fill the coolant if the vehicle is stationary, on a level surface and the engine has cooled down. The coolant temperature must be below 122°F (50°C).

⚠ WARNING Risk of burns from hot component parts in the engine compartment

Certain component parts in the engine compartment can be very hot, e.g. the engine, the cooler and parts of the exhaust system.

- ▶ Allow the engine to cool down and only touch component parts described in the following.

- ▶ Coolant contains glycol and is therefore poisonous. Observe the information under "Operating fluids and capacities" (→ page 230).

! NOTE Paintwork damage due to coolant

If coolant gets on painted surfaces, the paintwork can be damaged.

- ▶ Add coolant carefully.
- ▶ Remove spilled coolant.

Regularly check the engine cooling system and the heating system for leaks. If there is a loss of coolant, have the cause determined and rectified in a qualified specialist workshop without delay.

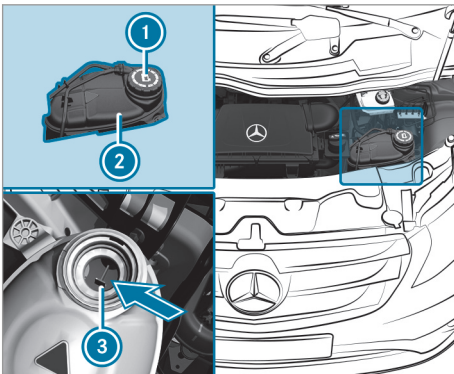

Example: cap and coolant expansion reservoir

Checking the coolant level

- ▶ Slowly turn cap ① of coolant expansion reservoir ② half a turn counter-clockwise and allow overpressure to escape.
- ▶ Turn cap ① further and remove it.

The coolant level is correct in the following cases:

- Up to marker bar ③ when the engine is cold
- If the engine is warm, up to 0.6 in (1.5 cm) over marker bar ③

Adding coolant

Only use coolant approved for Mercedes-Benz to avoid damaging the engine cooling system.

- ▶ Refer to the information on coolant (→ page 230).
- ▶ Refill the coolant up to marker bar ③ in the filler opening of coolant expansion reservoir ②.
- ▶ Replace cap ① and tighten in a clockwise direction.
- ▶ Start the engine.
- ▶ Set the temperature in the vehicle interior to the maximum output on the control panel of the climate control.
- ▶ After approximately five minutes, switch off the engine again and allow it to cool down.
- ▶ Check the coolant level again and add coolant if necessary.

Refilling the windshield washer system

⚠ WARNING Risk of fire and injury from windshield washer concentrate

Windshield washer concentrate is highly flammable.

- ▶ Avoid fire, open flames, smoking and the creation of sparks when using windshield washer concentrate.

⚠ WARNING Risk of burns from hot component parts in the engine compartment

Certain component parts in the engine compartment can be very hot, e.g. the engine, the cooler and parts of the exhaust system.

- ▶ Allow the engine to cool down and only touch component parts described in the following.

! NOTE Damage to the exterior lighting due to unsuitable windshield washer fluid

Unsuitable windshield washer fluid may damage the plastic surface of the exterior lighting.

- ▶ Only use windshield washer fluids that are also suitable for use on plastic sur-

faces, e.g. MB SummerFit or MB Winter-Fit.

Refilling washer fluid

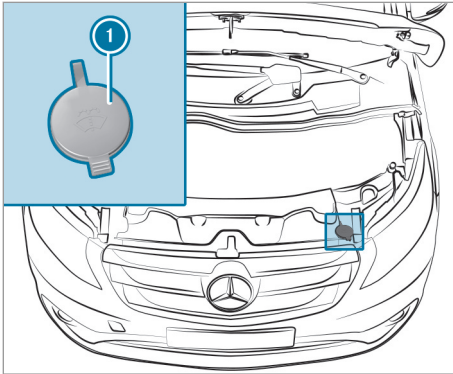

Washer fluid reservoir (example)

- ▶ Observe the notes on washer fluid (→ page 231).
- ▶ Pull cap ① upwards by the tab.
- ▶ Add washer fluid .
- ▶ Push cap ① onto the filler opening until it audibly engages.

Cleaning and care

Notes on washing the vehicle in an automatic car wash

⚠ WARNING Risk of accident due to reduced braking effect after washing the vehicle

The braking effect is reduced after washing the vehicle.

- ▶ After the vehicle has been washed, brake carefully while paying attention to the traffic conditions until the braking effect has been fully restored.

! **NOTE** Damage to the vehicle due to automatic braking

When the following functions are activated, the vehicle brakes automatically in certain situations:

- Active Brake Assist
- Active Distance Assist DISTRONIC
- HOLD function

To avoid damage to the vehicle, deactivate these systems in the following or similar situations:

- ▶ When towing
- ▶ In a car wash

! **NOTE** Damage due to unsuitable car wash

- ▶ Before driving into a car wash make sure that the car wash is suitable for the vehicle dimensions.
- ▶ Ensure there is sufficient ground clearance between the underbody and the guide rails of the car wash.
- ▶ Ensure that the clearance width of the car wash, in particular the width of the guide rails, is sufficient.

To avoid damage to your vehicle, observe the following before using an automatic car wash:

- Active Brake Assist is deactivated.
- Active Distance Assist DISTRONIC is deactivated.
- The HOLD function is switched off.
- The side windows and roof are completely closed.
- The outside mirrors are folded in and an additional antenna is removed, if present.
- The climate control blower is switched off.
- The windshield wiper switch is in position **0**.

If the vehicle is very dirty, wash off excess dirt before cleaning the vehicle in an automatic car wash.

After leaving the car wash, pay attention to the following:

- The outside mirrors are fully folded out again and an additional antenna is mounted again.
- Wax residues on the windshield and wiper rubbers are removed to prevent smearing and reduce wiper noise.

Remove wax residues from the camera lens in vehicles with a rear view camera (→ page 184).

Notes on use of a power washer

⚠ WARNING Risk of an accident when using power washers with round-spray nozzles

The water jet can cause externally invisible damage.

Components damaged in this way may unexpectedly fail.

- ▶ Do not use a power washer with round-spray nozzles.
- ▶ Have damaged tires or chassis parts replaced immediately.

! NOTE Damage to component parts due to improper high-pressure cleaning

Components can be damaged if the distance of the high-pressure nozzle is too small.

- ▶ Maintain a minimum distance of about 12 in (30 cm) between the high-pressure nozzle and car parts.
- ▶ Do not use a power washer with a round-spray nozzle.
- ▶ Keep the water jet moving constantly while cleaning.
- ▶ Do not clean the following components with the power washer:
 - Electrical components
 - Plug connectors
 - Rear view camera
 - Drivetrain
 - Seals
 - Hoses

! NOTE Damage caused by the use of a power washer in the vehicle interior

The pressurized water created by the power washer and the associated spray could cause considerable damage to the vehicle.

- ▶ Never use a power washer in the vehicle interior.

! NOTE Damage to the exhaust gas after-treatments through incorrect cleaning

Cleaning the system when warm or the effects of direct water jets into the exhaust pipe can damage the exhaust gas after-treatment.

- ▶ Only clean the system when the system is cold.
- ▶ Do not direct the water jet into the exhaust pipe.

Washing the engine

! NOTE Damage and malfunctions due to washing the engine

- ▶ To prevent damage and malfunctions of the engine, observe the following points:
 - When using high-pressure or steam cleaners, do not point the water jet directly at electrical components and the end of electric cables.
 - Make sure that no water enters the vent and ventilation openings.
 - Use preservative agents in the engine after washing the engine.
 - Protect the belt drive from preservative agents.

Washing the vehicle by hand

Observe the legal requirements, for example in many countries washing by hand is only allowed at specially designated wash bays.

- ▶ Wash the vehicle with lukewarm water and a soft car sponge. When doing so, do not expose the vehicle to direct sunlight.
- ▶ Use a mild cleaning agent, e.g. a Mercedes-Benz approved car shampoo.

- ▶ Carefully spray the vehicle with water and dry off with a leather cloth. Do not point the water jet directly into the air inlet grille.

When operating the vehicle in winter, remove all traces of road salt deposits carefully and as soon as possible.

Notes on care of paint and matte finish

! **NOTE** Paintwork damage and corrosion due to inadequate care

Failure to promptly and thoroughly remove dirt from bird droppings or other residue could result in paintwork damage and corrosion at a later date.

- ▶ Clean dirt off paint and matte finish thoroughly and as soon as possible.

Observe the notes on cleaning and care in order to avoid damage to the paintwork.

Paint

- Insect remains: soak with insect remover and then wash off.
- Bird droppings: soak with water and then wash off.
- Tree resin, oils, fuels and greases: remove by rubbing gently with a cloth soaked in petroleum ether or lighter fluid.
- Coolant and brake fluid: remove with a damp cloth and clear water.
- Tar stains: use tar remover.
- Wax: use a silicone remover.
- Do not affix stickers, films or similar.
- Remove dirt as soon as possible.

Matte finish

- Only use care products approved for Mercedes-Benz.
- Do not polish the vehicle and alloy wheels.
- Only use state-of-the-art car washes.
- Do not use a wash program that ends with a hot wax treatment in automatic car washes.
- Do not use paint cleaners, buffing or polishing products, or gloss preservers, e.g. wax.
- Always have paintwork repairs carried out at a qualified specialist workshop.

Notes on the care of vehicle parts

! **WARNING** Risk of injury if unsuitable climbing aids are used

If you use openings in the vehicle's body work or detachable parts as steps, you could:

- Slip and/or fall.
- Damage the vehicle and thus slip and fall.

- ▶ Always use anti-slip, stable climbing aids, e.g. a suitable ladder.

! **WARNING** Risk of entrapment if the windshield wipers are switched on while the windshield is being cleaned

If the windshield wipers are set in motion while you are cleaning the windshield or wiper blades, you can be trapped by the wiper arm.

- ▶ Always switch off the windshield wipers and the ignition before cleaning the windshield or wiper blades.

! **WARNING** Risk of burns from the tailpipe and tailpipe trims

The exhaust tailpipe and tailpipe trims can become very hot. If you come into contact with these parts of the vehicle, you could burn yourself.

- ▶ Always be particularly careful around the tailpipe and the tailpipe trims and supervise children especially closely in this area.
- ▶ Allow vehicle parts to cool down before touching them.

! **NOTE** Damage caused by the use of openings in the bodywork or detachable part as a step

Using the lower guide of the sliding door (carriage) as a step can damage the trim and/or mechanism of the sliding door.

- ▶ Do not use the guide of the sliding door (carriage) as a step.

- ① Information on suitable cleaning agents or cleaning cloths can be obtained from a qualified specialist workshop.

To avoid damage to the vehicle, follow the instructions for cleaning and care of the following vehicle parts:

Wheels and rims

- Use water and acid-free alloy wheel cleaner.
- Do not use acidic alloy wheel cleaners to remove brake dust. Otherwise, wheel bolts and brake components could be damaged.
- To avoid corrosion of brake discs and brakepads, drive for a few minutes after cleaning before parking the vehicle. The brake discs and brakepads warm up and dry out.

Windows

- Clean the windows inside and outside with a damp cloth and with a cleaning agent recommended for Mercedes-Benz.
- Do not use dry cloths or abrasive or solvent-based cleaning agents to clean the inside of windows.

Wiper blades

- Carefully clean the folded-away wiper blades with a damp cloth.
- Fold wiper arm away from the rear window (→ page 87).
- Do not clean the wiper blades too often.

Exterior lighting

- Clean the covers with a wet sponge and mild cleaning agent, e.g. car shampoo.
- Only use cleaning agents or cloths suitable for plastic covers.

Sensors

- Clean the sensors in the front and rear bumpers with a soft cloth and car shampoo (→ page 110).
- When using a power washer, keep a minimum distance of 12 in (30 cm).

Rear view camera

- **Vehicles with a tailgate:** switch on the ignition and shift the transmission to the **[R]** position to open the camera cover when the engine is switched off (→ page 110).
- Use clean water and a soft cloth to clean the camera lens.
- Do not use a power washer.

Sliding door

- Remove foreign objects from the vicinity of the contact plates and contact pins of the sliding door.
- Clean the contact plates and contact pins with a mild cleaning agent and a soft cloth.
- Do not oil or grease the contact plates and the contact pins.

Tailpipes

- Clean with a cleaning agent recommended for Mercedes-Benz, especially in the winter and after washing the vehicle.
- Do not use acidic cleaning agents.

Trailer hitch

Observe the notes on care in the trailer hitch manufacturer's operating instructions.

Notes on interior care

⚠ WARNING Risk of injury from plastic parts breaking off after the use of solvent-based care products

Care and cleaning products containing solvents can cause surfaces in the cockpit to become porous. When the airbags are deployed, plastic parts may break away.

- ▶ Do not use any care or cleaning products containing solvents to clean the cockpit.

⚠ WARNING Risk of injury or death from bleached seat belts

Bleaching or dyeing seat belts can severely weaken them.

This can, for example, cause seat belts to tear or fail in an accident.

- ▶ Never bleach or dye seat belts.

To avoid damage to the vehicle, observe the following instructions for cleaning and care:

Seat belts

- Clean with lukewarm soapy water.
- Do not use chemical cleaning agents.
- Do not dry by heating above 176 °F (80 °C) or in direct sunlight.

Display

- Switch off the display and let it cool down.
- Clean the surface carefully with a microfiber cloth and a suitable display care product (TFT-LCD).
- Do not use any other agents.

Plastic trim

- Clean with a damp microfiber cloth.
- For heavy soiling: use a cleaning agent recommended for Mercedes-Benz.
- Do not affix stickers, films or similar.
- Do not allow to come into contact with cosmetics, insect repellent and sun creams.

Headliner

- Clean with a brush or dry shampoo.

Carpet

- Use a carpet and textile cleaning agent recommended for Mercedes-Benz.

Genuine leather seat covers

- Clean with a damp cloth and then wipe with a dry cloth.
- Leather care: use a leather care agent recommended for Mercedes-Benz.
- Do not clean the leather with too much liquid.
- Do not use a microfiber cloth.

Seat covers made of artificial leather

- Clean with a damp cloth and 1% soapy water.
- Do not use a microfiber cloth.

Cloth seat covers

- Clean with a damp microfiber cloth and 1% soap solution and allow to dry.

Genuine leather steering wheel

! **NOTE** Damage caused by wrong cleaners

▶ Do not use solvent-based cleaning agents such as tar remover or wheel cleaner; neither should you use polishes or waxes. Otherwise you may damage the finish.

- Clean with a damp cloth and 1% soapy water and wipe with a dry cloth.
- For heavy soiling: use a cleaning agent recommended for Mercedes-Benz.
- Vehicles with leather upholstery: use a leather care agent recommended for Mercedes-Benz.

- Do not clean the leather with too much liquid.
- Do not use a microfiber cloth.

i Leather is a natural product. It has natural surface characteristics, e.g. differences in structure, traces of growth and injury or slight color nuances.

Real wood and trim elements

- Clean with a microfiber cloth.
- Black piano-lacquer look: clean with a damp cloth and soapy water.
- For heavy soiling: use a cleaning agent recommended for Mercedes-Benz.
- Do not use solvent-based cleaning agents, polishes or waxes.

Emergency

Removing the safety vest

The safety vest is located in the door storage compartment in the driver's door.

- ▶ Take the safety vest out of the door storage compartment.
- ① Safety vests can also be stored in the door storage compartment of the co-driver's door.

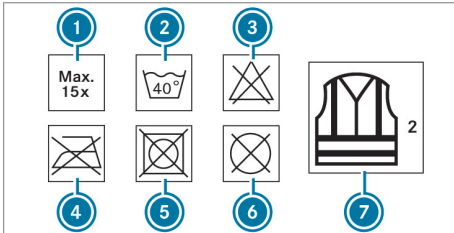

- ① Maximum number of washes
- ② Maximum wash temperature
- ③ Do not bleach
- ④ Do not iron
- ⑤ Do not tumble dry
- ⑥ Do not dry-clean
- ⑦ This is a class 2 vest

The safety vest only fulfills the legally required standards if it is the correct size and is completely closed.

Replace the safety vest in the following cases:

- If damaged or if the reflective strips are dirty
- If the maximum permitted number of washes is exceeded
- If the safety vest's fluorescence has faded

Removing the first-aid kit (soft sided)

The first-aid kit (soft sided) is located in the storage compartment in the co-driver door.

- ▶ Remove first-aid (soft sided) kit from the storage compartment.

Check the expiration date on the first-aid kit (soft sided) at least once a year. Replace any expired or missing contents.

Observe the legal requirements of the country in which you are currently driving.

Mercedes-Benz emergency call system

Information on the Mercedes-Benz emergency call system

▲ WARNING Risk of distraction from information systems and communications equipment

If you operate information and communication equipment integrated in the vehicle when driving, you will be distracted from the traffic situation. This could also cause you to lose control of the vehicle.

- ▶ Only operate this equipment when the traffic situation permits.
- ▶ If you cannot be sure of this, stop the vehicle whilst paying attention to road and traffic conditions and operate the equipment with the vehicle stationary.

Observe the legal requirements for the country in which you are staying.

The Mercedes-Benz emergency call system only functions in areas where mobile phone coverage is available from the relevant contract partner. Insufficient network coverage from the relevant contract partner may result in an emergency call not being transmitted.

The Mercedes-Benz emergency call system can help to decisively reduce the time between an accident and the arrival of emergency services at the site of the accident. It helps locate an accident site in places that are difficult to access.

An emergency call can be initiated automatically or manually using the SOS button (→ page 188).



Only make emergency calls if you or others are in need of rescue. Do not make an emergency call in the event of a breakdown or a similar situation.

Additional information on the transferred data (→ page 189).

You can find more information on the regional availability of the Mercedes-Benz emergency call system at: <https://www.mercedes-benz-mobile.com/extra/ecall/>

Displays in the instrument cluster

After the ignition is switched on, a message appears in the instrument cluster indicating whether your vehicle can be located.

On vehicles without steering wheel buttons, the  **Tracking Active** or  **Tracking not Active** message briefly appears.

On vehicles with steering wheel buttons, the  symbol is only then shown in the status area if the positioning function is active.

SOS NOT READY: The ignition is not switched on or the emergency call system is malfunctioning.

SOS READY: The emergency call system is available again, after a malfunction for example.

During an active emergency call the  symbol and various messages about the status of the emergency call appear in the display.

If the emergency call system is malfunctioning, the instrument cluster displays a corresponding message.

Triggering an automatic Mercedes-Benz emergency call

Requirements:

- The ignition is switched on.
- The starter battery is sufficiently charged.

If restraint systems such as airbags or Emergency Tensioning Devices have been activated after an accident, eCall may automatically initiate an emergency call.

When the emergency call is made:

- A voice connection is made to the Mercedes-Benz emergency call center.
 - A message with accident data is transmitted to the Mercedes-Benz emergency call center.
- The Mercedes-Benz emergency call center can transmit the vehicle position data to one of the emergency call centers.

The SOS button in the overhead control panel flashes until the emergency call is finished.

It is not possible to immediately end an automatic emergency call.

If no connection can be made to the emergency services:

- ▶ Dial the local emergency number on your mobile phone.

If an emergency call has been initiated:

- Remain in the vehicle if the road and traffic conditions permit you to do so until a voice

connection is established with the emergency call center operator.

- Based on the call, the operator decides whether it is necessary to call rescue teams and/or the police to the accident site.
- If no vehicle occupant answers, an ambulance is sent to the vehicle immediately.

Triggering a manual emergency call

Requirements:

- The ignition is switched on.
- The starter battery is sufficiently charged.

If restraint systems such as airbags or Emergency Tensioning Devices are activated during an accident, the Mercedes-Benz emergency call system automatically initiates an emergency call.

Initiating an emergency call manually using the SOS button in the overhead control panel

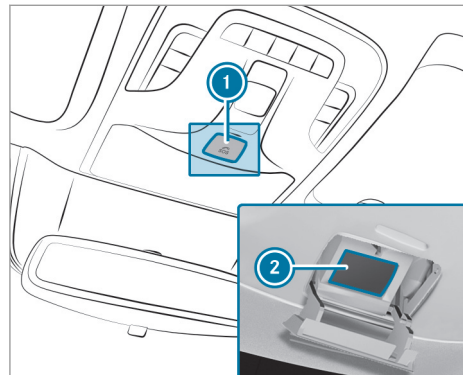

- ▶ To open, briefly press cover ① for SOS button ②.
- ▶ Press and hold the SOS button for at least one second. The indicator lamp in SOS button ② flashes until the emergency call is finished.

When the emergency call is made:

- A voice connection is made to the Mercedes-Benz emergency call center.
- A message with the accident data is transmitted to the Mercedes-Benz emergency call center.



The Mercedes-Benz emergency call center can transmit the vehicle position data to one of the public emergency services call centers.

- Remain in the vehicle if the road and traffic conditions permit you to do so until a voice connection is established with the emergency call center operator.
- Based on the call, the operator decides whether it is necessary to call rescue teams and/or the police to the accident site.
- In certain situations data is also transmitted in the voice channel to the Mercedes-Benz emergency call center.

This allows measures for rescue, recovery or towing to a Mercedes-Benz Commercial Van Center to be initiated quickly.

If the Mercedes-Benz emergency call system cannot connect to the Mercedes-Benz emergency call center, the emergency call is automatically sent to the public emergency services call center. If no connection can be made to the public emergency services, a corresponding message appears in the display. In this case you must dial the emergency call number **112** on your mobile phone.

Ending an unintentional emergency call

- ▶ **Vehicles without steering wheel buttons:** press the  button in the instrument cluster.
- ▶ **Vehicles with steering wheel buttons:** press the  button on the steering wheel.
- ▶ Close the SOS button cover

Data transfer of the Mercedes-Benz emergency call system

In the event of an automatic or manual emergency call, as well as for a **112** emergency call, data is transmitted to the Mercedes-Benz emergency call center or the public emergency services call center.

The following data is transmitted:

- Vehicle's GPS position data
- (GPS position data on the route (a few hundred meters before the incident))
- Direction of travel
- Vehicle identification number
- Vehicle drive type
- Number of persons on the front seats
- Whether the emergency call was initiated manually or automatically
- Time of the accident
- Language setting

For accident clarification purposes, the following measures can be taken up to an hour after the emergency call has been initiated:

- The current vehicle position can be called up
- A voice connection to the vehicle occupants can be established

Flat tire

Notes on flat tires

⚠ WARNING Risk of accident due to a flat tire

A flat tire affects the driving characteristics of the vehicle.

- ▶ Do not drive with a flat tire.
- ▶ Replace the flat tire with the emergency spare wheel or spare wheel. Alternatively, consult a qualified specialist workshop.

You will find a sticker with the Mercedes-Benz Service24h telephone number on the B-pillar on the driver's side, for example.

For vehicles with a spare wheel, information in the event of a flat tire can be found under "Wheels and tires" (→ page 216).

Battery

Notes on the starter battery

Work on the battery, e.g. removing or installing, requires specialist knowledge and the use of special tools. Therefore, always have work on the battery carried out at a qualified specialist workshop.

⚠ WARNING Risk of an accident due to work carried out incorrectly on the battery

Work carried out incorrectly on the battery can, for example, lead to a short circuit. This can restrict functions relevant for safety systems and impair the operating safety of your vehicle.

You could lose control of the vehicle in the following situations in particular:

- When braking
- In the event of abrupt steering maneuvers and/or when the vehicle's speed is not adapted to the road conditions
- ▶ In the event of a short circuit or a similar incident, contact a qualified specialist workshop immediately.
- ▶ Do not drive on.
- ▶ Always have work on the battery carried out at a qualified specialist workshop.

- Further information on ABS (→ page 111)
- Further information on ESP® (→ page 111)

For safety reasons, Mercedes-Benz recommends that you only use batteries that have been tested and approved for your vehicle by Mercedes-Benz. These batteries provide increased impact protection to prevent vehicle occupants from suffering acid burns should the battery be damaged in an accident.

▲ WARNING Risk of explosion due to electrostatic charge

Electrostatic charge can ignite the highly explosive gas mixture in the battery.

- ▶ To discharge any electrostatic charge that may have built up, touch the metal vehicle body before handling the battery.

The highly flammable gas mixture is created while the battery is charging and when jump-starting. Make sure that neither you nor the battery is electrostatically charged.

Electrostatic charge can occur in the following cases, for example:

- You are wearing synthetic clothing.
- There is friction between your clothing and the seat.
- You drag or push the battery across a carpet or other synthetic materials.
- You rub the battery with cloths or towels.

▲ WARNING Danger of chemical burns from the battery acid

Battery acid is caustic.

- ▶ Avoid contact with the skin, eyes or clothing.
- ▶ Do not lean over the battery.
- ▶ Do not inhale battery gases.
- ▶ Keep children away from the battery.
- ▶ Immediately rinse battery acid off thoroughly with plenty of clean water and seek medical attention immediately.

🌿 ENVIRONMENTAL NOTE Environmental damage due to improper disposal of batteries



Batteries contain pollutants. It is illegal to dispose of them with the household rubbish.



Dispose of batteries in an environmentally responsible manner. Take discharged batteries to a qualified specialist workshop or to a collection point for used batteries.

Observe the safety notes and protective measures when handling batteries.



Risk of explosion



Fire, open flames and smoking are prohibited when handling the battery. Avoid creating sparks.



Electrolyte or battery acid is corrosive. Avoid contact with the skin, eyes and clothing. Wear suitable protective clothing, in particular gloves, an apron and a safety mask. Immediately rinse electrolyte acid splashes off with clean water. If necessary, seek medical advice.



Wear eye protection.



Keep children at a safe distance.



Observe these Operating Instructions.

Observe the following notes:

- Recharge the battery more frequently in the following cases:
 - You predominantly drive short distances.
 - You predominantly drive at low outside temperatures.
 - You leave the vehicle parked for a lengthy period.

In order for the batteries to achieve their maximum possible service life, they must always be sufficiently charged.

- Consult a qualified specialist workshop if you wish to leave your vehicle parked up for a long period of time.
- When you park the vehicle, remove the key if you do not require any electrical consumers. The vehicle will then use very little energy, thus conserving battery power.
- If your vehicle requires jump-starting, or if you wish to provide jump-starting assistance to another vehicle, only use the jump-start connection point in the engine compartment (→ page 191).

Installation locations

Your vehicle may be equipped with the following three batteries, depending on the equipment version:

- Starter battery in the seat base of the right-hand front seat
- Support battery in the seat base of the right-hand front seat
- Auxiliary battery in the seat base of the left-hand front seat

Starting assistance and charging the 12 V battery

⚠ WARNING Risk of explosion from a frozen battery

A discharged battery may freeze at temperatures slightly above or below freezing point.

During starting assistance or battery charging, battery gas can be released.

- ▶ Always allow a battery to thaw before charging it or performing starting assistance.

If the warning/indicator lamps do not light up in the instrument cluster at temperatures around or below freezing, it is highly probable that the discharged battery has frozen.

In this case, observe the following points:

- Do not give the vehicle starting assistance or charge the battery
- The service life of a battery that has been thawed may be reduced drastically
- The starting behavior may deteriorate, particularly at low temperatures
- It is recommended that you have a thawed battery checked at a qualified specialist workshop

⚠ WARNING Risk of explosion during charging process and starting assistance

During the charging process and starting assistance, the battery may release an explosive gas mixture.

- ▶ Avoid fire, open flames, creating sparks and smoking.
- ▶ Make sure there is sufficient ventilation.
- ▶ Do not lean over a battery.

⚠ WARNING Danger of chemical burns from the battery acid

Battery acid is caustic.

- ▶ Avoid contact with the skin, eyes or clothing.
- ▶ Do not lean over the battery.
- ▶ Do not inhale battery gases.
- ▶ Keep children away from the battery.

- ▶ Immediately rinse battery acid off thoroughly with plenty of clean water and seek medical attention immediately.

Starting assistance

! **NOTE** Damage caused by numerous or extended attempts to start the engine

Numerous or extended attempts to start the engine may damage the catalytic converter due to non-combusted fuel.

- ▶ Avoid numerous and extended attempts to start the engine.

Do not use a rapid charging device to start the vehicle. If your vehicle's battery is discharged, the engine can be jump-started from another vehicle or from a donor battery using jumper cables. For this purpose, the vehicle has a jump-start connection point in the engine compartment.

When jump-starting, observe the following points:

- The battery is not accessible in all vehicles. If the other vehicle's battery is not accessible, starting assistance is to be provided using a donor battery or a starting assistance device.
- You may only jump-start the vehicle when the engine and exhaust system are cold.
- Do not start the engine if the battery is frozen. Let the battery thaw first.
- Starting assistance may only be provided using batteries with a nominal voltage of 12 V.
- Only use jumper cables that have a sufficient cross-section and insulated terminal clamps.
- If the battery is fully discharged, attach the donor battery for a few minutes before attempting to start. This charges the discharged battery a little.
- Make sure that the two vehicles do not touch.

Jumper cables and further information regarding starting assistance can be obtained at any qualified specialist workshop.

Ensure the following before connecting the jumper cables:

- The jumper cables are not damaged.
- Parts of the terminal clamps which are not insulated do not come into contact with other

metal parts while the jumper cables are connected to the battery.

- The jumper cables do not touch moving parts when the engine is started and while it is running, such as the V-belt pulley or the fan.
- ▶ Apply the parking brake.
 - ▶ Shift the transmission to position **P**.
 - ▶ Switch off all electrical consumers, e.g. audio device, blower.
 - ▶ Switch off the ignition immediately and remove the key.
 - ▶ Open the hood (→ page 176).

Connecting and disconnecting the jumper cables

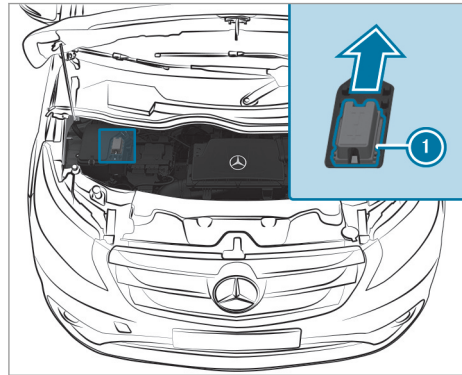

Example: jump-start connection point

- ▶ Push contact protection cover **1** of the jump-start connection point towards the rear of the vehicle against the spring pressure as far as it will go. The jump-start connection point is visible.

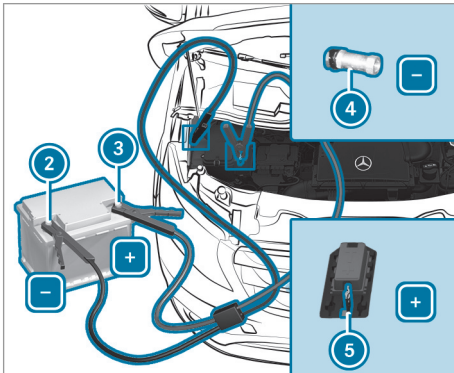

Terminal connection diagram

- ▶ Remove the cover from positive terminal ③ of the donor battery.
- ▶ Connect the positive terminal clamp of the jumper cable to positive terminal ③ of the donor battery, and then to positive terminal ⑤ of the jump-start connection point.
- ▶ Connect the negative terminal clamp of the jumper cable to negative terminal ② of the donor battery, and then to ground contact ④ of your own vehicle.
- ▶ Start the engine of the donor vehicle and run it at idling speed.
- ▶ Insert the key into the ignition lock, start the engine and let it run for several minutes.
- ▶ Before disconnecting the jumper cables, switch on an electrical consumer in your own vehicle, e.g. the rear window heater or the lighting.
- ▶ Disconnect the negative terminal clamp of the jumper cable from ground contact ④ and then from negative terminal ② of the donor battery.
- ▶ Disconnect the positive terminal clamp of the jumper cable from positive terminal ⑤ on the jump-start connection point, and then from positive terminal ③ of the donor battery.
Contact protection cover ① is automatically returned forwards to its original position by the spring force and the jump-start connection point is closed.
- ▶ Position the cover on positive terminal ③ of the donor battery.
- ▶ Have the battery checked at a qualified specialist workshop.

Charging the 12 V battery

- ! **NOTE** Damage to the electronics caused by non-approved charging devices

Charging an installed battery with a battery charger which has not been approved by Mercedes-Benz can damage the on-board electronics.

- ▶ Only use a battery charger which has been approved by Mercedes-Benz and which permits charging the battery when it is installed in the vehicle.
- ▶ Only charge the battery using the jump-start connection point.

A battery charger specially adapted for Mercedes-Benz vehicles and tested and approved for Mercedes-Benz is available as an accessory.

Further information is available from any Mercedes-Benz Commercial Van Center. Read the operating instructions for your charger before charging the battery.

Recharge the battery more frequently if you use the vehicle mainly for short trips and/or drive at low outside temperatures.

- ▶ Connect the battery charger to the positive terminal and ground contact in the same order as when connecting the donor battery in the jump-starting procedure.
- i If a battery is not installed and not in service, you should charge it every three months. This helps to counteract self-discharging and prevent damage to the battery.

12 V battery care

- ! **NOTE** Battery discharging due to leakage current

Dirty battery clamps and battery surfaces cause leakage current. This can lead to the battery discharging.

- ▶ Keep the battery terminals and battery surfaces clean and dry.

- ! **NOTE** Damage to the battery housing due to improper cleaning

If you use cleaning agents containing fuel, these can damage the battery housing.

- ▶ Do not use cleaning agents containing fuel.

I NOTE Damage to the battery through self-discharging

If dirt enters the battery cell, battery self-discharging will accelerate and the battery may be damaged.

- ▶ Only clean batteries when the caps are screwed on.

Observe the following points on battery care:

- ▶ Regularly check the battery terminals and the fastening of the negative cable to the chassis to ensure that they are firmly seated.
- ▶ Lightly grease the undersides of the battery terminal clamps with acid-resistant grease.
- ▶ Only clean the battery housing with commercially available cleaning agents.

Disconnecting and removing the starter battery

A WARNING Risk of explosion from hydrogen gas igniting

There is a danger of hydrogen gas igniting when charging the battery if there is a short circuit or sparks start to form.

- ▶ Make sure that the positive terminal of the connected battery does not come into contact with vehicle parts.
- ▶ Never place metal objects or tools on a battery.
- ▶ The described order of the battery clamps must be observed when connecting and disconnecting the battery.
- ▶ When giving starting assistance, always make sure that you only connect battery terminals with identical polarity.
- ▶ During starting assistance, you must observe the described order for connecting and disconnecting the jumper cable.
- ▶ Do not connect or disconnect the battery clamps while the engine is running.

A WARNING Danger of chemical burns from the battery acid

Battery acid is caustic.

- ▶ Avoid contact with the skin, eyes or clothing.

- ▶ Do not lean over the battery.
- ▶ Do not inhale battery gases.
- ▶ Keep children away from the battery.
- ▶ Immediately rinse battery acid off thoroughly with plenty of clean water and seek medical attention immediately.

I NOTE Damage to electronic components due to work carried out incorrectly on the battery

If the starter battery is disconnected before the key is removed from the ignition lock, electronic components or assemblies, such as the alternator, can be damaged.

- ▶ Switch off the engine and remove the key from the ignition lock.
- ▶ Check to see that there are no indicator lamps lit in the instrument cluster.
- ▶ Always remove the negative terminal clamp first and then the positive terminal clamp.
- ▶ Do not interchange the battery clamps.

Always have work on the battery carried out at a qualified specialist workshop.

If, in exceptional circumstances, you must disconnect the battery yourself, pay attention to the following:

- Observe the notes on the 12 V battery (→ page 189).
- Secure the vehicle to prevent it from rolling away.
- For vehicles with an automatic transmission, the transmission is locked in position **P** after disconnecting the battery. You can then no longer move the vehicle.
- The battery and the cover of the positive terminal clamp must be installed securely during operation.

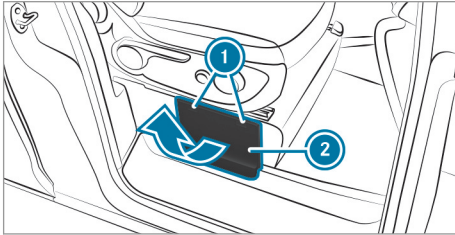

Seat base (example: right-hand front seat)

The following description on connecting and installing the battery uses the example of the starter battery in the seat base of the right-hand front seat.

The auxiliary battery is disconnected and removed in the same way as the starter battery. The auxiliary battery is located in the seat base of the left-hand front seat.

- ▶ Switch off all electrical consumers.
- ▶ Switch off the engine and remove the key from the ignition lock.
- ▶ Open the front right-hand door.
- ▶ Press both catch springs ① down and remove cover ② upwards from the seat base.
- ▶ Remove cover ② by pulling upwards at an angle from the seat base.

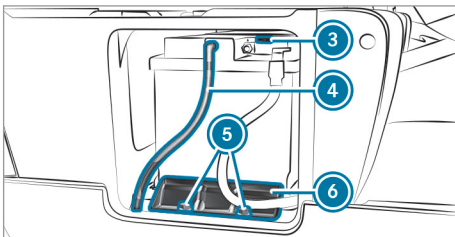

Open seat base (example: right-hand front seat)

- ▶ Remove screws ③ from holder ④.
- ▶ Remove holder ④.
- ▶ Remove vent hose ⑤ from the top of the battery.
- ▶ Pull the battery out of the seat base until the negative terminal clamp can be released and removed.
- ▶ Disconnect the negative terminal clamp from negative terminal ③.

- ▶ Remove the negative terminal clamp in such a way that the battery terminal clamp no longer touches negative terminal ③.

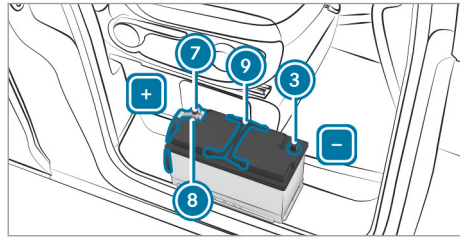

Example: starter battery

- ▶ Remove the battery from the seat base and place it on the door sill as shown. If necessary, hold the battery by handles ⑨.
- ▶ Remove the positive terminal clamp cover from positive terminal ⑦.
- ▶ Remove positive terminal clamp ⑧ from positive terminal ⑦.
- ▶ Remove positive terminal clamp ⑧ in such a way that the battery clamp no longer touches positive terminal ⑦.
- ▶ Lift the battery out of the door sill by handles ⑨.

Connecting and installing the starter battery

▲ WARNING Risk of explosion from hydrogen gas igniting

There is a danger of hydrogen gas igniting when charging the battery if there is a short circuit or sparks start to form.

- ▶ Make sure that the positive terminal of the connected battery does not come into contact with vehicle parts.
- ▶ Never place metal objects or tools on a battery.
- ▶ The described order of the battery clamps must be observed when connecting and disconnecting the battery.
- ▶ When giving starting assistance, always make sure that you only connect battery terminals with identical polarity.
- ▶ During starting assistance, you must observe the described order for connecting and disconnecting the jumper cable.

- ▶ Do not connect or disconnect the battery clamps while the engine is running.

! **NOTE** Damage to the on-board electronics due to interchanging the battery clamps

Incorrectly connecting the battery can damage the on-board electronics.

- ▶ Always connect the battery as described in the following sequence. Never reverse the terminal clamps.

The following description on connecting and installing the battery uses the example of the starter battery in the seat base of the right-hand front seat.

The auxiliary battery is connected and installed in the same way as the starter battery. The auxiliary battery is located in the seat base of the left-hand front seat.

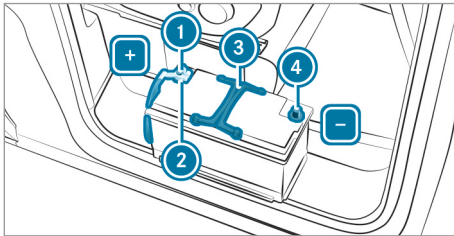

Example: starter battery

- ▶ Place the battery on the door sill as shown and secure with handles (3) if necessary.
- ▶ Connect positive terminal clamp (2) to positive terminal (1). The positive lead must be routed parallel to the side of the battery housing in the connection area, as shown.
- ▶ Place the positive terminal clamp cover on positive terminal (1).
- ▶ Fold both handles (3) down onto the battery.
- ▶ Push the battery into the seat base until the negative terminal clamp can be connected.
- ▶ Connect the negative terminal clamp to negative terminal (4).
- ▶ Push the battery into the seat base as far as it will go.

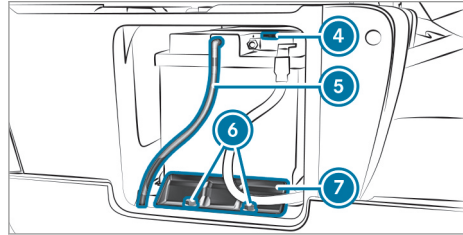

Open seat base with installed battery (example: right-hand front seat)

- ▶ Connect vent hose (5) to the battery connection at the top, beside negative terminal (4).
- ▶ Place holder (7) over the lower edge of the battery housing and the threaded holes for screws (6).
- ▶ Screw on holder (7) with screws (6). The battery is secured to prevent slipping.

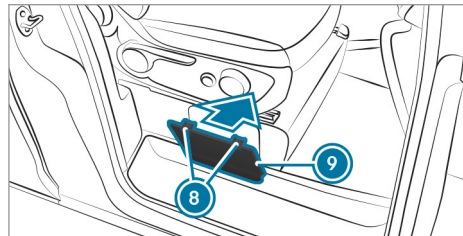

Seat base (example: right-hand front seat)

- ▶ Insert cover (9) in front of the battery compartment down into the seat base and close it. Catch springs (8) of cover (9) should engage audibly.

Carry out the following work after connecting the battery:

- ▶ Reset the side windows (→ page 58).
- ▶ Reset the outside mirrors (→ page 88).
- ▶ Reset the electric sliding doors (→ page 50).

Towing or tow-starting

Overview of permissible towing methods

⚠ WARNING Risk of accident due to limited safety-related functions during the towing process

Safety-related functions are limited or no longer available in the following situations:

- The ignition is switched off.
- The brake system or power steering system is malfunctioning.
- The energy supply or the on-board electrical system is malfunctioning.

When your vehicle is then towed away, significantly more effort may be required to steer and brake than is normally required.

- ▶ Use a tow bar.
- ▶ Make sure that the steering wheel can move freely before towing the vehicle away.

⚠ WARNING Risk of accident when towing with steering wheel lock

You will no longer be able to steer the vehicle if the steering wheel lock is engaged.

- ▶ Always switch on the ignition when towing the vehicle with a tow cable or a tow bar.

⚠ WARNING Risk of accident due to towing away a vehicle that is too heavy

If the vehicle being tow started or towed away is heavier than the permissible gross weight of your vehicle, the following situations may arise:

- The towing eye may become detached.
- The vehicle/trailer combination may even tip over.
- ▶ Before tow starting or towing away a vehicle, check that it does not exceed the permissible gross weight.

Details on the permissible gross vehicle weight of your vehicle can be found on the vehicle identification plate (→ page 226).

! **NOTE** Damage to the vehicle due to automatic braking

When the following functions are activated, the vehicle brakes automatically in certain situations:

- Active Brake Assist
- Active Distance Assist DISTRONIC
- HOLD function

To avoid damage to the vehicle, deactivate these systems in the following or similar situations:

- ▶ When towing
- ▶ In a car wash

! **NOTE** Damage due to incorrect connection of the tow bar or improper use of the towing device

- ▶ Only connect the tow rope or tow bar to the towing eyes or the trailer tow hitch.
- ▶ Do not use the towing eyes to recover a vehicle.

! **NOTE** Damage due to pulling force being too high

If you pull away abruptly, excessive pulling force could damage the vehicles.

- ▶ Pull away as straight, slowly and smoothly as possible.

! **NOTE** Damage due to improper towing with a tow rope

If you ignore safety and protective measures when towing with a tow rope, this can result in damage to the vehicle.

Observe the following points:

- ▶ Secure the tow rope on the same side on both vehicles.
- ▶ Secure the tow rope to the towing eyes.
- ▶ Do not exceed the legally prescribed length of the tow rope.
- ▶ Mark the tow rope in the middle, e.g. with a white cloth (12 x 12 in (30 x 30 cm)). This will make other road users aware that a vehicle is being towed.
- ▶ During the journey, observe the brake lamps of the towing vehicle and main-

- ▶ maintain the distance so that the tow rope does not sag.
- ▶ Do not use steel cables or chains to tow your vehicle.

! **NOTE** Damage due to towing the vehicle at too high a speed or too far

Towing the vehicle at too high a speed or too far can damage the drivetrain.

- ▶ Do not exceed a towing speed of 31 mph (50 km/h).
- ▶ Do not exceed a towing distance of 31 miles (50 km).

! **NOTE** Damage to the automatic transmission when shifting into transmission position **P**

If you open the driver's or co-driver's door when towing, it can lead to the automatic

transmission shifting to position **P** and becoming damaged.



- ▶ Shift the automatic transmission to position **N**.
- ▶ Do not open any doors during the towing process.

When towing away, you must observe the legal requirements for the country in which you are currently driving.

In the event of a breakdown, Mercedes-Benz recommends that you have the vehicle transported instead of towed.

Have the vehicle transported on a transporter or trailer if it has transmission damage.

Permissible towing methods

			
	Both axles on the ground	Front axle raised	Rear axle raised
Vehicles with automatic transmission	Yes, no further than 31 miles (50 km) at 31 mph (50 km/h)	No	Yes, if the steering wheel is fixed in the center position with a steering wheel lock. Maximum 31 miles (50 km) at 31 mph (50 km/h)

i If the transmission cannot be shifted to position **N**, have the vehicle transported (→ page 199). A towing vehicle with lifting equipment is required for vehicle transport.

Towing away the vehicle with both axles on the ground

- ▶ Observe the notes on permissible towing methods (→ page 197).
- ▶ Make sure that the battery is connected and charged.

If the battery is discharged, observe the following points:

- The ignition cannot be switched on.
- The transmission cannot be shifted to position **N**.

Vehicles with automatic transmission

- ▶ Switch on the hazard warning lamps (→ page 78).
- ▶ Install the towing eye (→ page 200).
- ▶ Secure the towing device.
- ▶ Switch on the ignition.

- ▶ Deactivate automatic locking (→ page 46).
- ▶ Do not activate the HOLD function.
- ▶ Deactivate Active Brake Assist (→ page 115).
- ▶ Deactivate Active Distance Assist DISTRONIC (→ page 117, 119).
- ▶ Shift the transmission to position **N** (→ page 105).
- ▶ Release the parking brake (→ page 109).

Recovering a vehicle that is stuck

! **NOTE** Damage due to pulling force being too high

If you pull away abruptly, excessive pulling force could damage the vehicles.

- ▶ Pull away as straight, slowly and smoothly as possible.

If the drive wheels get trapped on loose or muddy ground, recover the vehicle with the utmost care, especially so if the vehicle is laden.

- ▶ Observe the notes on permissible towing methods (→ page 197).
- ▶ Never attempt to recover a vehicle that is stuck when a trailer is attached.
- ▶ If possible, pull the vehicle out backwards using the tracks it made before it became stuck.

Towing the vehicle with the axle raised

With the rear axle raised

- ▶ Observe the notes on permissible towing methods (→ page 197).
- ▶ Switch on the hazard warning lamps (→ page 78).
- ▶ Deactivate the tow-away alarm (→ page 60).
- ▶ Move the front wheels to the straight-ahead position.
- ▶ Fix the steering wheel in the center position with a steering wheel lock.
- ▶ Release the parking brake (→ page 109).
- ▶ Turn the key to position **0** in the ignition lock and remove the key from the ignition lock.
- ▶ Take the key with you when leaving the vehicle.

Do not exceed a towing speed of 31 mph (50 km/h).

Loading the vehicle for transport

! **NOTE** Damage due to incorrect attachment

The vehicle may be damaged when lashing to chassis components.

- ▶ Only lash the vehicle at the wheels.

- ▶ Observe the notes on permissible towing methods (→ page 197).
- ▶ To load the vehicle onto a trailer or transporter, use the trailer tow hitch or the towing eye.

Before loading the vehicle

- ▶ Switch on the ignition.
- ▶ Shift the transmission to position **N**.
- ▶ Release the parking brake (→ page 109).
- ▶ Load the vehicle onto the transporter.

! **NOTE** Damage to the drive train due to incorrect positioning of the vehicle

- ▶ Do not position the vehicle above the connection point of the transport vehicle.

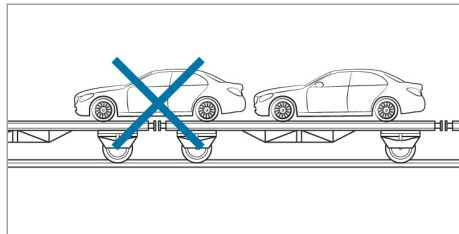

- ▶ Make sure that the front and rear axles come to rest on the same transportation vehicle.

After loading the vehicle

- ▶ Shift the transmission to position **P**.
- ▶ Disarm the tow-away alarm (→ page 60).
- ▶ Turn the key to position **0** in the ignition lock and remove it from the ignition lock.
- ▶ Use the parking brake to secure the vehicle against rolling away.
- ▶ Secure the vehicle by the wheels.

Towing eye storage location

The towing eye is located in the vehicle tool kit (→ page 201).

Installing/removing the towing eye

Installing and removing the front towing eye

! **NOTE** Damage to the vehicle due to incorrect use of the towing eye

When a towing eye is used to recover a vehicle, the vehicle may be damaged in the process.

- ▶ Only use the towing eye to tow away or tow start the vehicle.

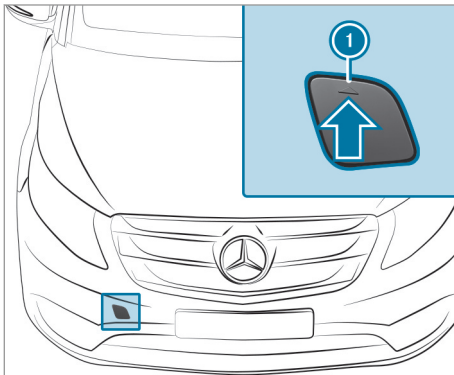

Fixture for the front towing eye in the bumper

- ▶ Take the towing eye and screwdriver from the vehicle tool kit (→ page 201).

Installing

- ▶ Press the arrow on cover ① and remove cover ① from the opening. You will see the fixture for the towing eye.
- ▶ Screw in the towing eye clockwise to the stop.
- ▶ Insert the screwdriver into the towing eye and tighten the towing eye.
- ▶ Stow the screwdriver in the vehicle tool kit.

Removing

- ▶ Remove the screwdriver from the vehicle tool kit.
- ▶ Insert the screwdriver into the towing eye and turn the towing eye counter-clockwise.

- ▶ Unscrew and remove the towing eye.
- ▶ Insert cover ① with the lug at the top and press it in at the bottom until it engages.
- ▶ Stow the towing eye and the screwdriver with the vehicle tool kit.

Rear towing eye

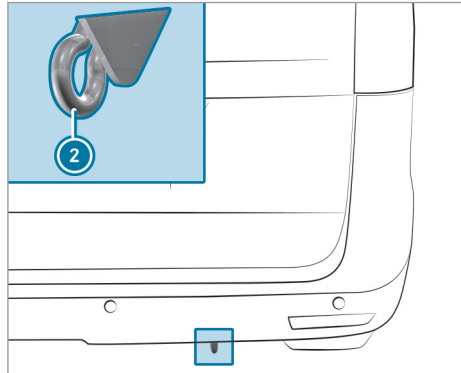

Rear towing eye under the bumper

- ▶ When towing or tow-starting a vehicle, attach the towing device to rear towing eye ②.
- ▶ If the vehicle is equipped with a trailer tow hitch, attach the towing device to the trailer tow hitch (→ page 233).
- ▶ Observe the notes on permissible towing methods (→ page 197).

Tow starting vehicle (emergency engine start)

! **NOTE** Damage to the automatic transmission due to tow starting

The automatic transmission may be damaged in the process of tow starting vehicles with automatic transmission.

- ▶ Vehicles with automatic transmission must not be tow started.

- ▶ Observe the notes and information on starting assistance (→ page 191).

Electrical fuses

Notes on electrical fuses

! NOTE Electrical fuses

- ▶ Observe the information in the supplement. You may otherwise fail to recognize dangers.

The fuse allocation chart and the information on the fuses can be found in the "Fuse allocation chart" Supplement.

Vehicle tool kit

Information on the vehicle tool kit

The vehicle tool kit storage location depends on the equipment version of the vehicle.

The following are examples of storage locations:

- In the seat base of the left front seat
- In the rear storage compartment
- In the tool holder in the cargo compartment

Apart from some country-specific variants, vehicles without a spare wheel are not equipped with a tire-changing tool.

If your vehicle is equipped with a tire-change tool kit, you can find it in the vehicle tool kit.

If the vehicle tool kit is stored in the driver's seat base, you can find the jack in a separate holder at the rear of the cargo compartment on the right-hand side (→ page 203).

Some tools for changing a wheel are specific to the vehicle. For more information on which tire-change tools are required and approved for performing a wheel change on your vehicle, consult a qualified specialist workshop.

Required tire-change tools may include the following, for example:

- Jack
- Lug wrench
- Ratchet wrench

- ⓘ The jack has a maximum weight of 16.5 lbs (7.5 kg) depending on the vehicle's equipment.

You will find the maximum load capacity of the jack stated on the adhesive label attached to the jack.

The jack is maintenance-free. If there is a malfunction, please contact a qualified specialist workshop.

Opening and closing the stowage compartment in the seat base

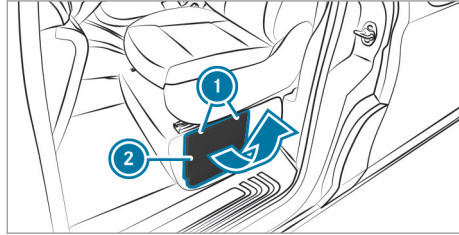

Storage compartment in the seat base of the left front seat

- ▶ **To open:** press catch springs ① down and release cover ② upwards from the seat base. Cover ② can be removed by pulling upwards at an angle from the seat base.

- ▶ Remove the clamping strap and remove the vehicle tool bag.

- ⓘ For vehicles with a tire-change tool kit, the jack is in a separate holder in the rear right-hand side of the cargo compartment (→ page 203).

- ▶ **To close:** after stowing the vehicle tool bag, insert cover ② below in the seat base and fold shut. Catch springs ① of cover ② should engage audibly.

Storage compartment in the rear compartment

Opening the storage compartment

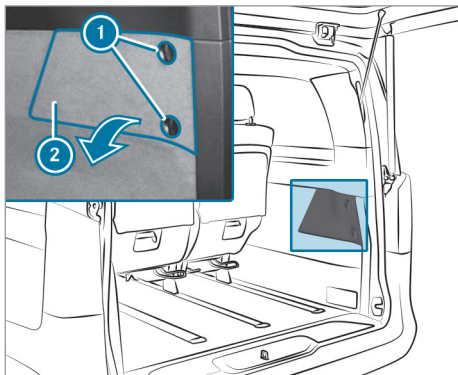

Storage compartment in the rear compartment on the right-hand side of the vehicle

- ▶ If necessary, fold up the rear seat.
- ▶ Turn top rotary catch ① clockwise and bottom rotary catch ② counter-clockwise.
- ▶ Remove cover ③.

Removing the vehicle tool kit and jack from the tool holder

Depending on the equipment version of the vehicle, the vehicle tool kit and the jack are stored either in a storage tray or in a tool holder with a cover.

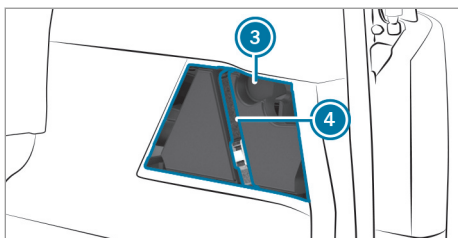

Storage compartment with tool holder

- ▶ Remove clamping strap ④.
- ▶ Lift off tool holder cover ③.
- ▶ Carefully pull the vehicle tool kit and jack upwards out of the storage compartment. Lift the jack slightly before removing it and turn it to a diagonal position in the storage compartment.

Removing the vehicle tool kit and jack from the storage tray

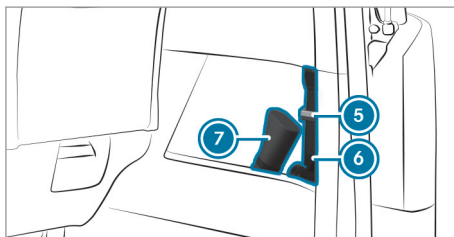

Storage compartment with storage tray

- ▶ Open clamping strap ⑤ and remove jack ⑥ by pulling it upwards at an angle from the storage tray compartment.
- ▶ Remove vehicle tool bag ⑦ upwards from the storage tray compartment.

Stowing the vehicle tool kit and the jack Storage compartment with tool holder

- ▶ Before storing, wind the jack to the fully closed position and place it so that the hand wheel is facing forwards and the plate is facing inwards.
- ▶ Place the jack and vehicle tool kit into the tool holder.
- ▶ Replace cover ③ of the tool holder.
- ▶ Tighten clamping strap ④.

Storage compartment with storage tray

- ▶ Insert vehicle tool bag ⑦ into the front compartment of the storage tray.
- ▶ Before storing, wind jack ⑥ to the fully closed position and place it so that the hand wheel is facing downwards and the plate is facing inwards at an angle.
- ▶ Insert jack ⑥ into the back compartment of the storage tray.
- ▶ Press jack ⑥ into the upper holder and fasten clamping strap ⑤. The jack is secured.

Closing the storage compartment

- ▶ Put on cover ②.
- ▶ Turn top rotary catch ① counter-clockwise and bottom rotary catch ② clockwise.
- ▶ Fold down the rear seat.

Tool holder in the cargo compartment

Removing the tool and the jack

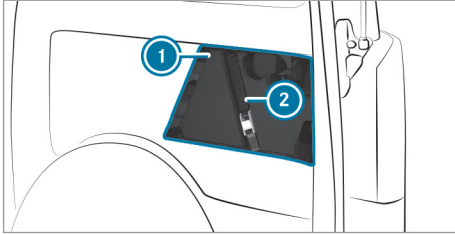

Tool holder in the cargo compartment on the right-hand side of the vehicle (example: Cargo Van)

- ▶ Remove clamping strap ②.
- ▶ Remove cover ① of the tool holder.
- ▶ Carefully pull the vehicle tool kit and jack out of the tool holder.

Storing the tool and the jack

- ▶ Before storing, wind the jack to the fully closed position and place it so that the handwheel is facing forwards and the plate is facing inwards.
- ▶ Place the jack and vehicle tool kit into the tool holder.
- ▶ Fit the cover ① of the tool holder.
- ▶ Tighten clamping strap ②.

Removing the jack from the tool holder

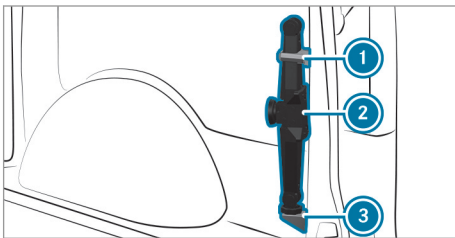

Holder for jack in the cargo compartment on the right-hand side of the vehicle (for example, Cargo Van)

- ▶ Remove clamping strap ①.
- ▶ Pull jack ② out of the upper holder and from lower bracket ③.
- ▶ The vehicle tool bag or tire-change tool kit is in the seat base of the left front seat (→ page 201).

Stowing the jack

- ▶ Before stowing, wind the jack as far as it will go and position it with the handwheel facing down and the plate facing inwards.
- ▶ Place jack ② onto lower bracket ③.
- ▶ Press jack ② into the upper holder and fasten clamping strap ①.
The jack is secured.

Information on noise or unusual driving characteristics

While driving, pay attention to vibrations, noises and unusual driving characteristics, e.g. pulling to one side. This may indicate damage to the wheels or tires. If you suspect that a tire is defective, reduce your speed. Stop the vehicle as soon as possible to check if wheels and tires have been damaged or are no longer functioning properly. Hidden tire damage could also be causing the unusual driving characteristics. If no signs of damage can be detected, have the tires and wheels checked at a qualified specialist workshop.

Notes on regularly inspecting wheels and tires

⚠ WARNING Risk of accident from damaged tires

Damaged tires can cause tire pressure loss. As a result, you could lose control of your vehicle.

▶ Check the tires regularly for signs of damage and replace any damaged tires immediately.

Check the wheels and tires of your vehicle for damage regularly, i.e. at least every two weeks, as well as after driving off-road or on rough roads. Damaged wheels can lead to a loss of tire pressure.

Look out for the following types of damage, for example:

- Cuts in the tires
- Punctures in the tires
- Tears in the tires
- Bulges on tires
- Deformation or severe corrosion on wheels

⚠ WARNING Risk of hydroplaning because tire tread is too low

Insufficient tire tread will result in reduced tire traction. The tire tread will no longer be able to dissipate water.

This increases the risk of hydroplaning on wet road surfaces, particularly when traveling at an inappropriate speed.

If the tire pressure is too high or too low, tires may exhibit different levels of wear at different locations on the tire tread.

▶ Regularly check the tire tread depth and the condition of the tire tread across the entire width of all tires.

Minimum tread depth for use:

- In summer: $\frac{1}{8}$ in (3 mm)
- In winter: $\frac{1}{4}$ in (4 mm)

▶ For safety reasons, have the tires replaced before the legally prescribed limit for the minimum tire tread depth is reached.

Conduct the following checks regularly on all wheels, at least once a month or as required, e.g. before a long journey or when driving off-road:

- Check the tire pressure (→ page 206)
- Check the valve caps

Valves must be protected from moisture and dirt with valve caps specifically approved by Mercedes-Benz for your vehicle.

- Visually inspect the tread depth and the tire tread across the whole tire width

For use in summer, the minimum tread depth is $\frac{1}{8}$ in (3 mm) and for use in winter $\frac{1}{4}$ in (4 mm).

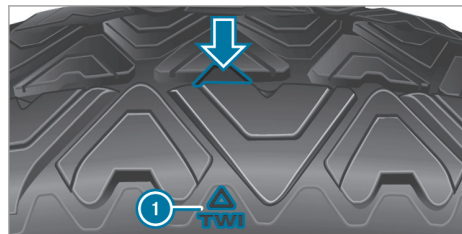

Markings ① show in which places the bar indicators (arrow) are integrated into the tire tread. They are visible as soon as the tread depth is approximately $\frac{1}{16}$ in (1.6 mm).

Information on driving with summer tires

At temperatures below 50 °F (10 °C) Summer tires lose elasticity and therefore traction and braking power. Change the tires on your vehicle to M+S tires. Using summer tires at very cold temperatures could cause tears to form, thereby damaging the tires permanently. Mercedes-Benz

cannot accept responsibility for this type of damage.

Always observe the maximum permissible speed specified for the summer tires you have installed (→ page 213).

Once you have installed the summer tires:

- Check the tire pressure (→ page 206)
- Restart the tire pressure monitor (→ page 209)

Information on M+S tires

⚠ WARNING Risk of accident caused by incorrect wheel and tire dimensions

The wheel or tire size and the tire type of the emergency spare wheel or spare wheel and the wheel to be replaced may differ.

To prevent hazardous situations:

- ▶ Adapt your driving style accordingly and drive carefully.
- ▶ Never install more than one emergency spare wheel or spare wheel that differs in size.
- ▶ Only use an emergency spare wheel or spare wheel of a different size briefly.
- ▶ Have the emergency spare wheel or spare wheel of a different size replaced at the nearest qualified specialist workshop. The new wheel must have the correct dimensions.

⚠ WARNING Risk of an accident due to insufficient tire tread

M+S tires with a tread depth of less than $\frac{1}{16}$ in (4 mm) are not suitable for use in winter and do not provide sufficient grip.

- ▶ M+S tires with a tread depth of less than $\frac{1}{16}$ in (4 mm) must be replaced immediately.

At temperatures below 50 °F (10 °C) use winter tires or all-season tires – both are marked with M+S.

Only winter tires bearing the  snowflake symbol in addition to the M+S marking provide the best possible grip in wintry road conditions.

Only these tires will allow driving safety systems such as ABS and ESP® to also function optimally

in winter. These tires have been developed specifically for driving in snow.

Use M+S tires of the same make and tread on all wheels to maintain safe handling characteristics.

Always observe the maximum permissible speed specified for the M+S tires you have installed (→ page 213).

If you install M+S tires that have a lower maximum permissible speed than the maximum design speed of the vehicle, affix an appropriate warning sign in the driver's field of vision. You can obtain this at a qualified specialist workshop.

Once you have installed the winter tires, take the following measures:

- check the tire pressure (→ page 206)
- restart the tire pressure monitor (→ page 209)

Notes on snow chains

⚠ WARNING Risk of accident due to incorrectly installed snow chains

If you have installed snow chains on the front wheels, they may drag against the vehicle body or chassis components.

- ▶ Never install snow chains on the front wheels.
- ▶ Only install snow chains on the rear wheels in pairs.

⚠ WARNING Risk of accident due to unsuitable snow chains

Commercially available snow chains can come loose and damage chassis components or brake hoses.

- ▶ Only install snow chains that have been approved by Mercedes-Benz for these tires.

⚠ WARNING Risk of accident due to snow chains breaking

If you drive too fast with snow chains, they can break, injure other persons, and damage the vehicle.

- ▶ Observe the maximum permissible speed for operation with snow chains.

I NOTE Damage to the wheel trim from mounted snow chains

If snow chains are mounted to steel wheels, the wheel trims can be damaged.

- ▶ Remove the wheel trims of steel wheels before mounting snow chains.

Observe the following notes when using snow chains:

- Snow chains are only permissible for certain wheel/tire combinations. You can obtain information on them at a qualified specialist workshop.
- For safety reasons, only use snow chains that have been specifically approved for your vehicle by Mercedes-Benz, or snow chains with the same quality standard.
- The snow chains must be retightened after driving approximately 0.6 miles (1 km). This is the only way to ensure the snow chains are optimally seated with clearance to adjacent components.
- **Vehicles with rear-wheel drive:** only install snow chains in pairs and only on the rear wheels. Observe the manufacturer's installation instructions.
- **Vehicles with front-wheel drive:** only install snow chains in pairs and only on the front wheels. Observe the manufacturer's installation instructions.
- Use snow chains only when the road surface is completely snow-covered. Remove the snow chains as soon as possible when you come to a road that is not snow-covered.
- Local regulations may restrict the use of snow chains. Observe the applicable regulations before installing snow chains.
- If snow chains are installed, the maximum permissible speed is 30 mph (50 km/h).

i You can deactivate ESP® to pull away (→ page 111, 112). This allows the wheels to spin, achieving an increased driving force.

Tire pressure

Notes on tire pressure

⚠ WARNING Risk of accident due to insufficient or excessive tire pressure

Tires with either too low or too high a pressure present the following hazards:

- the tires could burst
- the tires could wear excessively and/or unevenly
- the driving characteristics as well as steering and braking characteristics may be severely impaired

▶ Observe the recommended tire pressures and check the tire pressure of all tires including the spare wheel:

- monthly
- if altering the load on the vehicle
- prior to long journeys
- if the operating conditions change, for example when driving off-road

▶ Adjust the tire pressure where necessary.

Driving with tire pressure that is too high or too low can:

- Shorten the service life of the tires
- Cause increased tire damage
- Adversely affect handling characteristics and thus driving safety, e.g. due to hydroplaning

⚠ WARNING Risk of accident due to too low a tire pressure

Tires with pressure that is too low can overheat and burst as a consequence.

In addition, they also suffer from irregular wear, which can significantly impair the braking properties and the handling characteristics.

▶ Avoid excessively low tire pressure.

Tire pressure which is too low can cause:

- Tire malfunctioning as a result of overheating
- Impaired handling characteristics
- Irregular wear
- Increased fuel consumption

⚠ WARNING Risk of accident due to too high a tire pressure

Tires with excessively high pressure can burst.

In addition, they also suffer from irregular wear, which can significantly impair the braking properties and the handling characteristics.

- ▶ Avoid excessively high tire pressures.

Excessively high tire pressure can result in:

- Increased braking distance
- Impaired handling characteristics
- Irregular wear
- Impaired driving comfort
- Susceptibility to damage

⚠ WARNING Risk of accident due to repeated pressure drop in the tires

The wheels, valves or tires could be damaged. Too low a tire pressure can lead to the tires bursting.

- ▶ Examine the tires for foreign objects.
- ▶ Check whether the tire has a puncture or the valve has a leak.
- ▶ If you are unable to rectify the damage, contact a qualified specialist workshop.

You can find information on recommended tire pressures for the vehicle's factory-installed tires on the following labels:

- Tire and Loading Information placard on the B-pillar of your vehicle .
- Tire pressure table on the inside of the fuel filler flap .

Observe the maximum tire pressure (→ page 213).

Use a suitable pressure gauge to check the tire pressure. The outer appearance of a tire does not permit any reliable conclusion about the tire pressure.

🔥 ENVIRONMENTAL NOTE Environmental damage due to insufficient or excessive tire pressure

Insufficient or excessive tire pressure shortens the service life of the tires.

- ▶ Check the tire pressure regularly, but at least every 14 days.

Vehicles with a tire pressure monitor: you can also check the tire pressure using the on-board computer.

Only correct tire pressure when the tires are cold. Conditions for cold tires:

- The vehicle has been parked with the tires out of direct sunlight for at least three hours.
- The vehicle has traveled less than 1 mile (1.6 km).

A rise in the tire temperature of 18 °F (10 °C) increases the tire pressure by approx. 10 kPa (0.1 bar/1.5 psi). Take this into account when checking the tire pressure of warm tires.

The tire pressure recommended for increased load/speed in the tire pressure table may affect the ride comfort.

⚠ WARNING Risk of accident due to unsuitable accessories on tire valves

If you mount unsuitable accessories onto tire valves, the tire valves may be overloaded and malfunction, which can cause tire pressure loss.

- ▶ Only screw standard valve caps or valve caps specifically approved by Mercedes-Benz for your vehicle onto the tire valve.

Notes on trailer operation

The applicable tire pressure for the tires of the rear axle is always the recommended tire pressure for a full load.

Overview of the tire pressure table

PRESSURE		COLD TIRES			
Warm tires up to					
+ 30 kPa + 4 psi		kPa		psi	
195/65 R16 C					
104T / 100T					
205/65 R16 C					
103H / I					
245/45 R19 XL					
102Y					

* XL=Extra large=RF=Reinforced
100 kPa = 1 bar XXXXXXXXXXXX 1234567

Additionally, the tire pressure table may also state tire pressures for different load conditions. These are defined in the tire pressure information table as different numbers of passengers and amounts of luggage. The actual number of seats may differ – for more information, please refer to the vehicle's registration documents.

The tire pressure values given for partly laden vehicles are minimum values which offer you good ride comfort. They are not for trailer operation.

You can also use the tire pressure values for a fully laden vehicle. These are always allowed and permissible. However, in a partially laden vehicle, the ride is not as comfortable and fuel consumption is only minimally reduced. In addition, wear is greater in the middle of the tire tread.

For trailer operation, the applicable value for the rear tires is the maximum tire pressure value stated in the tire pressure table inside the fuel filler flap.

Use a suitable pressure gauge to check the tire pressure. The outer appearance of a tire does not permit any reliable conclusion about the tire pressure.

On vehicles installed with the electronic tire pressure monitor, the tire pressure can be checked using the on-board computer.

Set the correct tire pressure before loading the vehicle. Once the vehicle is laden, check the tire pressures and correct them if necessary.

Only correct tire pressure when the tires are cold. The tires are cold under the following conditions:

- The vehicle has been parked with the tires out of direct sunlight for at least three hours.
- The vehicle has traveled less than 1 mile (1.6 km).

A rise in the tire temperature of 18 °F (10 °C) increases the tire pressure by approx. 10 kPa (0.1 bar/1.5 psi). Take this into account when checking the tire pressure of warm tires.

Driving with tire pressure that is too high or too low can:

- shorten the service life of the tires
- cause increased tire damage
- have a negative effect on handling characteristics and thus driving safety (e.g. due to hydroplaning)

Vehicles with a gross vehicle weight of 6,614 lbs (3,000 kg)

The following tire pressure values apply to the following vehicles:

- With a gross vehicle weight of 6,614 lbs (3,000 kg)
- With a gross axle weight rating of 3,307 lbs (1,500 kg) on the rear axle
- The tires referred to under "Wheel and tire combinations" (→ page 221)

The tire pressure for the spare wheel is 350 kPa (3.5 bar/51 psi).

Tires/disc wheel	Partially laden vehicle		Fully laden vehicle	
	Front axle	Rear axle	Front axle	Rear axle
225/55 R 17 XL	280 kPa (2.8 bar/41 psi)	270 kPa (2.7 bar/39 psi)	310 kPa (3.1 bar/45 psi)	310 kPa (3.1 bar/45 psi)

Tire pressure monitoring system

Function of the tire pressure monitoring system



The system checks the tire pressure and the tire temperature of the tires installed on the vehicle by means of a tire pressure sensor.

New tire pressure sensors, e.g. in winter tires, are automatically taught-in during the first journey they are used.

It is the driver's responsibility to set the tire pressure to the recommended cold tire pressure suitable for the operating situation (→ page 206).

Note that the correct tire pressure for the current operating situation must first be taught-in to the tire pressure monitoring system. If a substantial loss of pressure occurs, the warning threshold for the warning message is aligned to the taught-in reference values. Restart the tire pressure monitor after adjusting to the cold tire pressure (→ page 209). The current pressures are saved as new reference values. This will ensure that a warning message will only appear if the tire pressure drops significantly.

The  warning lamp in the instrument cluster displays a detected pressure loss or a malfunction as follows:

- If the  warning lamp is lit continuously, the tire pressure on one or more tires is significantly too low. The tire pressure monitor is not malfunctioning.
- If the  warning lamp flashes for around a minute and then remains lit constantly, the tire pressure monitor is malfunctioning.
- A message also appears in the instrument cluster.

System limits

The system may be impaired or may not function in the following situations:

- The tire pressure has been set incorrectly.
- There is a sudden pressure loss caused, for example, by a foreign object penetrating the tire.
- There is a malfunction caused by another radio signal source.

If the tire pressure monitor is malfunctioning, it may take more than ten minutes for the  tire pressure warning lamp to inform you of the malfunction. When the malfunction has been recti-

fied, the  warning lamp goes out after you have driven for a few minutes.

The tire pressure value indicated by the on-board computer may differ from those measured at a gas station using a pressure gauge.





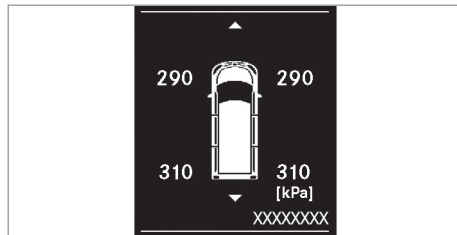

The tire pressures shown by the on-board computer refer to those measured at sea level. At high altitudes, the tire pressure value indicated by a pressure gauge are higher than those shown by the on-board computer. In this case, do not reduce the tire pressure.

Checking the tire pressure electronically (only vehicles with steering wheel buttons)

Requirements:

- The ignition is switched on.



- ▶ Press the  or  button to select **Service**.
- ▶ Press the  button.
- ▶ Press the  or  button to select **Tire Pressure**.
- ▶ Press the  button. The display shows the current tire pressure of each wheel.

If the vehicle was parked for longer than 20 minutes, the **Tire pressure will be displayed after driving a few minutes** message appears in the display.

Make sure to observe the following further related subject:

- Notes on tire pressure (→ page 206)

Restarting the tire pressure monitor

Requirements:

- The ignition is switched on.
- The recommended tire pressure is correctly set for the respective operating condition on each of the four wheels (→ page 207).

Vehicles with steering-wheel buttons



- ▶ Use the ◀ or ▶ button to select **Service**.
- ▶ Use the ▼ or ▲ button to select **Tire Pressure**.
- ▶ Press the OK button to confirm. The display shows the current tire pressures of each wheel or the **Tire pressure will be displayed after driving a few minutes** message.
- ▶ Press the ▾ button. The **Use Current Pressures as New Reference Values** message is shown in the display.
- ▶ **To confirm restart:** press the OK button. The **Tire Press. Monitor Restarted** message is shown in the display. After you have driven for a few minutes, the system checks whether the current tire pressures are within the specified range. The new tire pressures are then accepted as reference values and monitored.
- ▶ **To cancel restart:** press the ⏪ button. The tire pressure values stored at the last restart will continue to be monitored.



Vehicles without steering-wheel buttons

The vehicle must be at a standstill. Use the buttons on the instrument cluster.

- ▶ Press the Ⓜ button to select the **Tire Pressure** menu.
- ▶ Press the Ⓡ button to confirm. The **Monitoring Active** message is shown in the display.
- ▶ Press the Ⓡ button to confirm. The **Tire Pressure OK?** message is shown in the display.
- ▶ **To confirm restart:** press the ⊕ button. The display shows the **Distance** menu. After you have driven for a few minutes, the system checks whether the current tire pressures are within the specified range. The new tire pressures are then accepted as reference values and monitored.
- ▶ **To cancel restart:** press the ⊖ button. The display shows the **Tire Pressure** menu. The tire pressure values stored at the last restart will continue to be monitored.

Radio equipment approval of the tire pressure monitoring system**Radio equipment approval numbers**

Country	Radio equipment approval number
Argentina	 CNC: H-12336 Model: Schrader HSW4
Brazil	 MODELO: GG4 ANATEL: 0381-13-8001 Este equipamento opera em caráter secundário, isto é, não tem direito à proteção contra interferência prejudicial, mesmo de estações do mesmo tipo e não pode causar interferência a sistemas operando em caráter primário.
Jordan	Kingdom of Jordan Type approval for Tyre Pressure Sensor and ECU Manufacturer: Schrader Electronics Ltd. Model: Mercedes HS Snap in 433 MHz Type Approval Number: TRC/LPD/2013/48 Type Approval Number: LPD
Morocco	AGREE PAR L'ANRT MAROC MR7907 ANRT 2013 Date d'agrement: 05/03/2013
Moldova	 1024

Country	Radio equipment approval number
Philippines	 NTC Type Approved. No: ESD-1306995C
Singapore	Complies with IDA Standards DA-103365
South Africa	 TA-2013/461
United Arab Emirates Abu Dhabi and Dubai	TRA Registered No: ER0104996/13 Dealer No: DA0047074/10

Tire labeling

Overview of tire labeling

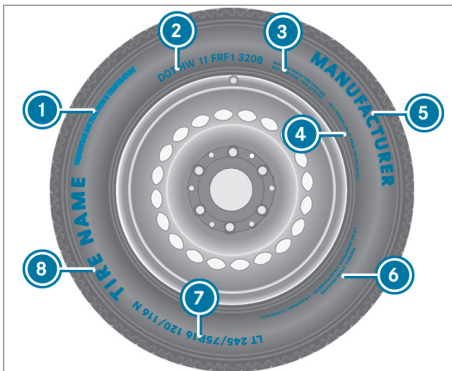

- ① Uniform Tire Quality Grading Standards (→ page 211)
- ② DOT (Department of Transportation), (TIN) Tire Identification Number (→ page 212)
- ③ Maximum tire load (→ page 213)
- ④ Maximum tire pressure (→ page 213)
- ⑤ Manufacturer
- ⑥ Characteristics of the tire (→ page 213)

- ⑦ Tire size designation, load-bearing capacity, speed rating and load index (→ page 213)
 - ⑧ Tire name
- ① The data shown in the illustration is sample data.

Information on tire quality grades

According to the requirements of the U.S. Department of Transportation's "Uniform Tire Quality Grading Standards" tire manufacturers must grade their tires using the following three performance factors:

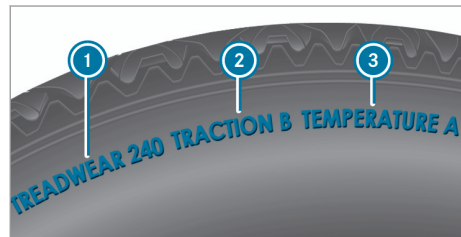

- ① Tread wear grade
 - ② Traction grade
 - ③ Temperature grade
- ① The data shown in the illustration is sample data.
- ① This grading is not legally prescribed for Canada, but specified in most cases anyway.

Tread wear grade

The tread wear grade is a comparative grading based on tread wear grade tests conducted under controlled conditions on a specified U.S. Department of Transportation test track. For example, a tire graded 150 would wear one and one-half times as well on the government test track as a tire graded 100.

The relative performance of tires depends upon the actual conditions of their use, however, and may depart significantly from the norm due to variations in driving habits, service practices and differences in road characteristics and climate conditions.

Traction grade

⚠ DANGER Risk of accident due to inadequate traction

The traction grade assigned to this tire is based on straight-ahead braking traction tests, and does not include either acceleration, cornering, hydroplaning or peak traction characteristics.

- ▶ Always adapt your driving style and drive at a speed to suit the prevailing traffic and weather conditions.

! NOTE Damage to the drivetrain from wheelspin

- ▶ Avoid wheelspin.

The traction grades – from highest to lowest – are AA, A, B and C. These grades relate to the tire's ability to come to a standstill on a wet pavement under controlled conditions on a specified U.S. government test surface made from asphalt and concrete.

Temperature grade

⚠ WARNING Risk of accident from tire overheating and tire failure

The temperature grade for this tire is established for a tire that is properly inflated and not overloaded. Excessive speed, underinflation, or excessive loading, either separately or in combination, can cause excessive heat build-up and possible tire failure.

- ▶ Observe the recommended tire pressures and regularly check the tire pressure of all tires including the spare wheel.
- ▶ Adjust the tire pressure as necessary.

The temperature grades are A (highest grade), B and C. These relate to a tire's resistance to heat and its ability to release heat on a specified test wheel in laboratory tests under controlled conditions. Sustained high temperatures can cause the material of the tire to degenerate and reduce tire life. In addition, excessively high temperatures can lead to sudden tire failure. Grade C refers to a performance which all passenger vehicle tires must exhibit, according to the U.S. Department of Transportation's requirements.

Information on DOT and TIN (Tire Identification Number)

U.S. tire regulations indicate that every tire manufacturer or retreader must imprint a TIN in or on the sidewall of each tire produced.

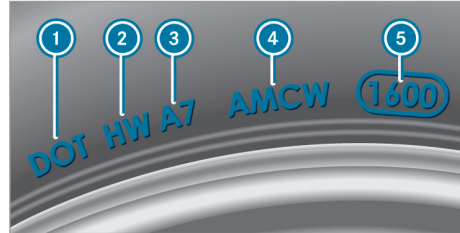

i The data shown in the illustration is sample data.

The TIN is a unique identification number for tires and consists of the following components:

- **DOT (Department of Transportation):** tire symbol **1** indicates that the tire complies with the requirements of the U.S. Department of Transportation.
- **Manufacturer identification code:** manufacturer identification code **2** provides information about the tire manufacturer. New tires have a code with two symbols. Retreaded tires have a code with four symbols. For further information about retreaded tires, see (→ page 216).
- **Tire size:** identifier **3** describes the tire size.
- **Tire type code:** tire type code **4** can be used by the manufacturer as a code to describe specific characteristics of the tire.
- **Date of manufacture:** date of manufacture **5** provides information about the age of a tire. The 1st and 2nd numbers indicate the calendar week and the 3rd and 4th numbers indicate the year of manufacture (e.g. "3208" refers to the 32nd week of the year 2008).

Information on maximum tire load



i The data shown in the illustration is sample data.

Maximum tire load **1** is the maximum permissible weight for which the tire is approved.

Do not overload the tires by exceeding the maximum permissible load. The maximum permissible load can be found on the vehicle's Tire and Loading Information placard on the B-pillar on the driver's side .

Information on maximum tire pressure

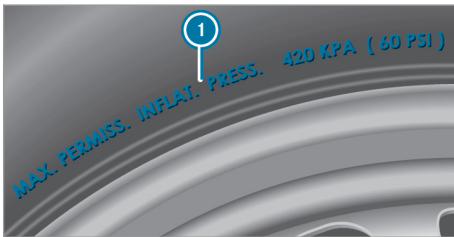

i The data shown in the illustration is sample data.

Maximum permitted tire pressure **1** must never be exceeded. Always observe the recommended tire pressure for your vehicle when adjusting the tire pressure (→ page 207).

Information on tire characteristics



i The data shown in the illustration is sample data.

This information describes the type of tire cord and the number of layers in sidewall **1** and under tire tread **2**.

Tire size designation, load-bearing capacity, speed rating and load index

⚠ WARNING Risk of injury through exceeding the specified tire load-bearing capacity or the permissible speed rating

Exceeding the specified tire load rating or the permissible speed rating may lead to tire damage and to the tires bursting.

- ▶ Therefore, only use tire types and sizes approved for your vehicle model.
- ▶ Observe the tire load rating and speed rating required for your vehicle.

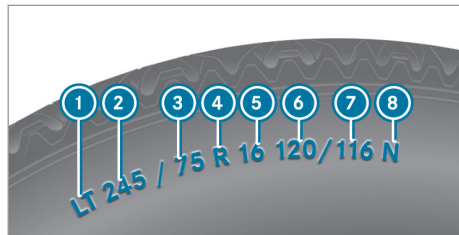

- 1** First letter(s)
- 2** Nominal tire width in millimeters
- 3** Aspect ratio (in percent)
- 4** Tire code
- 5** Rim diameter
- 6** Load-bearing index
- 7** Load index
- 8** Speed rating

i The data shown in the illustration is sample data.

Further information about reading tire data can be obtained from any qualified specialist workshop.

First letter(s) **1**:

- "LT": light truck tires in accordance with US manufacturer standards.
- "C": tires for commercial usage in accordance with European manufacturer standards.

Aspect ratio (in percent) ③:

The size ratio between the tire height and tire width and is shown in percent (tire height divided by tire width).

Tire code ④ (tire type):

- "R": radial tire

Rim diameter ⑤:

The diameter of the bead seat (not the diameter of the rim flange). The rim diameter is specified in inches (in).

Load-bearing index ⑥:

Numerical code which specifies the maximum load-bearing capacity of a tire ("91" equals, e.g. 1,356 lb (615 kg)).

The tire load-bearing capacity must be at least half the gross axle weight rating of the vehicle. Do not overload the tires by exceeding the maximum permissible load.

See also:

- Maximum permissible load on the Tire and Loading Information placard
- Maximum tire load (→ page 213)
- Load index

Speed rating ⑧:

Specifies the approved maximum speed of the tire.

- ① An electronic speed limiter prevents your vehicle from exceeding a speed of 130 mph (210 km/h).

Ensure that your tires have the required speed rating. You can obtain information on the required speed rating at a Mercedes-Benz Commercial Van Center.

Summer tires

Index	Speed rating
L	Up to 75 mph (120 km/h)
M	Up to 81 mph (130 km/h)
N	Up to 87 mph (140 km/h)
P	Up to 93 mph (150 km/h)
Q	Up to 100 mph (160 km/h)
R	Up to 106 mph (170 km/h)

Summer, all-season and winter tires

Index	Speed rating
L M+S ¹	Up to 75 mph (120 km/h)
M M+S ¹	Up to 81 mph (130 km/h)
N M+S ¹	Up to 87 mph (140 km/h)
P M+S ¹	Up to 93 mph (150 km/h)
Q M+S ¹	Up to 100 mph (160 km/h)
R M+S ¹	Up to 118 mph (170 km/h)

¹: or "M+S"  " for winter tires.

Winter tires are marked with the  snowflake symbol and fulfill the requirements of the Rubber Manufacturers Association (RMA) and the Rubber Association of Canada (RAC) regarding the tire traction on snow.

Load index ⑦:

- "Light load": light load tire
- "C": commercial tires

Information on definitions (tires and loading)

Tire structure and characteristics: describes the number of layers or the number of rubber-coated layers in the tire tread and the tire wall. These are made of steel, nylon, polyester and other materials.

Bar: metric unit for tire pressure. 14.5038 pounds per square inch (psi) and 100 kilopascals (kPa) are the equivalent of 1 bar.

DOT (Department of Transportation): DOT marked tires fulfill the requirements of the U.S. Department of Transportation.

Average weight of vehicle occupants: the number of occupants for which the vehicle is designed multiplied by 150 lbs (68 kg).

Uniform Tire Quality Grading Standards: a uniform standard to grade the quality of tires with regards to tread quality, tire traction and temperature characteristics. The quality grading assessment is made by the manufacturer in accordance with test specifications of the U.S. government. The quality grade of a tire is imprinted on the sidewall of the tire.

Recommended tire pressure: the recommended tire pressure is the pressure specified for the tires installed on the vehicle at the factory.

The Tire and Loading Information placard contains the recommended tire pressures for cold tires, the maximum permissible load and the maximum permissible vehicle speed.

The tire pressure table contains the recommended tire pressures for cold tires under various operating conditions, i.e. load and/or speed of the vehicle.

Increased vehicle weight due to optional equipment: the combined weight of all standard and optional equipment available for the vehicle, regardless of whether it is actually installed on the vehicle or not.

Rim: the part of the wheel on which the tire is installed.

GAWR (Gross Axle Weight Rating): GAWR is the gross axle weight rating. The actual load on an axle must never exceed the Gross Axle Weight Rating. You can find the Gross Axle Weight Rating on the B-pillar on the driver's side.

Speed rating: the speed rating is part of the tire identification. It specifies the speed range for which a tire is approved.

GVW (Gross Vehicle Weight): the Gross Vehicle Weight includes the weight of the vehicle including fuel, tools, the spare wheel, accessories installed, occupants, luggage and the trailer drawbar noseweight if applicable. The Gross Vehicle Weight must never exceed the Gross Vehicle Weight Rating (GVWR) specified on the B-pillar on the driver's side.

GVWR (Gross Vehicle Weight Rating): the GVWR is the maximum permitted gross weight of the fully laden vehicle (weight of the vehicle including all accessories, occupants, fuel, luggage and the trailer drawbar noseweight if applicable). The Gross Vehicle Weight Rating is specified on the vehicle identification plate on the B-pillar on the driver's side.

Maximum weight of the laden vehicle: the maximum weight is the sum of the vehicle's curb weight, weight of the accessories, maximum load and the weight of the factory installed optional equipment.

Kilopascal (kPa): metric unit for tire pressure. 6.9 kPa are the equivalent of 1 psi. Another unit for tire pressure is bar. 100 kilopascals (kPa) are the equivalent of 1 bar.

Load index: in addition to the load-bearing index, the load index may also be imprinted on the sidewall of the tire. This specifies the load-bearing capacity more precisely.

Curb weight: the weight of a vehicle with standard equipment including the maximum capacity of fuel, oil and coolant. It also includes the air-conditioning system and optional equipment if these are installed on the vehicle, but does not include passengers or luggage.

Maximum tire load: the maximum tire load is the maximum permissible weight in kilograms or lbs for which a tire is approved.

Maximum permissible tire pressure: maximum permissible tire pressure for one tire.

Maximum load on one tire: maximum load on one tire. This is calculated by dividing the maximum axle load for one axle by two.

PSI (pounds per square inch): standard unit of measurement for tire pressure.

Aspect ratio: relationship between tire height and tire width in percent.

Tire pressure: pressure inside the tire applying an outward force to every square inch of the tire's surface. The tire pressure is specified in pounds per square inch (psi), in kilopascal (kPa) or in bar. The tire pressure should only be corrected when the tires are cold.

Tire pressure on cold tires: the tires are cold when the vehicle has been parked with the tires out of direct sunlight for at least three hours and the vehicle has been driven less than 1 mile (1.6 km).

Tire contact surface: the part of the tire that comes into contact with the road.

Tire bead: the purpose of the tire bead is to ensure that the tire sits securely on the wheel rim. There are several wire cores in the tire bead to prevent the tire from changing length on the wheel rim.

Side wall: the part of the tire between the tread and the tire bead.

Special equipment weight: the combined weight of those optional extras that weigh more than the replaced standard parts and more than 5 lbs (2.3 kg). These optional extras, such as high-performance brakes, level control system, a roof luggage rack or a high-performance battery, are not included in the curb weight and the weight of the accessories.

TIN (Tire Identification Number): a unique identification number which can be used by a tire manufacturer to identify tires, for example for a product recall, and thus identify the purchasers. The TIN is made up of the manufacturer identifi-

cation code, tire size, tire type code and the manufacturing date.

Load-bearing index: the load-bearing index (also load index) is a code that contains the maximum load-bearing capacity of a tire.

Traction: traction is the result of friction between the tires and the road surface.

Wear indicator: narrow bars (tread wear bars) that are distributed over the tire tread. If the tire tread is level with the bars, the wear limit of 1/16 in (1.6 mm) has been reached.

Distribution of vehicle occupants: distribution of vehicle occupants over designated seat positions in a vehicle.

Maximum permissible payload weight: nominal load and luggage load plus 150 lbs (68 kg) multiplied by the number of seats in the vehicle.

Changing a wheel

Notes on selecting, installing and replacing tires

You can ask for information regarding permitted wheel/tire combinations at a qualified specialist workshop.

⚠ WARNING Risk of injury through incorrect sizes of wheels and tires

If wheels and tires of the wrong size are installed, the wheel brakes or components in the brake system and in the wheel suspension may be damaged.

- ▶ Always replace wheels and tires with those that fulfill the specifications of the original part.

For wheels, pay attention to the following:

- Designation
- Type

For tires, pay attention to the following:

- Designation
- Manufacturer
- Type

⚠ WARNING Risk of injury through exceeding the specified tire load-bearing capacity or the permissible speed rating

Exceeding the specified tire load rating or the permissible speed rating may lead to tire damage and to the tires bursting.

- ▶ Therefore, only use tire types and sizes approved for your vehicle model.
- ▶ Observe the tire load rating and speed rating required for your vehicle.

! NOTE Vehicle and tire damage through tire types and sizes that have not been approved

For safety reasons, only use tires, wheels and accessories which have been specially approved by Mercedes-Benz for your vehicle.

These tires have been specially adapted for use with the control systems, such as ABS or ESP®.

Otherwise, certain properties, such as handling characteristics, vehicle noise and consumption could be adversely affected. Furthermore, other tire size could result in the tires rubbing against the body and axle components when loaded. This could result in damage to the tire or the vehicle.

- ▶ Only use tires, wheels and accessories that have been checked and recommended by Mercedes-Benz.

! NOTE Driving safety put at risk by retreaded tires

Retreaded tires are not checked or recommended by Mercedes-Benz, as previous damage is not always detected during the retread process.

Driving safety cannot, therefore, be guaranteed.

- ▶ Do not use used tires when their previous usage is unknown.

! NOTE Possible wheel and tire damage when driving over obstacles

Large wheels have a lower tire section width. As the section width decreases, the risk of wheels and tires being damaged when driving over obstacles increases.

- ▶ Avoid obstacles or drive over them with particular care.
- ▶ Reduce speed when driving over curbs, speed bumps, manhole covers and potholes.
- ▶ Avoid especially high curbs.

! **NOTE** Damage to electronic component parts through the use of tire-installing tools

Vehicles with a tire pressure monitoring system: there are electronic component parts in the wheel. Tire-installing tools should not be applied in the area of the valve.

Otherwise, the electronic component parts could be damaged.

- ▶ Always have tires changed at a qualified specialist workshop.

Accessories that are not approved for your vehicle by Mercedes-Benz, or are not being used correctly, can impair operating safety.

Before purchasing and using non-approved accessories, visit a qualified specialist workshop and inquire about:

- Suitability
- Legal stipulations
- Factory recommendations

Observe the following points when selecting, installing and replacing tires:

- Use only tires and wheels of the same type, design (winter tires, all-season tires) and make.
- Only install wheels of the same size and tread design on one axle (left and right).
It is only permissible to install a different wheel size to this in the event of a flat tire in order to drive to the specialist workshop.
- Only install tires of the correct size onto the wheels.
- **Vehicles with a tire pressure monitoring system:** all installed wheels must be equipped with functioning sensors for the tire pressure monitoring system.
- At temperatures below 50°F (10°C) use winter tires or all-season tires with the M+S marking on all wheels.

Winter tires bearing the  snowflake symbol in addition to the M+S marking provide the best possible grip in wintry road conditions.

- Only use tires with the same tread.
- Observe the maximum permissible speed for the installed tires.

If this is below the vehicle's maximum permissible speed, this must be indicated in an appropriate label in the driver's field of vision.

- Break in new tires at moderate speeds for the first 60 miles (100 km).
- Replace the tires after six years at the latest, regardless of wear.

For more information on wheels and tires, contact a qualified specialist workshop.

Be sure to also observe the following further related subjects:

- Notes on tire pressure (→ page 206)
- Tire and Loading Information placard
- Tire size designation, load-bearing capacity, speed rating and load index (→ page 213)
- Tire pressure table
- Notes on the emergency spare wheel (→ page 222)

Notes on changing wheels

! **WARNING** Risk of injury through different wheel sizes

Interchanging the front and rear wheels if the wheels or tires have different dimensions may severely impair the driving characteristics.

The wheel brakes or wheel suspension components may also be damaged.

- ▶ Rotate front and rear wheels only if the wheels and tires are of the same dimensions.

On vehicles that have the same size front and rear wheels, rotate the wheels according to the intervals in the tire manufacturer's warranty book in your vehicle documents. If this is not available, rotate the tires every 3,000 (5,000) to 6,000 miles (10,000 km), depending on the degree of wear. Ensure that the direction of rotation is maintained.

It is imperative to observe the instructions and safety notes on "Changing a wheel" when doing so.

Size categories of wheels

The determined vehicle speed is displayed in the instrument cluster and is important for controlling the driving safety systems and driving systems. The display accuracy of the speedometer and the odometer is legally prescribed. Determining the speed is dependent on the tire size or the rolling circumference of the tires. The rim diameter is always specified in inches.

For this reason, the vehicle control units can be coded for the following wheel size categories:

Wheel size category 1
195/65 R 16 C
205/65 R 16 C
225/60 R 16 C
225/55 R 17 C
225/55 R 17 XL
245/45 R 18 XL

Wheel size category 2
225/55 R 17 XL
235/55 R 17 XL
245/55 R 17 XL
245/45 R 18 XL
245/50 R 18 XL
245/45 R 19 XL

- i** Mercedes-Benz recommends that you stay within a wheel size category when changing a tire. In this way, you avoid recoding the control units.

Due to the legally prescribed accuracy of the speedometer and odometer displays, the following tires are not permitted for taxis and hire cars:

- Wheel size category 1
 - 195/65 R16C
- Wheel size category 2
 - 225/55 R17XL
 - 245/45 R18XL

If the wheel size category changes, you must have your vehicle's control units recoded at a qualified specialist workshop.

Information on the direction of the tires' rotation

Tires with a specified direction of rotation have additional benefits, e.g. if there is a risk of hydroplaning. You will only gain these benefits if the correct direction of rotation is observed.

An arrow on the sidewall of the tire indicates its correct direction of rotation.

You may also install a spare wheel against the direction of rotation. Observe the time restriction on use as well as the speed limitation specified on the spare wheel.

Information on storing wheels

Observe the following when storing wheels:

- Wheels that have been removed should be stored in a cool, dry and, if possible, dark place.
- Protect the tires from oil, grease and fuel.

Preparing the vehicle for a wheel change

Requirements:

- The tire-change tool kit is available.
- The vehicle is not on a slope.
- The vehicle is on solid, non-slippery and level ground.

- ▶ Apply the parking brake.
- ▶ Move the front wheels to the straight-ahead position.
- ▶ **Vehicles with automatic transmission:** shift the transmission to position **P**.
- ▶ Switch off the engine.
- ▶ Make sure that the engine cannot be started.

- ▶ **On level terrain:** place chocks or other suitable objects under the front and rear of the wheel that is diagonally opposite the wheel to be changed.
- ▶ **On slight inclines:** place chocks or other suitable objects under the wheels on the front and rear axles opposite the wheel to be changed.

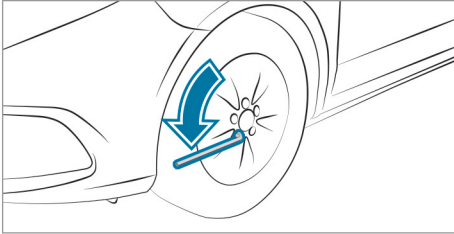

- ▶ If included in the vehicle equipment, take the tire-change tool kit out of the vehicle tool kit (→ page 202).
- ▶ If included in the vehicle equipment, remove the spare wheel from the spare wheel bracket (→ page 223).
- ▶ If necessary, remove the hub cap.
- ▶ Using the lug wrench, loosen the wheel nuts/bolts on the wheel you wish to change by about one full turn. Do not unscrew the wheel bolts/nuts completely.
- ▶ Raise the vehicle (→ page 219).

Raising the vehicle when changing a wheel

⚠ WARNING Risk of injury from incorrect positioning of the jack

If you do not position the jack correctly at the appropriate jacking point of the vehicle, the jack could tip with the vehicle raised.

- ▶ Only position the jack at the appropriate jacking point of the vehicle. The base of the jack must be positioned vertically under the jacking point of the vehicle.

⚠ WARNING Risk of injury from vehicle tipping

On slopes, the jack could tip with the vehicle raised.

- ▶ Never change a wheel on a slope.
- ▶ Consult a qualified specialist workshop.

❗ NOTE Vehicle damage from the jack

If you do not position the jack correctly at the appropriate jack support point of the vehicle, the jack could tip over with the vehicle raised.

- ▶ The jack is designed exclusively for jacking up the vehicle at the jack support points.

Requirements:

- There are no persons in the vehicle.
- The vehicle is prepared for changing a wheel (→ page 218).

Important notes on using the jack:

- Only use the vehicle-specific jack that has been tested and approved by Mercedes-Benz to raise the vehicle. If the jack is used incorrectly, it could tip over while the vehicle is raised.
- The jack is designed only to raise the vehicle for a short time while a wheel is being changed and is not suitable for carrying out maintenance work under the vehicle.
- Avoid changing a wheel on uphill and downhill slopes.
- The jack must be placed on a firm, flat and non-slip surface. If necessary, use a large, flat, load bearing and non-slip underlay.
- The base of the jack is positioned vertically under the jack support point.

Safety instructions while the vehicle is raised:

- Do not put your hands or feet under the vehicle.
- Do not lie underneath the vehicle.
- Do not start the vehicle and do not release the parking brake.
- Do not open or close any doors.

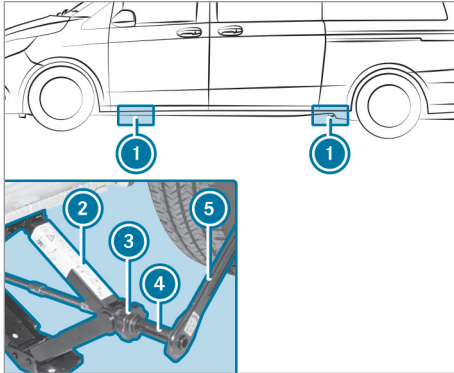

Jacking points ① (rubber stoppers) are located behind the front wheel arches and in front of the rear wheel arches.

- ▶ Place jack ② beneath corresponding jack support point ①.
- ▶ Turn handwheel ③ until the plate of jack ② sits securely on jack support point ①.
- ▶ Ensure that the base of jack ② is positioned vertically under jacking point ①.
- ▶ Assemble adapter ④ and ratchet ⑤ from the vehicle tool kit.
- ▶ Place adapter ④ and ratchet ⑤ on the hexagon nut of jack ② so that the lettering AUF/UP is visible.
- ▶ Turn ratchet wrench ⑤ in the AUF/UP direction until the tire is raised a maximum of 1.2 inch (3 cm) off the ground. When doing so, jack ② may move to one of the side support surfaces.

Removing a wheel

Requirements:

- The vehicle is raised (→ page 219).

When changing a wheel, avoid applying any force to the brake discs since this could impair the level of comfort when braking.

! **NOTE** Damage to threading from dirt on wheel bolts

- ▶ Do not place wheel bolts in sand or on a dirty surface.

- ▶ Unscrew the wheel bolts.
- ▶ Remove the wheel.

Installing a new wheel

Requirements:

- The wheel is removed (→ page 220).

! **WARNING** Risk of accident from losing a wheel

Oiled, greased or damaged wheel bolt/wheel nut threads or wheel hub/wheel mounting bolt threads can cause the wheel bolts/wheel nuts to come loose.

- ▶ Never oil or grease the threads.
- ▶ In the event of damage to the threads, contact a qualified specialist workshop immediately.
- ▶ Have the damaged wheel bolts or damaged hub threads replaced.
- ▶ Do not continue driving.

! **WARNING** Risk of injury from tightening wheel bolts and nuts

If you tighten the wheel bolts or wheel nuts when the vehicle is raised, the jack could tip.

- ▶ Only tighten wheel bolts or wheel nuts when the vehicle is on the ground.

! **NOTE** Damage to electronic component parts through the use of tire-installing tools

Vehicles with a tire pressure monitoring system: there are electronic component parts in the wheel. Tire-installing tools should not be applied in the area of the valve.

Otherwise, the electronic component parts could be damaged.

- ▶ Always have tires changed at a qualified specialist workshop.

- ▶ Observe the information on the choice of tires (→ page 216).
- ▶ Observe the instructions and safety notes on changing a wheel (→ page 216).
- ▶ For safety reasons, only use wheel bolts or wheel nuts which have been approved by Mercedes-Benz and for the wheel in question.
- ▶ Clean the wheel and wheel hub contact surfaces.
- ▶ Slide the wheel which is to be re-installed onto the wheel hub and push it on.

Lowering the vehicle after a wheel change

⚠ WARNING Risk of accident due to incorrect tightening torque

The wheels could come loose if the wheel bolts or wheel nuts are not tightened to the prescribed torque.

- ▶ Ensure that the wheel bolts or wheel nuts are tightened to the prescribed tightening torque.
- ▶ If you are not sure, do not move the vehicle. Contact a qualified specialist workshop and have the tightening torque checked immediately.

Requirements:

- The new wheel has been installed (→ page 220).

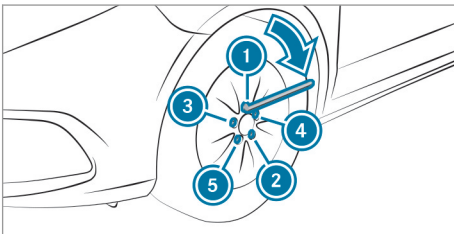

- ▶ Place the adapter and the ratchet on the hexagon head nut of the jack such that the lettering AB/DOWN is visible.
- ▶ **To lower the vehicle:** turn the ratchet of the jack counter-clockwise.
- ▶ **Steel wheels:** tighten the wheel bolts or wheel nuts evenly in a crosswise pattern in the sequence indicated (① to ⑤) and to a maximum of 200 Nm.
- ▶ **Alloy wheels:** tighten the wheel bolts or wheel nuts evenly in a crosswise pattern in the sequence indicated (① to ⑤) and to a maximum of 180 Nm.
- ▶ Check the tire pressure of the newly installed wheel and adjust it if necessary.

Vehicles with the tire pressure monitor system: all installed wheels must be equipped with functioning sensors.

- ▶ Retighten the wheel bolts to the specified tightening torque after the vehicle has been driven 31 miles (50 km).

- ① When using a wheel or spare wheel with a new or newly painted disk wheel, have the wheel bolts or wheel nuts retightened again after approximately 621 to 3,107 miles (1,000 to 5,000 km). Observe the specified tightening torque.

Information on wheel and tire combinations

General notes

Retreaded tires are not checked and recommended by Mercedes-Benz as it is not always possible to detect previous damage after retreading. For this reason, Mercedes-Benz cannot guarantee their driving safety. Do not use used tires when their previous usage is unknown.

For safety reasons, Mercedes-Benz recommends that you only use tires, wheels and accessories which have been approved by Mercedes-Benz for your vehicle.

These tires have been specially adapted for use with driving safety systems, such as ABS or ESP®.

Only use tires, wheels and accessories that have been checked and recommended by Mercedes-Benz. Certain characteristics, such as handling, vehicle noise emissions, fuel consumption, etc. may otherwise be adversely affected. Other wheel sizes may cause the tires to come into contact with the vehicle body and axle components when under load. This may result in damage to the tire or the vehicle.

Mercedes-Benz is not responsible for any damage caused by using tires, wheels or accessories other than those recommended.

Information on tires, wheels and permissible combinations can be obtained at a qualified specialist workshop.

The smaller the cross-section of a tire of a specific wheel size, the worse the driving comfort on poor road surfaces. Ride and damping comfort are reduced and the risk increases that when you drive over obstacles, damage to wheels and tires may result.

If you change wheel size on your vehicle, check it is assigned to the correct wheel size category (→ page 218). If the assignment changes without recoding the control units in the vehicle, the speedometer will not display the speed accurately. Driving safety systems and driving systems may then be operationally impaired or may detect a malfunction and switch themselves off.

You will find a table with the recommended tire pressures for various vehicle loads on the inside of the vehicle's fuel filler flap or under "Tire pressure tables" (→ page 207).

Check tire pressure regularly and only when the tires are cold.

Observe the following notes:

- Always equip the vehicle with tires of the same size on a given axle (left/right)
- Always install the same type of wheels on your vehicle at a given time (summer tires, winter tires)

You can obtain information about this from a Mercedes-Benz Commercial Van Center.

 Not all wheel/tire combinations can be installed at the factory in all countries.

Tires

R17

Tires	Steel wheels
225/55 R17 C 104/102H (106N)	6.5 J x 17 H2 ET 50
225/55 R17 C 109/107H (104H)	6.5 J x 17 H2 ET 50
225/55 R17 C 109/107T (104T)	6.5 J x 17 H2 ET 50

R17

Tires	Alloy wheels
225/55 R17 C 104/102H (106N)	7 J x 17 H2 ET 51
225/55 R17 C 109/107H (104H)	7 J x 17 H2 ET 51
225/55 R17 C 109/107T (104T)	7 J x 17 H2 ET 51

Spare wheel

Notes on the emergency spare wheel and spare wheel

Spare wheel: wheel and tire dimensions as well as the type of tire correspond to the other installed wheels.

Emergency spare wheel: wheel and/or tire dimensions as well as the type of tire are different from the wheel to be replaced. A label with a speed limit can be found on the emergency spare wheel.

An installed emergency spare wheel or spare wheel changes the driving characteristics and bears risks.

 **WARNING** Risk of accident caused by incorrect wheel and tire dimensions

When the emergency spare wheel or the spare wheel is installed, driving characteristics may be severely affected.

There is an increased risk of an accident.

To prevent hazardous situations:

- ▶ Once the spare wheel or the emergency spare wheel has been installed, check the tire pressure and adjust if necessary.
- ▶ The emergency spare wheel may only be used temporarily and must be

replaced with a standard wheel as soon as possible.

- ▶ Never install more than one emergency spare wheel.
- ▶ When operating your vehicle with the emergency spare wheel installed, adapt your driving style accordingly and drive carefully.
- ▶ Do not switch off ESP®.
- ▶ Snow chains must not be installed on the emergency spare wheel.
- ▶ Replace the emergency spare wheel after a maximum of six years, regardless of wear.

- When using an emergency spare wheel (which is different from the wheel to be replaced) a top speed of 50 mph (80 km/h) must not be exceeded.
- The tire pressure of the emergency spare wheel must be checked before starting a journey.
- Have the emergency spare wheel replaced by a qualified specialist workshop.

The following should be checked regularly, particularly prior to long journeys:

- the secure positioning of the spare tire
- the tire pressure of the spare wheel (adjust the tire pressure if necessary) (→ page 207)
- the fastenings of the spare wheel bracket

The spare wheel is located either on the left in the rear compartment or in a spare wheel bracket under the vehicle.

Replace the tires after six years at the latest, regardless of wear. This also applies to the spare wheel.

- ❗ If you have installed an emergency spare wheel or spare wheel, the tire pressure monitor will not function for this wheel. The emergency spare wheel or spare wheel is not equipped with a sensor for monitoring tire pressure.

Installing/removing the spare wheel

Removing the spare wheel in the rear compartment

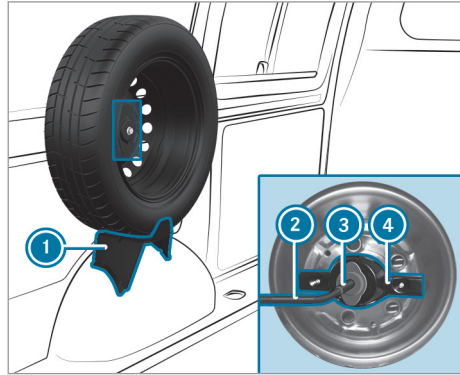

- ▶ Take auxiliary tool (3) and lug wrench (2) out of the vehicle tool kit.
- ▶ Open the tailgate/rear-end door.
- ▶ Attach auxiliary tool (3) to lug wrench (2).
- ▶ Unscrew the bolt in the middle of the wheel with lug wrench (2) and attached auxiliary tool (3).
- ▶ Remove spare wheel bracket (4).
- ▶ Remove the wheel from spare wheel bracket (1).

Installing the spare wheel in the rear compartment

- ▶ Take auxiliary tool (3) and lug wrench (2) out of the vehicle tool kit.
- ▶ Place the wheel onto spare wheel bracket (1) in the wheel arch.
- ▶ Screw on the bolt along with spare wheel bracket (4). To do so, use lug wrench (2) with attached auxiliary tool (3).
- ▶ Tighten the bolt using lug wrench (2) and attached auxiliary tool (3).
- ▶ Stow auxiliary tool (3) and lug wrench (2) in the vehicle tool kit.
- ▶ Close the tailgate/rear-end door.

Removing the spare wheel under the rear of the vehicle

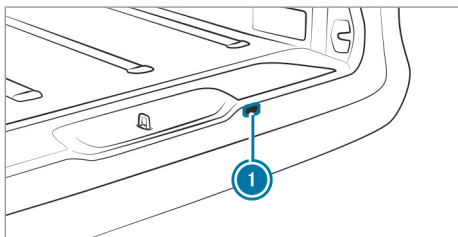

- ▶ Take the lug wrench and auxiliary tool for the spare wheel lifter out of the vehicle tool kit (→ page 202).
- ▶ Open the tailgate/rear-end door.
- ▶ Carefully pry off cover cap ① with a suitable tool, e.g. a screwdriver. Be careful not to damage the paintwork or the covering cap when doing so.

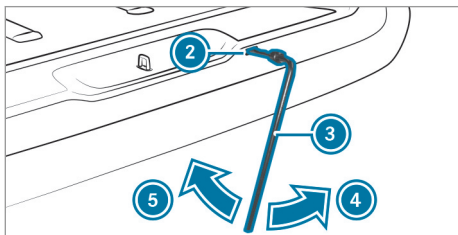

- ▶ Push auxiliary tool ② through the opening into the winch guide.
- ▶ Attach lug wrench ③ to auxiliary tool ② for the spare wheel lifter.
- ▶ Turn lug wrench ③ in the direction of arrow ⑤ until you feel resistance or until the friction clutch of the winch overwinds. The spare wheel is lowered.

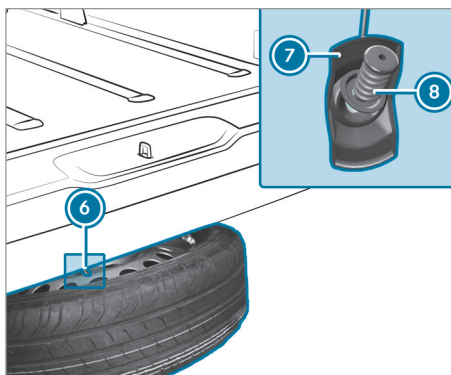

- ▶ Pull the spare wheel out from under the vehicle.
- ▶ Press cable ⑥ downwards and hold spring ⑧ at an angle against wheel gripper ⑦. Wheel gripper ⑦ is released.
- ▶ Pull wheel gripper ⑦ out of the wheel brace.

Installing the spare wheel under the rear of the vehicle

- ① Alloy wheels cannot be transported under the vehicle. In this case, transport the alloy wheel in the cargo compartment, and only turn up cable ⑥.
- ▶ Take lug wrench ③ and auxiliary tool ② for the spare wheel lifter out of the vehicle tool kit (→ page 202).
- ▶ Place the wheel on the ground with the wheel brace pointing upwards.
- ▶ Guide wheel gripper ⑦ at an angle on wire ⑥ from above into the wheel brace.
- ▶ Slide the wheel under the vehicle a little.
- ▶ Attach lug wrench ③ to auxiliary tool ② for the spare wheel lifter.
- ▶ Turn lug wrench ③ in the direction of arrow ④ until you feel resistance and the friction clutch of the winch overwinds in jerks. The wheel is firmly secured to the underside of the vehicle.
- ▶ Pull lug wrench ③ and auxiliary tool ② for the spare wheel lifter out of the opening for the winch.
- ▶ Close the winch opening with covering cap ①.
- ▶ Stow lug wrench ③ and auxiliary tool ② for the spare wheel lifter in the vehicle tool kit.
- ▶ Close the tailgate/rear-end door.

Notes on the technical data

The given data only applies to vehicles with standard equipment. You can obtain further information at a qualified specialist workshop.

On-board electronics

Notes on work on the engine electronics

! **NOTES** Premature wear through improper maintenance

Improper maintenance may cause vehicle components to wear more quickly and the vehicle's operating permit may be invalidated.

- ▶ Always have work on the engine electronics and related components carried out at a qualified specialist workshop.

Two-way radios

Installation notes for two-way radios

⚠ **WARNING** Risk of accident due to improper work on two-way radios

If two-way radios are manipulated or retrofitted incorrectly, the electromagnetic radiation from the two-way radios can interfere with the vehicle electronics and jeopardize the operating safety of the vehicle.

- ▶ You should have all work on electrical and electronic components carried out at a qualified specialist workshop.

⚠ **WARNING** Risk of accident due to improper operation of two-way radios

If you use two-way radios in the vehicle improperly, their electromagnetic radiation can disrupt the vehicle's electronics. This is the case in the following situations, in particular:

- The two-way radio is not connected to an exterior antenna.
- The exterior antenna is installed incorrectly or is not a low-reflection antenna.

This could jeopardize the operating safety of the vehicle.

- ▶ Have the low-reflection exterior antenna installed at a qualified specialist workshop.

- ▶ When operating two-way radios in the vehicle, always connect them to the low-reflection exterior antenna.

! **NOTE** Invalidation of the operating permit due to failure to comply with the instructions for installation and use

The operating permit may be invalidated if the instructions for installation and use of two-way radios are not observed.

- ▶ Only use approved frequency bands.
- ▶ Observe the maximum permissible output power in these frequency bands.
- ▶ Only use approved antenna positions.

Use Technical Specification ISO/TS 21609 (Road Vehicles - EMC guidelines for installation of aftermarket radio frequency transmitting equipment) when retrofitting two-way radios. Comply with the legal requirements for detachable parts.

If your vehicle has installations for two-way radio equipment, use the power supply or antenna connections intended for use with the installation. Observe the manufacturer's supplements during installation.

Two-way radio transmission output

The maximum transmission outputs (PEAK) at the base of the antenna must not exceed the values in the following table:

Frequency band and maximum transmission output

Frequency band	Maximum transmission output
Short wave 3 - 54 MHz	100 W
4 m waveband 74 - 88 MHz	30 W
2 m waveband 144 - 174 MHz	50 W
Trunked radio system/Tetra 380 - 460 MHz	10 W

Frequency band	Maximum transmission output
70 cm waveband 420 – 450 MHz	35 W
Two-way radio (2G/3G/4G)	10 W

The following devices can be used in the vehicle without restrictions:

- Two-way radios with a maximum transmission output of up to 100 mW
- Two-way radios with transmitter frequencies in the 380 – 410 MHz frequency band and a maximum transmission output of up to 2W (trunked radio system/Tetra)
- Mobile phones (2G/3G/4G)

There are no restrictions when positioning the antenna on the outside of the vehicle for the following frequency bands:

- Trunked radio system/Tetra
- 70 cm waveband
- 2G/3G/4G

Vehicle identification plate, vehicle identification number (VIN) and engine number

Vehicle identification plate

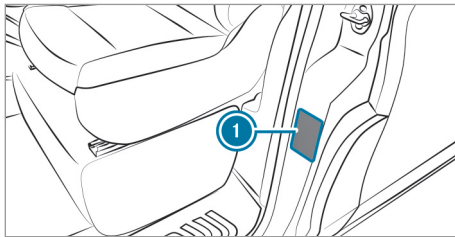

Vehicle identification plate ① is on the B-pillar on the driver's side.

- ① The data is vehicle-specific and can differ from that shown. Always observe the specifications on your vehicle's identification plate.

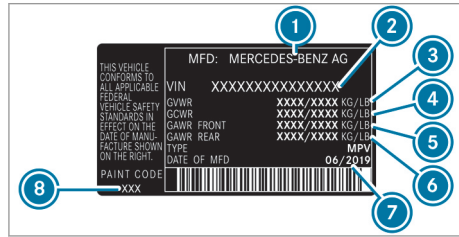

Example: vehicle identification plate (US vehicles)

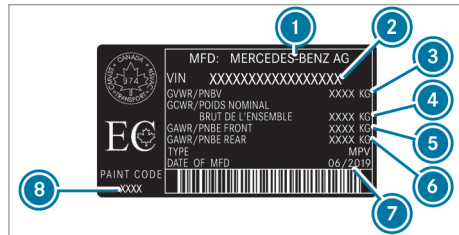

Example: vehicle identification plate (Canada vehicles)

- ① Vehicle manufacturer
- ② VIN
- ③ Permissible gross mass of the vehicle
- ④ Permissible gross mass of vehicle combination
- ⑤ Maximum permissible front axle load, vehicle model
- ⑥ Maximum permissible rear axle load, engine displacement
- ⑦ Date of manufacture
- ⑧ Paint code

Engraved VIN in the engine compartment

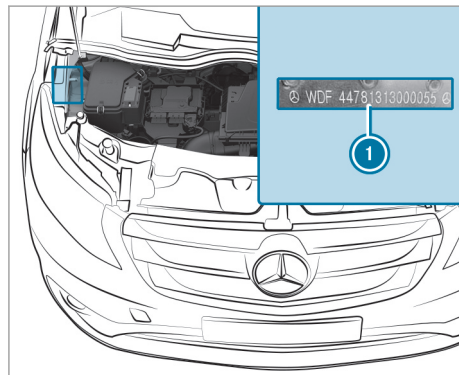

VIN  is engraved into the longitudinal member in the engine compartment next to the fuse box.

Engine number

The engine number is stamped onto the crankcase. You can obtain further information from a qualified specialist workshop.

Operating fluids and capacities

Notes on operating fluids

 **WARNING** Risk of injury from operating fluids harmful to your health

Operating fluids may be poisonous and harmful to your health.

- ▶ Observe the text on the original containers when using, storing or disposing of operating fluids.
- ▶ Always store operating fluids sealed in their original containers.
- ▶ Always keep children away from operating fluids.

 **ENVIRONMENTAL NOTE** Environmental pollution due to disposing of operating fluids in a non-environmentally responsible manner

Incorrect disposal of operating fluids can cause considerable damage to the environment.

- ▶ Dispose of operating fluids in an environmentally responsible manner.

Operating fluids include the following:

- Fuels
- Lubricants
- Coolant
- Brake fluid
- Windshield washer fluid
- Climate control system refrigerants

Only use products which have been approved for your vehicle by Mercedes-Benz. Damage caused by the use of products that have not been approved is not covered by the Mercedes-Benz guarantee or goodwill gestures.

You can identify operating fluids approved by Mercedes-Benz by the following inscriptions on the container:

- MB-Freigabe (e.g. MB-Freigabe 229.51)
- MB-Approval (e.g. MB-Approval 229.51)

Further information on approved operating fluids is available at the following locations:

- In the MB Specifications for operating fluids at <https://bevo.mercedes-benz.com> (by entering the designation)
- At a qualified specialist workshop

Additives (special additives) for approved operating fluids are neither required nor permitted. Approved fuel additives are the exception. Additives can cause engine damage and must therefore not be added to the operating fluids.

The use of additives is always the responsibility of the vehicle operator. The use of additives may result in the restriction or loss of your warranty claims.

 **WARNING** Risk of fire or explosion from fuel

Fuels are highly flammable.

- ▶ Fire, open flames, smoking and creation of sparks must be avoided.
- ▶ Switch off the ignition and, if available, the stationary heater, before and while refueling the vehicle.

 **WARNING** Risk of injury from fuels

Fuels are poisonous and hazardous to your health.

- ▶ Do not swallow fuel or let it come into contact with skin, eyes or clothing.
- ▶ Do not inhale fuel vapor.
- ▶ Keep children away from fuel.
- ▶ Keep doors and windows closed during the refueling process.

If you or other people come into contact with fuel, observe the following:

- ▶ Immediately rinse fuel off your skin with soap and water.
- ▶ If fuel comes into contact with your eyes, immediately rinse them thoroughly with clean water. Seek medical attention immediately.

- ▶ If you swallow fuel, seek medical attention immediately. Do not induce vomiting.
- ▶ Change immediately out of clothing that has come into contact with fuel.

Fuel

Notes on fuel grades on vehicles with a gasoline engine

Observe the notes on operating fluids (→ page 227).

! NOTE Damage due to incorrect fuel

Even small amounts of the wrong fuel could result in damage to the fuel system, engine and exhaust system.

- ▶ Only refuel using low-sulfur, unleaded premium grade gasoline with at least 91 AKI/95 RON/95 ROZ.

This fuel may contain up to 10% ethanol by volume. Your vehicle is suitable for use with E10 fuel.

Never refuel with the following:

- Diesel
 - Gasoline with more than 10% ethanol by volume, e.g. E15, E20, E85, E100
 - Gasoline with more than 3% methanol by volume, e.g. M15, M30, M50, M85, M100
 - Gasoline with additives containing metal
- ▶ Do not mix such fuels with the fuel recommended for your vehicle.

If you have accidentally refueled with the wrong fuel:

- ▶ Do not switch the ignition on.
- ▶ Consult a qualified specialist workshop.

! NOTE Malfunctions due to contaminated fuel

Fuel contamination can lead to malfunctions in the fuel system.

- ▶ If you are using drums or canisters to refuel the vehicle, you should filter the fuel before filling.

If the available fuel is not sufficiently low in sulfur, this can produce unpleasant odors.

The recommended octane number for your vehicle can be found on the instruction label in the fuel filler flap (→ page 106).

Further information on fuel can be obtained at a gas station or a qualified specialist workshop.

Notes on additives in gasoline

Observe the notes on operating fluids (→ page 227).

! NOTE Damage from use of unsuitable additives

Even small amounts of the wrong additive may lead to malfunctions.

- ▶ Only add cleaning additives recommended for Mercedes-Benz to the fuel.

Mercedes-Benz recommends using brand-name fuels with additives.

In some countries, the available fuel may not contain sufficient amounts of additives. Deposits could build up in the fuel injection system as a result.

In this case, in consultation with a Mercedes-Benz Commercial Van Center, the fuel should be mixed with the cleaning additive recommended by Mercedes-Benz.

You must observe the notes and mixing ratios indicated on the tank.

Tank content and reserve fuel

Capacity

Model	Total capacity
All models	Approx. 18.5 US gal (70 liters)
Model	Of which reserve fuel
All models	Approx. 3.2 US gal (12 liters)

Engine oil

Notes on engine oil

Observe the notes on operating fluids (→ page 227).



! **NOTE** Engine damage caused by an incorrect oil filter, incorrect oil or additives

- ▶ Do not use engine oils or oil filters other than those which meet the specifications necessary for the prescribed service intervals.
- ▶ Do not alter the engine oil or oil filter in order to achieve longer change intervals than prescribed.
- ▶ Do not use additives.
- ▶ Have the engine oil changed after the prescribed intervals.

Mercedes-Benz recommends having the oil changed at a qualified specialist workshop.

Further information on engine oil and oil filter:

- In the MB Specifications for operating fluids at <https://bevo.mercedes-benz.com> (by entering the designation)
- At a qualified specialist workshop

Quality and capacity of engine oil

MB-Freigabe or MB-Approval

Models	MB-Freigabe or MB-Approval
All models	229.5, 229.6*

* Recommended for lowest possible fuel consumption (lowest SAE viscosity class in each case; observe possible restrictions of the approved SAE viscosity classes).

To achieve the lowest possible fuel consumption, it is recommended to use the engine oil specifications marked in the table for the lowest SAE viscosity class. Observe any possible restrictions of the approved SAE viscosity classes.

If the engine oils listed in the table are not available, you may add a maximum of 1.1 US qt (1.0 l)

of the engine oils with MB-Freigabe or MB-Approval 229.3 or ACEA A3/B4.

Replacement amount

Engine oil	Approximately 2 US gal (7.7 l)
------------	--------------------------------

Transmission oil

Automatic transmission

Operating fluid: automatic transmission fluid

Product description/number	Maintenance interval
Mobil ATF 134 FE	-
Valvoline ATF Pro 236.15	
MB Sheet Number 236.15	

Further information may be obtained at any qualified specialist workshop.

Rear axle

Operating fluid: transmission oil

Product description/number	Maintenance interval
Mobilube FE 75W-85	-
Mobilube FE Plus NG 75W-85	
MB Sheet Number 235.7	

Further information may be obtained at any qualified specialist workshop.

Notes on brake fluid

Observe the notes on operating fluids (→ page 227).

! **WARNING** Risk of an accident due to vapor pockets forming in the brake system

The brake fluid constantly absorbs moisture from the air. This lowers the boiling point of the brake fluid. If the boiling point is too low, vapor pockets may form in the brake system when the brakes are applied hard.

This causes the braking effect to be impaired.

- ▶ Have the brake fluid renewed at the specified intervals.

! **NOTE** Damage to paint, plastic or rubber by brake fluid

There is a risk of damage to property if brake fluid comes into contact with paint, plastic or rubber.

- ▶ If paint, plastic or rubber comes into contact with brake fluid, rinse with water immediately.

Observe the notes on paintwork/matte finish paintwork care (→ page 184).

Have the brake fluid renewed every two years at a qualified specialist workshop.

Only use brake fluid approved by Mercedes-Benz in accordance with MB-Freigabe or MB-Approval 331.0.

Information on brake fluid is available at the following locations:

- In the MB Specifications for operating fluids 331.0
 - At <https://bevo.mercedes-benz.com>
 - In the BeVo app
- At a qualified specialist workshop

Coolant

Notes on coolant

Observe the notes on operating fluids (→ page 227).

⚠ WARNING - Risk of fire and injury from antifreeze

If antifreeze comes into contact with hot component parts in the engine compartment, it may ignite.

- ▶ Allow the engine to cool down before adding antifreeze.
- ▶ Make sure that no antifreeze spills out next to the filler opening.
- ▶ Thoroughly clean off any antifreeze from component parts before starting the vehicle.

! **NOTE** Damage caused by incorrect coolant

- ▶ Only add coolant that has been pre-mixed with the required antifreeze protection.

Information on coolant is available at the following locations:

- In the MB Specifications for operating fluids 320.1
 - At <https://bevo.mercedes-benz.com>
 - In the BeVo app
- At a qualified specialist workshop

! **NOTE** Overheating at high outside temperatures

If an inappropriate coolant is used, the engine cooling system is not sufficiently protected against overheating and corrosion at high outside temperatures.

- ▶ Always use coolant approved by Mercedes-Benz .
- ▶ Observe the instructions in the MB Specifications for operating fluids 320.1.

! **NOTE** Paintwork damage due to coolant

- ▶ Do not spill coolant on painted surfaces.

Have the coolant regularly replaced at a qualified specialist workshop.

Note the proportion of anti-corrosion agent/antifreeze in the engine cooling system within the following temperature ranges:

- At least 50% (antifreeze protection up to about -35°F (-37°C))
- Maximum 55% (antifreeze protection up to -49°F (-45°C))

Coolant capacities

Coolant capacity

Model	Capacity
All models	Approx. 11 US qt (10.4 l)

Windshield washer fluid

Notes on windshield washer fluid

Observe the notes on operating fluids (→ page 227).

⚠ WARNING - Risk of fire and injury from windshield washer concentrate

Windshield washer concentrate is highly flammable. It could ignite if it comes into contact with hot engine component parts or the exhaust system.

- ▶ Make sure that no windshield washer concentrate spills out next to the filler opening.

! **NOTE** Damage to the exterior lighting due to unsuitable windshield washer fluid

Unsuitable windshield washer fluid may damage the plastic surface of the exterior lighting.

- ▶ Only use windshield washer fluid which is also suitable for use on plastic surfaces, e.g. MB SummerFit or MB WinterFit.

! **NOTE** Blocked spray nozzles caused by mixing windshield washer fluids

- ▶ Do not mix MB SummerFit and MB WinterFit with other windshield washer fluids.

Do not use distilled or de-ionized water. Otherwise, the fill level sensor may give a false reading.

Recommended windshield washer fluid:

- Above freezing point: e.g. MB SummerFit
- Below freezing point: e.g. MB WinterFit

For the correct mixing ratio, refer to the information on the anti-freeze container.

Mix the washer fluid with windshield washer fluid all year round.

Refrigerant

Notes on refrigerant

Observe the notes on operating fluids (→ page 227).

- ① Your vehicle's climate control system is filled with the refrigerant R134a. The refrigerant R134a contains fluorinated greenhouse gas.

! **NOTE** Damage due to incorrect coolant

Using the wrong coolant can damage the air conditioning system.

- ▶ Only use the refrigerant R134a or the PAG oil approved by Mercedes-Benz for your vehicle.
- ▶ The approved PAG oil must not be mixed with any PAG oil that is not approved for the refrigerant R134a.

Maintenance work, such as adding refrigerant or replacing components, may be carried out only by a qualified specialist workshop. All applicable regulations relating to this and the SAE J639 standard must be adhered to.

All work on the climate control system should always be carried out at a qualified specialist workshop.

The information label for the refrigerant to be used can be found on the radiator cross-member.

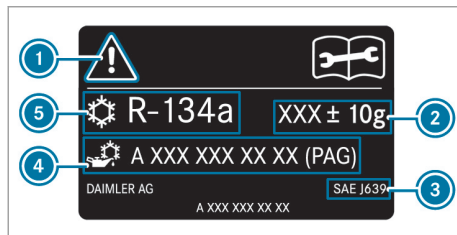

Example: refrigerant information label

- ① Warning symbols
- ② Refrigerant capacity
- ③ Applicable standards
- ④ PAG oil part number
- ⑤ Refrigerant type

Warning symbols ① refer to the following:

- Potential dangers
- The performance of maintenance work at a qualified specialist workshop

Refrigerant capacity

Front air conditioning

Model	Refrigerant
All models	21.2 oz (600 g)
Model	PAG oil
All models	2.8 oz (79 g)

Rear air conditioning system

Model	Refrigerant
All models	33.5 oz (950 g)
Model	PAG oil
All models	4.9 oz (139 g)

Vehicle data**Information on vehicle dimensions**

The following section contains important technical data for your vehicle. Your vehicle documents contain further vehicle-specific and equipment-dependent technical data such as vehicle dimensions and weights.

The values specified may vary as a result of the following variables:

- Tires
- Loading
- Condition of the suspension
- Optional equipment

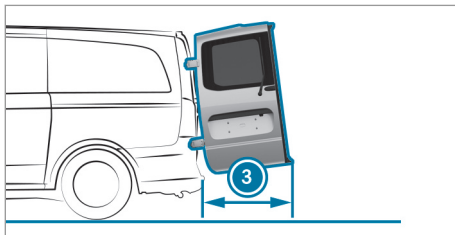
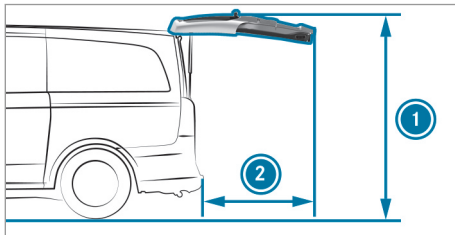
**Opening range**

Cargo Van	
① Height of the tailgate when opened	86.0 in (2185 mm)
② Opening range of the tailgate	41.2 in (1047 mm)
③ Opening range of the rear-end doors	33.4 in (849 mm)
Passenger Van	
① Height of the tailgate when opened	84.6 in (2150 mm)
② Opening range of the tailgate	41.2 in (1047 mm)
③ Opening range of the rear-end doors	33.4 in (849 mm)

Vehicle dimensions

Cargo Van	
Vehicle length	202.4 in (5140 mm)
Vehicle width including outside mirrors	88.3 in (2244 mm)
Vehicle width excluding outside mirrors	75.9 in (1928 mm)
Load width	50.0 in (1270 mm)
Max. load width	66.3 in (1685 mm)
Vehicle height	
Loading height	53.8 in (1367 mm)
Wheelbase	126.0 in (3200 mm)
Passenger Van	
Vehicle length	202.4 in (5140 mm)
Vehicle width including outside mirrors	88.3 in (2244 mm)
Vehicle width excluding outside mirrors	75.9 in (1928 mm)

Passenger Van	
Load width	47.4 in (1205 mm)
Max. load width	61.1 in (1552 mm)
Vehicle height	
Loading height	52.2 in (1326 mm)
Wheelbase	126.0 in (3200 mm)

Trailer hitch

Notes on the trailer hitch

⚠ WARNING Risk of accident due to impermissible attachment of a trailer tow hitch

If you install a trailer tow hitch or other components, the longitudinal frame member is weakened and can break. The trailer may become detached from the vehicle.

There is a risk of an accident.

Only retrofit a trailer tow hitch if permissible.

Observe the notes on trailer operation (→ page 131).

Retrofitting a trailer hitch is only permissible if a towing capacity is specified in your vehicle documents.

You can obtain further information on the trailer hitch at a qualified specialist workshop.

Mercedes-Benz recommends having a trailer hitch retrofitted at a Mercedes-Benz Van Dealer.

Only use a trailer hitch which has been tested and specially approved by Mercedes-Benz for your vehicle.

Only use a ball neck for your Metris trailer hitch if it has been approved for your vehicle. Notes on the permissible dimensions of the ball neck can also be found on the identification plate of the trailer hitch.

Trailer loads

Make sure that you adhere to the local legal requirements for trailer loads. Use a calibrated weighing machine to check that the weight restrictions have been complied with before you start your journey.

The permissible weights and loads which must not be exceeded can also be obtained from the following sources of information:

- Vehicle documents
- The type plates of the trailer hitch, trailer and vehicle

The values approved by the manufacturer can be found in the following table. If the values differ, the lowest value applies.

Maximum permissible gross weight, axle loads, trailer loads and noseweight

Gross vehicle weight GVWR	6614 lbs (3000 kg)
Front axle load GAWR (FA)	3307 lbs (1500 kg)
Rear axle load GAWR (RA)	3307 lbs (1500 kg)
Permissible gross weight of vehicle combination ¹ GCWR	11,614 lbs (5268 kg)
Towing capacity, braked ² GTW	5000 lbs (2268 kg)
Noseweight of the trailer drawbar TWR	500 lbs (227 kg)

¹ Maximum permissible gross weight of vehicle with trailer.

² Maximum permissible gross mass of the trailer, for trailers with independent brake system

Cargo tie-down points and carrier systems

Loading capacity of the cargo tie-down points and tie-down eyes

Observe the notes on securing loads (→ page 168).

Nominal tensile load is the maximum permissible pulling force on the cargo tie-down point.

Tie-down eyes

Nominal tensile load of tie-down eyes

Tie-down eyes	Nominal tensile load
Tourer	786.5 lbf (350 daN)
Cargo Van	1124.0 lbf (500 daN)

Guide and loading rails

Rated tensile force of the cargo tie-down point of a guide or loading rail

Cargo tie-down point	Nominal tensile load
Guide rails	786.5 lbf (350 daN)
Loading rails on cargo compartment floor	1124.0 lbf (500 daN)
Loading rail on side wall	225.0 lbf (100 daN)

The values specified apply only to loads resting on the cargo compartment floor if you observe the following:

- The load is secured to two cargo tie-down points on the rail
- The distance to the nearest load-securing point on the same rail is approximately 3 ft (1 m)

Information about roof luggage racks

Observe the notes on the carrier systems (→ page 173).

! **NOTE** Risk of accident if the maximum permissible roof load is exceeded

If the weight of the roof luggage, including the roof luggage rack, exceeds the maximum permissible roof load, there is a risk of an accident.

- ▶ Ensure that the weight of the roof luggage and roof luggage rack does not exceed the maximum permissible roof load.
- ▶ Arrange the supporting feet of the roof luggage rack at an even distance from each other.
- ▶ Install the basic carrier bars for rail in front of and behind the mid-section support.

Maximum roof load / pairs of roof rack supports

Maximum roof load	Minimum number of pairs of supports
331 lbs (150 kg)	3

This information applies if the load is distributed evenly across the entire roof area.

If the roof luggage rack is shorter, reduce the load proportionately. The maximum load per pair of roof rack supports is 110 lbs (50 kg). The maximum load of basic carrier bars for rail is 220 lbs (100 kg).

The driving, braking and steering characteristics of the vehicle will change with the type of load, the weight and the center of gravity of the load. Comply with the loading guidelines and further information about load distribution (→ page 167).

Display messages

Introduction

Notes on display messages

⚠ WARNING Risk of accident due to an instrument cluster malfunction

If the instrument cluster has failed or malfunctioned, you may not notice restrictions to safety-relevant system functions.

The operating safety of your vehicle may be impaired.

- ▶ Drive on carefully.
- ▶ Have the vehicle checked immediately at a qualified specialist workshop.

The on-board computer shows messages and warnings from specific systems on the instrument cluster display. Ensure that your vehicle is operating safely at all times.

If you are uncertain regarding the operational safety of your vehicle, park the vehicle safely as soon as possible. Inform a qualified specialist workshop.

Display messages with graphic symbols are simplified in the Operator's Manual and may differ from the symbols on the display.

Vehicles without steering-wheel buttons

A warning tone will also sound for specific display messages.

Please act in accordance with the display messages and follow the additional notes in this Operator's Manual.

You can hide low-priority display messages using the **(R)** button on the instrument cluster. The display messages will be saved to the message memory. Rectify the cause of a display message as quickly as possible.

High-priority display messages cannot be hidden. The display will show these display messages permanently until the cause of the display message has been rectified.

Vehicles with steering-wheel buttons

The display shows high-priority display messages in red. A warning tone will also sound for specific display messages.

Please act in accordance with the display messages and follow the additional notes in this Operator's Manual.

You can hide low-priority display messages using the **[OK]** or **[↔]** steering-wheel button. The display messages will be saved to the message memory. Rectify the cause of a display message as quickly as possible.

High-priority display messages cannot be hidden. The display will show these display messages permanently until the cause of the display message has been rectified.

Calling up saved display messages

Vehicles without steering-wheel buttons

The on-board computer saves specific display messages to the message memory. You can call up the saved display messages. Use the buttons on the instrument cluster.

- ▶ Press the **(M)** button to select the message memory. If display messages are available, the display will show the number of saved messages. If there are no display messages, the display will show **No Messages**.
- ▶ Press the **(R)** button to scroll forwards through the display messages. After the last saved display message, the display will again show the start screen of the message memory with the number of saved messages.
- ▶ Press the **(M)** button to jump to the start screen of the message memory.

Vehicles with steering-wheel buttons



The on-board computer saves specific display messages to the message memory. You can call up the saved display messages. Use the buttons on the steering wheel.

- ▶ With the **[◀]** or **[▶]** button, select the **Service** menu.
- ▶ With the **[▼]** or **[▲]** button, select **Announcements**. The bar will show the number of saved messages.
- ▶ Press **[OK]** to confirm. The first saved display message will be displayed. If there are no display messages, the display will show **No Messages**.
- ▶ Press the **[▼]** or **[▲]** button to scroll through the display messages. All saved display messages are numbered in the message memory. The current message number is shown on the lowest bar of the dis-

play as a means of orientation, together with the number of saved display messages.

- ▶ Press  to exit the display messages screen.

Safety systems

Display messages	Possible causes/consequences and ▶ Solutions
 <p>ABS, ESP Inoperative</p>	<p>* ABS, BAS, hill start assist and ESP® as well as its driving safety systems are unavailable due to a malfunction. ATTENTION ASSIST is deactivated and other driving systems could be automatically deactivated. The brake system continues to function normally, but without the functions listed above.</p> <div style="border: 1px solid gray; padding: 5px; background-color: #f0f0f0;"> <p>▲ WARNING Risk of skidding if ABS and ESP® are malfunctioning</p> <p>The wheels may block during braking and ESP® does not perform any vehicle stabilization. The steerability and braking characteristics are heavily impaired and the braking distance may increase. In addition, other driving safety systems are switched off.</p> <ul style="list-style-type: none"> ▶ Drive on carefully. ▶ Have ABS and ESP® checked immediately at a qualified specialist workshop. </div> <ul style="list-style-type: none"> ▶ Switch the engine off, wait briefly and start the engine again. ▶ Check whether the display message has disappeared and ESP® is operational. <p>If the display message continues to be shown:</p> <ul style="list-style-type: none"> ▶ Drive on carefully. ▶ Consult a qualified specialist workshop immediately.
 <p>Inoperative See Operator's Manual</p>	<p>* ABS, BAS, hill start assist and ESP® as well as its driving safety systems are unavailable due to a malfunction. ATTENTION ASSIST is deactivated and other driving systems could be automatically deactivated. The brake system continues to function normally, but without the functions listed above.</p> <div style="border: 1px solid gray; padding: 5px; background-color: #f0f0f0;"> <p>▲ WARNING Risk of skidding if ABS and ESP® are malfunctioning</p> <p>The wheels may block during braking and ESP® does not perform any vehicle stabilization. The steerability and braking characteristics are heavily impaired and the braking distance may increase. In addition, other driving safety systems are switched off.</p> <ul style="list-style-type: none"> ▶ Drive on carefully. </div>

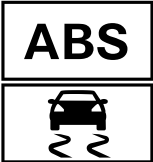
Display messages	Possible causes/consequences and ► Solutions
 <p>ABS, ESP Curr. Unavail.</p>	<ul style="list-style-type: none"> ► Have ABS and ESP[®] checked immediately at a qualified specialist workshop. <p>* ABS, BAS, hill start assist and ESP[®] as well as its driving safety systems are temporarily unavailable. ATTENTION ASSIST is deactivated and other driving systems could be automatically deactivated.</p> <p>For example, the on-board electrical system voltage may be insufficient.</p> <p>The brake system continues to function normally, but without the functions listed above.</p> <div style="background-color: #f0f0f0; padding: 5px; border: 1px solid #ccc;"> <p>▲ WARNING Risk of skidding if ABS and ESP[®] are malfunctioning</p> <p>The wheels may block during braking and ESP[®] does not perform any vehicle stabilization.</p> <p>The steerability and braking characteristics are heavily impaired and the braking distance may increase. In addition, other driving safety systems are switched off.</p> <ul style="list-style-type: none"> ► Drive on carefully. ► Have ABS and ESP[®] checked immediately at a qualified specialist workshop. </div> <ul style="list-style-type: none"> ► Continue to drive carefully on a suitable stretch of road, making slight steering movements at a speed above 12 mph (20 km/h). ► Switch the engine off, wait briefly and start the engine again. ► Check whether the display message has disappeared and ESP[®] is operational. <p>If the display message continues to be shown:</p> <ul style="list-style-type: none"> ► Drive on carefully. ► Consult a qualified specialist workshop immediately.
 <p>Currently Unavail. See Operator's Manual</p>	<p>* ABS, BAS, hill start assist and ESP[®] as well as its driving safety systems are temporarily unavailable. ATTENTION ASSIST is deactivated and other driving systems could be automatically deactivated.</p> <p>The on-board electrical system voltage may be insufficient, for example.</p> <p>The brake system continues to function normally, but without the functions listed above.</p> <div style="background-color: #f0f0f0; padding: 5px; border: 1px solid #ccc;"> <p>▲ WARNING Risk of skidding if ABS and ESP[®] are malfunctioning</p> <p>The wheels may block during braking and ESP[®] does not perform any vehicle stabilization.</p> </div>





Display messages	Possible causes/consequences and ► Solutions
	<p>The steerability and braking characteristics are heavily impaired and the braking distance may increase. In addition, other driving safety systems are switched off.</p> <ul style="list-style-type: none"> ► Drive on carefully. ► Have ABS and ESP® checked immediately at a qualified specialist workshop. <p>► Drive on carefully and, on a suitable stretch of road, make some slight steering movements at a speed above 12 mph (20 km/h).</p> <p>► Check whether the display message has disappeared and ESP® is operational.</p> <p>If the display message continues to be shown:</p> <ul style="list-style-type: none"> ► Drive on carefully. ► Consult a qualified specialist workshop immediately.
 <p>Front Passenger Airbag Disabled</p>	<p>* The co-driver airbag is disabled while the vehicle is in motion even though an adult or a person with a corresponding stature is occupying the co-driver seat.</p> <p>If additional forces are applied to the seat or the co-driver is not sitting on the sitting surface properly (→ page 30), the weight the system detects may be too low.</p> <div style="border: 1px solid black; padding: 5px; margin: 10px 0;"> <p>▲ WARNING Risk of injury or fatal injury due to a disabled front passenger airbag</p> </div> <p>If the front passenger airbag is disabled, the front passenger airbag will not be deployed in the event of an accident and cannot perform its intended protective function.</p> <p>A person in the front passenger seat could then, for example, come into contact with the vehicle's interior, especially if the person is sitting too close to the cockpit.</p> <ul style="list-style-type: none"> ► Make sure, both before and during the journey, that the status of the front passenger airbag is correct. <ul style="list-style-type: none"> ► Stop the vehicle immediately in accordance with the traffic conditions. ► Secure the vehicle against rolling away. ► Ensure that no objects have become trapped beneath the co-driver seat. ► Switch off the ignition. ► The co-driver must get out of the vehicle. ► Make sure that the co-driver seat is unoccupied, close the co-driver door and switch on the ignition. ► Observe the PASSENGER AIRBAG OFF indicator lamp on the center console and the display messages. ► With the seat unoccupied and the ignition switched on, check the following:



Display messages	Possible causes/consequences and ► Solutions
	<ul style="list-style-type: none"> • The PASSENGER AIRBAG OFF indicator lamp must light up continuously. If the indicator lamp is lit, the occupant classification system (OCS) has disabled the co-driver airbag (→ page 30). • The display must not show the messages Front Passenger Airbag Enabled or Front Passenger Airbag Disabled. <p>► Wait for at least one minute until the necessary system checks have been completed.</p> <p>► Ensure that the display does not show either of the two display messages about the co-driver airbag.</p> <p>If these conditions are met, the co-driver seat can be occupied again.</p> <p>If these conditions are not met, the Occupant Classification System (OCS) is malfunctioning.</p> <p>► Consult a qualified specialist workshop immediately.</p> <p>Further information on airbag shutoff can be found under "Occupant classification system (OCS)" (→ page 30).</p>
<p>Front Passenger Airbag Disabled See Operator's Manual</p>	<p>* The front passenger airbag is disabled while the vehicle is in motion even though an adult or a person with a corresponding build is occupying the front passenger seat.</p> <p>If additional forces are applied to the seat or the front passenger is not sitting on the seat surface properly (→ page 30), the weight the system detects may be too low.</p> <div style="border: 1px solid gray; padding: 5px; margin: 10px 0;"> <p>▲ WARNING Risk of injury or fatal injury due to a disabled front passenger airbag</p> <p>If the front passenger airbag is disabled, the front passenger airbag will not be deployed in the event of an accident and cannot perform its intended protective function.</p> <p>A person in the front passenger seat could then, for example, come into contact with the vehicle's interior, especially if the person is sitting too close to the cockpit.</p> <p>► Make sure, both before and during the journey, that the status of the front passenger airbag is correct.</p> </div> <ul style="list-style-type: none"> ► Stop the vehicle immediately in accordance with the traffic conditions. ► Secure the vehicle against rolling away. ► Ensure that no objects have become trapped beneath the front passenger seat. ► Switch off the ignition. ► The front passenger must get out of the vehicle. ► Make sure that the front passenger seat is unoccupied, close the front passenger door and switch on the ignition. ► Observe the PASSENGER AIRBAG OFF indicator lamp on the center console and the display messages.

Display messages	Possible causes/consequences and ► Solutions
	<p>► With the seat unoccupied and the ignition switched on, check the following:</p> <ul style="list-style-type: none"> • The PASSENGER AIRBAG OFF indicator lamp must light up continuously. If the indicator lamp is lit, the occupant classification system (OCS) has disabled the front passenger airbag (→ page 30). • The display must not show the messages Front Passenger Airbag Enabled See Operator's Manual or Front Passenger Airbag Disabled See Operator's Manual. <p>► Wait for at least one minute until the necessary system checks have been completed.</p> <p>► Ensure that the display does not show either of the two display messages about the front passenger airbag.</p> <p>If these conditions are met, the front passenger seat can be occupied again.</p> <p>If these conditions are not met, the Occupant Classification System (OCS) is malfunctioning.</p> <p>► Consult a qualified specialist workshop immediately.</p> <p>Further information on airbag shutoff can be found under "Occupant classification system (OCS)" (→ page 30).</p>
<div data-bbox="215 861 369 942" data-label="Image"> </div> <p data-bbox="207 946 423 996">Front Passenger Airbag Enabled</p>	<p>* The co-driver's airbag is enabled while the vehicle is in motion although:</p> <ul style="list-style-type: none"> • the front passenger seat is occupied by a child in a child restraint system or a person of smaller stature. or • the front passenger seat is not occupied. <p>The system may detect objects or forces that are adding to the weight applied to the seat.</p> <div data-bbox="505 1118 1126 1202" data-label="Text" style="background-color: #f0f0f0; padding: 5px;"> <p>⚠ WARNING Risk of injury or death when using a rearward-facing child restraint system while the front passenger airbag is enabled</p> </div> <p data-bbox="518 1213 1093 1313">If you secure a child in a rearward-facing child restraint system on the front passenger seat and the PASSENGER AIR BAG OFF indicator lamp is off, the front passenger airbag can deploy in the event of an accident.</p> <p data-bbox="518 1322 877 1347">The child could be struck by the airbag.</p> <p data-bbox="518 1356 1087 1406">Always ensure that the front passenger airbag is disabled. The PASSENGER AIR BAG OFF indicator lamp must be lit.</p> <p data-bbox="518 1415 1093 1489">NEVER use a rearward-facing child restraint system on a seat with an ENABLED FRONT AIRBAG. This can result in the DEATH of or SERIOUS INJURY to the CHILD.</p> <p>► Stop the vehicle immediately in accordance with the traffic conditions.</p> <p>► Secure the vehicle against rolling away.</p>







Display messages	Possible causes/consequences and ► Solutions
	<ul style="list-style-type: none"> ► Ensure that no objects have become trapped beneath the front passenger seat. ► Switch off the ignition. ► Open the front passenger door. ► Remove the child and the child restraint system from the front passenger seat. ► Make sure there are no objects applying additional weight to the seat. The system may otherwise detect the additional weight and interpret the vehicle occupant's weight on the front passenger seat as greater than it actually is. ► Make sure that the front passenger seat is unoccupied, close the front passenger door and switch on the ignition. ► Observe the PASSENGER AIRBAG OFF indicator lamp on the center console and the display. ► With the seat unoccupied and the ignition switched on, check the following: <ul style="list-style-type: none"> • The PASSENGER AIRBAG OFF indicator lamp must light up continuously. If the indicator lamp is lit, the occupant classification system (OCS) has disabled the co-driver's airbag. • The display must not show the messages Front Passenger Airbag Enabled or Front Passenger Airbag Disabled. ► Wait for at least one minute until the necessary system checks have been completed. ► Ensure that the display does not show either of the two display messages about the co-driver's airbag. <p>If these conditions are met, the front passenger seat can be occupied again. Observe the notes on the occupant classification system (OCS) (→ page 30).</p> <p>If these conditions are not met, the automatic co-driver's airbag actuation is malfunctioning.</p> <ul style="list-style-type: none"> ► Install the child restraint system on a suitable rear seat. <p>or</p> <ul style="list-style-type: none"> ► Seat a person of smaller stature on a suitable rear seat. ► Consult a qualified specialist workshop immediately. <p>Further information on airbag shutoff can be found under "Occupant classification system (OCS)" (→ page 30).</p>
<p>Front Passenger Airbag Enabled See Operator's Manual</p>	<p>* The co-driver's airbag is enabled while the vehicle is in motion although:</p> <ul style="list-style-type: none"> • the front passenger seat is occupied by a child in a child restraint system or a person of smaller stature. <p>or</p> <ul style="list-style-type: none"> • the front passenger seat is not occupied. <p>The system may detect objects or forces that are adding to the weight applied to the seat.</p>

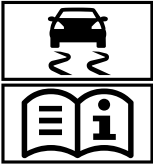









Display messages	Possible causes/consequences and ► Solutions
	<p data-bbox="502 265 1123 347"> ▲ WARNING Risk of injury or death when using a rearward-facing child restraint system while the front passenger air-bag is enabled </p> <p data-bbox="502 354 1123 455"> If you secure a child in a rearward-facing child restraint system on the front passenger seat and the PASSENGER AIR BAG OFF indicator lamp is off, the front passenger airbag can deploy in the event of an accident. </p> <p data-bbox="502 462 1123 491"> The child could be struck by the airbag. </p> <p data-bbox="502 498 1123 548"> Always ensure that the front passenger airbag is disabled. The PASSENGER AIR BAG OFF indicator lamp must be lit. </p> <p data-bbox="502 555 1123 634"> NEVER use a rearward-facing child restraint system on a seat with an ENABLED FRONT AIRBAG. This can result in the DEATH of or SERIOUS INJURY to the CHILD. </p> <ul style="list-style-type: none"> <li data-bbox="502 655 1123 706">► Stop the vehicle immediately in accordance with the traffic conditions. <li data-bbox="502 713 1123 741">► Secure the vehicle against rolling away. <li data-bbox="502 749 1123 799">► Ensure that no objects have become trapped beneath the front passenger seat. <li data-bbox="502 806 1123 835">► Switch off the ignition. <li data-bbox="502 842 1123 870">► Open the front passenger door. <li data-bbox="502 878 1123 928">► Remove the child and the child restraint system from the front passenger seat. <li data-bbox="502 935 1123 1064">► Make sure there are no objects applying additional weight to the seat. The system may otherwise detect the additional weight and interpret the vehicle occupant's weight on the front passenger seat as greater than it actually is. <li data-bbox="502 1071 1123 1121">► Make sure that the front passenger seat is unoccupied, close the front passenger door and switch on the ignition. <li data-bbox="502 1128 1123 1179">► Observe the PASSENGER AIRBAG OFF indicator lamp on the center console and the display. <li data-bbox="502 1186 1123 1394">► With the seat unoccupied and the ignition switched on, check the following: <ul style="list-style-type: none"> <li data-bbox="542 1236 1123 1315">• The PASSENGER AIRBAG OFF indicator lamp must light up continuously. If the indicator lamp is lit, the occupant classification system (OCS) has disabled the co-driver's airbag. <li data-bbox="542 1322 1123 1394">• The display must not show the messages Front Passenger Airbag Enabled See Operator's Manual or Front Passenger Airbag Disabled See Operator's Manual. <li data-bbox="502 1401 1123 1451">► Wait for at least one minute until the necessary system checks have been completed. <li data-bbox="502 1458 1123 1508">► Ensure that the display does not show either of the two display messages about the co-driver's airbag. <p data-bbox="502 1533 1123 1609"> If these conditions are met, the front passenger seat can be occupied again. Observe the notes on the occupant classification system (OCS) (→ page 30). </p>



Display messages	Possible causes/consequences and ► Solutions
	<p>If these conditions are not met, the automatic co-driver's airbag actuation is malfunctioning.</p> <ul style="list-style-type: none"> ► Install the child restraint system on a suitable rear seat. or ► Seat a person of smaller stature on a suitable rear seat. ► Consult a qualified specialist workshop immediately. <p>Further information on airbag shutoff can be found under "Occupant classification system (OCS)" (→ page 30).</p>
 <p>(equipment-dependent) Check Brake Pad Wear</p>	<p>* The brakepads have reached their wear limit.</p> <ul style="list-style-type: none"> ► Consult a qualified specialist workshop.
 <p>(USA only)</p>  <p>(Canada only) Check Brake Fluid Level</p>	<p>* There is insufficient brake fluid in the brake fluid reservoir.</p> <div style="border: 1px solid black; padding: 5px; margin: 5px 0;"> <p>▲ WARNING Risk of an accident due to low brake fluid level</p> <p>If the brake fluid level is too low, the braking effect and the braking characteristics may be impaired.</p> <ul style="list-style-type: none"> ► Pull over and stop the vehicle safely as soon as possible, paying attention to road and traffic conditions. Do not continue driving under any circumstances. ► Consult a qualified specialist workshop. ► Do not add brake fluid. </div>
 <p>EBD, ABS, ESP Inoperative</p>	<p>* EBD is unavailable due to a malfunction. This means that ABS, BAS, hill start assist and ESP® as well as its driving safety systems, for example, are also unavailable.</p> <p>ATTENTION ASSIST is deactivated and other driving systems could be automatically deactivated.</p> <p>The brake system continues to function normally, but without the functions listed above.</p> <div style="border: 1px solid black; padding: 5px; margin: 5px 0;"> <p>▲ WARNING Risk of skidding if EBD, ABS and ESP® are malfunctioning</p> <p>The wheels may block during braking and ESP® does not perform any vehicle stabilization.</p> <p>The steerability and braking characteristics are heavily impaired and the braking distance may increase. In addition, other driving safety systems are switched off.</p> <ul style="list-style-type: none"> ► Drive on carefully. ► Have the brake system checked immediately at a qualified specialist workshop. </div> <ul style="list-style-type: none"> ► Switch the engine off, wait briefly and start the engine again.

Display messages	Possible causes/consequences and ► Solutions
	<ul style="list-style-type: none"> ► Check whether the display message has disappeared and ESP® is operational. <p>If the display message continues to be shown:</p> <ul style="list-style-type: none"> ► Drive on carefully. ► Consult a qualified specialist workshop immediately.
<div style="border: 1px solid black; padding: 5px; margin-bottom: 5px; text-align: center;"> EBD </div> <div style="border: 1px solid black; padding: 5px; margin-bottom: 5px; text-align: center;"> ABS </div> <div style="border: 1px solid black; padding: 5px; text-align: center;">  </div> <p>Inoperative See Operator's Manual</p>	<p>* EBD is unavailable due to a malfunction. This means that ABS, BAS, hill start assist and ESP® as well as its driving safety systems, for example, are also unavailable.</p> <p>ATTENTION ASSIST is deactivated and other driving systems could be automatically deactivated.</p> <p>The brake system continues to function normally, but without the functions listed above.</p> <div style="border: 1px solid gray; padding: 5px; margin-top: 10px;"> <p>▲ WARNING Risk of skidding if EBD, ABS and ESP® are malfunctioning</p> <p>The wheels may block during braking and ESP® does not perform any vehicle stabilization.</p> <p>The steerability and braking characteristics are heavily impaired and the braking distance may increase. In addition, other driving safety systems are switched off.</p> <ul style="list-style-type: none"> ► Drive on carefully. ► Have the brake system checked immediately at a qualified specialist workshop. </div>
<div style="border: 1px solid black; padding: 5px; margin-bottom: 5px; text-align: center;">  </div> <div style="border: 1px solid black; padding: 5px; text-align: center;">  </div> <p>Inoperative</p>	<p>* ESP®, BAS and hill start assist are unavailable due to a malfunction. ATTENTION ASSIST is deactivated and other driving systems could be automatically deactivated.</p> <p>The brake system continues to function normally, but without the functions listed above. The wheels could therefore lock up at an early stage if you brake hard, for example.</p> <p>This will severely impair steerability and braking. Braking distance may increase in an emergency braking situation.</p> <div style="border: 1px solid gray; padding: 5px; margin-top: 10px;"> <p>▲ WARNING Risk of skidding if ESP® is malfunctioning</p> <p>If ESP® is malfunctioning, ESP® cannot carry out vehicle stabilization. In addition, other driving safety systems are switched off.</p> <ul style="list-style-type: none"> ► Drive on carefully. ► Have ESP® checked at a qualified specialist workshop. </div> <ul style="list-style-type: none"> ► Switch the engine off, wait briefly and start the engine again. ► Check whether the display message has disappeared and ESP® is operational. <p>If the display message continues to be shown:</p> <ul style="list-style-type: none"> ► Drive on carefully. ► Consult a qualified specialist workshop immediately.



Display messages	Possible causes/consequences and ► Solutions
 <p data-bbox="185 351 398 399">Inoperative See Operator's Manual</p>	<p data-bbox="461 261 1100 345">* ESP®, BAS and hill start assist are unavailable due to a malfunction. ATTENTION ASSIST is deactivated and other driving systems could be automatically deactivated.</p> <p data-bbox="477 354 1089 485">The brake system continues to function normally, but without the functions listed above. The wheels could therefore lock up at an early stage in the event of maximum full-stop braking, for example. This will severely impair steerability and braking. Braking distance may increase in an emergency braking situation.</p> <div data-bbox="484 503 1102 677" style="border: 1px solid gray; padding: 5px;"> <p data-bbox="490 512 1021 539">▲ WARNING Risk of skidding if ESP® is malfunctioning</p> <p data-bbox="494 551 1087 605">If ESP® is malfunctioning, ESP® cannot carry out vehicle stabilization. In addition, other driving safety systems are switched off.</p> <ul style="list-style-type: none"> <li data-bbox="494 614 694 641">► Drive on carefully. <li data-bbox="494 646 1027 673">► Have ESP® checked at a qualified specialist workshop. </div>
 <p data-bbox="185 870 350 897">Currently Unavail.</p>	<p data-bbox="461 697 1100 754">* ESP®, BAS and hill start assist are unavailable due to a malfunction. Self-diagnosis is not yet complete, for example.</p> <p data-bbox="477 763 1089 817">ATTENTION ASSIST is deactivated and other driving systems could be automatically deactivated.</p> <p data-bbox="477 826 1089 956">The brake system continues to function normally, but without the functions listed above. The wheels could therefore lock up at an early stage in the event of maximum full-stop braking, for example. This will severely impair steerability and braking. Braking distance may increase in an emergency braking situation.</p> <div data-bbox="484 974 1102 1148" style="border: 1px solid gray; padding: 5px;"> <p data-bbox="490 983 1021 1010">▲ WARNING Risk of skidding if ESP® is malfunctioning</p> <p data-bbox="494 1023 1087 1076">If ESP® is malfunctioning, ESP® cannot carry out vehicle stabilization. In addition, other driving safety systems are switched off.</p> <ul style="list-style-type: none"> <li data-bbox="494 1085 694 1112">► Drive on carefully. <li data-bbox="494 1118 1027 1145">► Have ESP® checked at a qualified specialist workshop. </div> <ul style="list-style-type: none"> <li data-bbox="484 1171 1100 1268">► Drive carefully on a suitable stretch of road, making slight steering movements at a speed above 12 mph (20 km/h). The functions mentioned above will be available again when the display message goes out. <li data-bbox="484 1277 1069 1304">► Switch the engine off, wait briefly and start the engine again. <li data-bbox="484 1313 1093 1367">► Check whether the display message has disappeared and ESP® is operational. <p data-bbox="477 1390 902 1417">If the display message continues to be shown:</p> <ul style="list-style-type: none"> <li data-bbox="484 1426 681 1453">► Drive on carefully. <li data-bbox="484 1462 994 1489">► Consult a qualified specialist workshop immediately.

Display messages	Possible causes/consequences and ► Solutions
 <p>Currently Unavail. See Operator's Manual</p>	<p>* ESP®, BAS and hill start assist are unavailable due to a malfunction. Self-diagnosis is not yet complete, for example. ATTENTION ASSIST is deactivated and other driving systems could be automatically deactivated.</p> <p>The brake system continues to function normally, but without the functions listed above. The wheels could therefore lock up at an early stage in the event of maximum full-stop braking, for example. This will severely impair steerability and braking. Braking distance may increase in an emergency braking situation.</p> <div style="border: 1px solid gray; padding: 5px; margin: 10px 0;"> <p>▲ WARNING Risk of skidding if ESP® is malfunctioning</p> <p>If ESP® is malfunctioning, ESP® cannot carry out vehicle stabilization. In addition, other driving safety systems are switched off.</p> <ul style="list-style-type: none"> ▶ Drive on carefully. ▶ Have ESP® checked at a qualified specialist workshop. </div> <p>► Drive carefully on a suitable stretch of road, making slight steering movements at a speed above 12 mph (20 km/h). The functions mentioned above will be available again when the display message goes out.</p> <p>If the display message continues to be shown:</p> <ul style="list-style-type: none"> ► Drive on carefully. ► Consult a qualified specialist workshop immediately.
 <p>(USA only)</p>  <p>(Canada only)</p> <p>Please Release Parking Brake</p>	<p>* The red  (USA only) or  (Canada only) indicator lamp on the instrument cluster lights up.</p> <p>A warning tone also sounds.</p> <p>You are driving with the parking brake applied or performing emergency braking using the parking brake.</p> <ul style="list-style-type: none"> ► Release the parking brake (→ page 109).
 <p>Malfunction Visit Dealer</p>	<p>* The restraint system is malfunctioning. In addition, the  warning lamp on the instrument cluster lights up.</p> <div style="border: 1px solid gray; padding: 5px; margin: 10px 0;"> <p>▲ WARNING Risk of injury due to malfunctions in the restraint system</p> <p>Components in the restraint system may be activated unintentionally or not deploy as planned in an accident.</p> <ul style="list-style-type: none"> ▶ Have the restraint system checked and repaired immediately at a qualified specialist workshop. </div> <p>Further information on the restraint system and its components can be found under "Occupant safety".</p>

Display messages	Possible causes/consequences and ► Solutions
 <p>SRS Malfunction: Service Required</p>	<p>* The restraint system is malfunctioning. In addition, the  warning lamp on the instrument cluster lights up.</p> <div style="border: 1px solid gray; padding: 5px;"> <p> WARNING Risk of injury due to malfunctions in the restraint system</p> <p>Components in the restraint system may be activated unintentionally or not deploy as planned in an accident.</p> <ul style="list-style-type: none"> ► Have the restraint system checked and repaired immediately at a qualified specialist workshop. </div> <p>Further information on the restraint system and its components can be found under "Occupant safety".</p>
 <p>Fr. Left Malf. Service Req. (example)</p>	<p>* The corresponding restraint system is malfunctioning. In addition, the  warning lamp on the instrument cluster lights up.</p> <div style="border: 1px solid gray; padding: 5px;"> <p> WARNING Risk of injury due to malfunctions in the restraint system</p> <p>Components in the restraint system may be activated unintentionally or not deploy as planned in an accident.</p> <ul style="list-style-type: none"> ► Have the restraint system checked and repaired immediately at a qualified specialist workshop. </div> <p>► Consult a qualified specialist workshop immediately.</p>
 <p>Front Left Malfunction Service Required (example)</p>	<p>* The corresponding restraint system is malfunctioning. In addition, the  warning lamp on the instrument cluster lights up.</p> <div style="border: 1px solid gray; padding: 5px;"> <p> WARNING Risk of injury due to malfunctions in the restraint system</p> <p>Components in the restraint system may be activated unintentionally or not deploy as planned in an accident.</p> <ul style="list-style-type: none"> ► Have the restraint system checked and repaired immediately at a qualified specialist workshop. </div> <p>► Consult a qualified specialist workshop immediately.</p>
<p>Left Curtain Airbag Service Required (example)</p>	<p>* The corresponding window curtain airbag is malfunctioning. In addition, the  warning lamp on the instrument cluster lights up.</p> <div style="border: 1px solid gray; padding: 5px;"> <p> WARNING Risk of injury or fatal injury due to a malfunction in the window curtain airbag</p> <p>The window curtain airbag might be triggered unintentionally or might not be triggered at all in the event of an accident.</p> <ul style="list-style-type: none"> ► Have the window curtain airbag checked and repaired immediately at a qualified specialist workshop. </div> <p>► Consult a qualified specialist workshop immediately.</p>

Display messages	Possible causes/consequences and ► Solutions
 <p data-bbox="207 347 429 422">Left Curtain Airbag Malfunction: Service Required (example)</p>	<p data-bbox="484 258 1121 308">* The corresponding window curtain airbag is malfunctioning. In addition, the  warning lamp on the instrument cluster lights up.</p> <div data-bbox="505 326 1126 387" style="border: 1px solid black; padding: 5px;"> <p data-bbox="513 333 1110 383">▲ WARNING Risk of injury or fatal injury due to a malfunction in the window curtain airbag</p> </div> <p data-bbox="518 397 1102 448">The window curtain airbag might be triggered unintentionally or might not be triggered at all in the event of an accident.</p> <ul data-bbox="518 455 1044 505" style="list-style-type: none"> ▶ Have the window curtain airbag checked and repaired immediately at a qualified specialist workshop. <p data-bbox="502 530 1015 555">► Consult a qualified specialist workshop immediately.</p>

Driving systems

Display messages	Possible causes/consequences and ► Solutions
<p data-bbox="207 691 426 741">120 km/h or Maximum Speed 120 km/h</p>	<p data-bbox="484 691 1084 741">* For certain countries only: the maximum permissible speed has been exceeded.</p> <p data-bbox="502 749 702 774">► Drive more slowly.</p>
<p data-bbox="207 792 402 842">120 km/h Maximum Speed Exceeded</p>	<p data-bbox="484 792 1084 842">* For certain countries only: the maximum permissible speed has been exceeded.</p> <p data-bbox="502 849 702 874">► Drive more slowly.</p>
 <p data-bbox="207 978 426 1003">Attent. Asst Inoperative</p>	<p data-bbox="484 892 781 917">* ATTENTION ASSIST has failed.</p> <p data-bbox="502 924 900 949">► Consult a qualified specialist workshop.</p>
 <p data-bbox="207 1114 439 1164">Attention Assist Inoperative</p>	<p data-bbox="484 1028 781 1053">* ATTENTION ASSIST has failed.</p> <p data-bbox="502 1060 900 1085">► Consult a qualified specialist workshop.</p>
 <p data-bbox="207 1279 431 1304">Attent. Asst Take Break!</p>	<p data-bbox="484 1193 1110 1243">* Based on certain criteria, ATTENTION ASSIST has detected fatigue or increasing lapses in concentration on the part of the driver. A warning tone also sounds.</p> <p data-bbox="502 1279 781 1304">► If necessary, take a break.</p> <p data-bbox="502 1322 1102 1372">On long journeys, take regular and timely breaks that allow you to rest properly.</p>
<p data-bbox="207 1387 386 1437">Attent. Asst Take a Break!</p>	<p data-bbox="484 1387 1110 1437">* Based on certain criteria, ATTENTION ASSIST has detected fatigue or increasing lapses in concentration on the part of the driver. A warning tone also sounds.</p> <p data-bbox="502 1473 781 1498">► If necessary, take a break.</p> <p data-bbox="502 1516 1102 1566">On long journeys, take regular and timely breaks that allow you to rest properly.</p>

Display messages	Possible causes/consequences and ► Solutions
Active Distance Assist --- mph	* An activation condition for Active Distance Assist DISTRONIC has not been fulfilled. ► Comply with the activation conditions for Active Distance Assist DISTRONIC (→ page 116).
Active Distance Assist Off	* Active Distance Assist DISTRONIC has been deactivated (→ page 116). In the event of a deactivation not initiated by the driver, a warning tone sounds as well.
Active Distance Assist Inoperative	* A warning tone also sounds. Active Distance Assist DISTRONIC is malfunctioning. In addition, BAS may have failed. ► Consult a qualified specialist workshop.
Active Distance Assist and Limiter Inoperative	* A warning tone also sounds. Active Distance Assist DISTRONIC and the limiter are malfunctioning. ► Consult a qualified specialist workshop.
Act. Distance Assist Sus- pended	* You are accelerating. Active Distance Assist DISTRONIC does not intervene for the duration of the acceleration process. ► Remove your foot from the accelerator pedal. Active Distance Assist DISTRONIC will be activated again.
Active Distance Assist Curr. Unavailable See Oper. Manual	* A warning tone also sounds. Active Distance Assist DISTRONIC has been switched off and is temporarily non-operational. The following causes are possible: <ul style="list-style-type: none"> • The function is impaired due to heavy rain or snow. • The radar sensor system is temporarily non-operational, e.g. due to electromagnetic radiation close to TV or radio transmitting stations or other sources of radiation. • The system is outside the operating temperature range. • The on-board electrical system voltage is too low. If the causes mentioned above no longer apply, the display message will disappear and Active Distance Assist DISTRONIC will be operational again. If the display message does not disappear: <ul style="list-style-type: none"> ► Stop in accordance with the traffic conditions. ► Secure the vehicle against rolling away.
Active Brake Assist Sys- tem Inoperative	* Active Brake Assist is unavailable due to a malfunction. ► Consult a qualified specialist workshop.
Active Brake Assist Cur- rently Unavail.	* Active Brake Assist is temporarily non-operational. The following causes are possible: <ul style="list-style-type: none"> • The sensors in the front bumper are dirty. • The function is impaired due to heavy rain or snow. • The radar sensor system is temporarily non-operational, e.g. due to electromagnetic radiation close to TV or radio transmitting stations or other sources of radiation.



Display messages	Possible causes/consequences and ► Solutions
	<ul style="list-style-type: none"> • The system is outside the operating temperature range. • The on-board electrical system voltage is too low. <p>If the causes mentioned above no longer apply, the display message will disappear and Active Brake Assist will be operational again.</p> <p>If the display message does not disappear:</p> <ul style="list-style-type: none"> ► Stop in accordance with the traffic conditions. ► Secure the vehicle against rolling away. ► Switch off the engine. ► Clean the sensors in the front bumper (→ page 184). ► Restart the engine.
Active Distance Assist Now Available	<p>* Active Distance Assist DISTRONIC is operational again following temporary non-availability. You can now switch Active Distance Assist DISTRONIC on again (→ page 117, 119).</p>
Cruise Control --- mph	<p>* An activation condition for cruise control has not been met.</p> <p>For example, you are aiming to store a speed below 20 mph (30 km/h).</p> <ul style="list-style-type: none"> ► If conditions permit, drive at a speed greater than 20 mph (30 km/h) and store the speed. ► Observe the activation conditions for cruise control (→ page 115).
Cruise Control and Limiter Inoperative	<p>* A warning tone also sounds. Cruise control and the limiter are malfunctioning.</p> <ul style="list-style-type: none"> ► Visit a qualified specialist workshop.
Blind Spot Assist Inoperative	<p>* Blind Spot Assist is malfunctioning.</p> <ul style="list-style-type: none"> ► Consult a qualified specialist workshop.
Blind Spot Assist Currently Unavail. See Operator's Manual	<p>* Blind Spot Assist is temporarily non-operational.</p> <p>The following causes are possible:</p> <ul style="list-style-type: none"> • You have coupled up a trailer. • The sensors in the rear bumper are dirty. • The function is impaired due to heavy rain or snow. • The radar sensor system is temporarily non-operational, e.g. due to electromagnetic radiation close to TV or radio transmitting stations or other sources of radiation. • The system is outside the operating temperature range. <p>If the causes mentioned above no longer apply, the display message will disappear and Lane Keeping Assist will be operational again.</p> <p>If the display message does not disappear:</p> <ul style="list-style-type: none"> ► Stop in accordance with the traffic conditions. ► Secure the vehicle against rolling away. ► Switch off the engine. ► Clean the sensors in the rear bumper (→ page 184). ► Restart the engine.



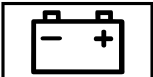

Display messages	Possible causes/consequences and ► Solutions
Park Assist Canceled	<p>* An acoustic signal sounds as well. The active parking assistance systems have been canceled and Active Parking Assist will automatically be aborted. You have touched the steering wheel, for example, or have driven at too high a speed.</p> <ul style="list-style-type: none"> ► Steer and brake manually. ► Repeat the parking procedure if necessary. Comply with the deactivation conditions (→ page 125).
Park Assist Inoperative	<p>* PARKTRONIC is malfunctioning or defective.</p> <ul style="list-style-type: none"> ► Comply with the instructions and aids in "Function of PARKTRONIC"(→ page 122). ► If the display message continues to be displayed, consult a qualified specialist workshop: <p>* Active Parking Assist is not available or is malfunctioning.</p> <ul style="list-style-type: none"> ► Switch off the ignition. ► Restart the engine. <p>If the display message continues to be displayed, or if the display does not show the P symbol:</p> <ul style="list-style-type: none"> ► Consult a qualified specialist workshop.
Lane Keeping Assist Inoperative	<p>* Lane Keeping Assist is malfunctioning.</p> <ul style="list-style-type: none"> ► Consult a qualified specialist workshop.
Lane Keeping Assist Currently Unavail. See Oper. Manual	<p>* Lane Keeping Assist has been switched off and is temporarily non-operational.</p> <p>The following causes are possible:</p> <ul style="list-style-type: none"> • The windshield is dirty in the camera's field of vision. • Visibility is impaired due to heavy rain, snow or fog. • Lane markings are absent for a long period of time. • The lane markings are worn, dark or covered by dirt or snow, for example. <p>If the causes mentioned above no longer apply, the display message will disappear and Lane Keeping Assist will be operational again.</p> <p>If the display message does not disappear:</p> <ul style="list-style-type: none"> ► Stop in accordance with the traffic conditions. ► Secure the vehicle against rolling away. ► Clean the windshield.





Engine

Display messages	Possible causes/consequences and ► Solutions
	<p>* A warning tone also sounds.</p>

Display messages	Possible causes/consequences and ► Solutions
	<p>The battery is no longer being charged for one of the following reasons:</p> <ul style="list-style-type: none"> • Faulty alternator • Torn poly-V belt • Malfunction in the electronics <p>► Stop immediately in accordance with the traffic conditions and switch off the engine. Do not continue driving. If you do, the engine may overheat.</p> <p>► Secure the vehicle against rolling away.</p> <p>► Consult a qualified specialist workshop.</p>
 <p>Stop Vehicle Turn Eng. Off</p>	<p>* A warning tone also sounds. The coolant is too hot.</p> <p>► Stop immediately in accordance with the traffic conditions and switch off the engine.</p> <div style="border: 1px solid gray; padding: 5px; margin: 5px 0;"> <p>▲ WARNING Risk of burns when opening the hood</p> <p>If you open the hood when the engine has overheated or when there is a fire in the engine compartment, the following situations may occur:</p> <ul style="list-style-type: none"> • You could come into contact with hot gases. • You could come into contact with other hot, escaping operating fluids. <p>► Before opening the hood, allow the overheated engine to cool down.</p> <p>► In the event of a fire in the engine compartment, keep the hood closed and call the fire service.</p> </div> <div style="border: 1px solid gray; padding: 5px; margin: 5px 0;"> <p>▲ WARNING Risk of scalding from hot coolant</p> <p>If you open the cap, you could be scalded.</p> <ul style="list-style-type: none"> ► Let the motor cool down before opening the cap. ► When opening the cap, wear protective gloves and safety glasses. ► Open the cap slowly to release pressure. </div> <p>► Observe the coolant temperature display (→ page 142).</p> <p>► Wait until the engine has cooled down.</p> <p>► Ensure that the air supply to the radiator is not obstructed.</p> <p>► Avoiding high engine loads, drive on to the nearest qualified specialist workshop. In doing so, ensure that the coolant temperature display remains below the letter H.</p>

Display messages	Possible causes/consequences and ► Solutions
<div data-bbox="194 265 346 345" data-label="Image"> </div> <p data-bbox="185 351 389 422">Coolant Too Hot: Stop Vehicle Switch Engine Off</p>	<p data-bbox="461 261 944 284">* A warning tone also sounds. The coolant is too hot.</p> <div data-bbox="484 301 1102 342" data-label="Section-Header"> <p>▲ WARNING Risk of burns when opening the hood</p> </div> <p data-bbox="494 347 1067 426">If you open the hood when the engine has overheated or when there is a fire in the engine compartment, the following situations may occur:</p> <ul data-bbox="504 435 1071 641" style="list-style-type: none"> • You could come into contact with hot gases. • You could come into contact with other hot, escaping operating fluids. ► Before opening the hood, allow the overheated engine to cool down. ► In the event of a fire in the engine compartment, keep the hood closed and call the fire service. <div data-bbox="484 672 1102 713" data-label="Section-Header"> <p>▲ WARNING Risk of scalding from hot coolant</p> </div> <p data-bbox="494 718 879 741">If you open the cap, you could be scalded.</p> <ul data-bbox="504 750 1052 865" style="list-style-type: none"> ► Let the motor cool down before opening the cap. ► When opening the cap, wear protective gloves and safety glasses. ► Open the cap slowly to release pressure. <ul data-bbox="484 892 1102 1148" style="list-style-type: none"> ► Stop immediately in accordance with the traffic conditions and switch off the engine. ► Monitor the coolant temperature display  on the instrument cluster. ► Wait until the engine has cooled down. ► Ensure that the air supply to the radiator is not obstructed. ► Avoiding high engine loads, drive on to the nearest qualified specialist workshop. In doing so, ensure that the coolant temperature display remains below the red marking.
<div data-bbox="194 1166 346 1247" data-label="Image"> </div>	<p data-bbox="461 1163 721 1186">* The fan motor is defective.</p> <p data-bbox="477 1195 850 1218">Vehicles without steering-wheel buttons:</p> <ul data-bbox="484 1227 939 1256" style="list-style-type: none"> ► Check the coolant temperature (→ page 142). <p data-bbox="477 1277 821 1300">Vehicles with steering-wheel buttons:</p> <ul data-bbox="484 1309 1093 1358" style="list-style-type: none"> ► Check the coolant temperature display  on the instrument cluster. <p data-bbox="477 1378 1076 1449">If the coolant temperature is below the maximum value specified below, you can continue driving to the nearest qualified specialist workshop.</p> <p data-bbox="477 1458 1073 1507">Avoid high engine loads, e.g. driving on hilly roads or stop-and-go driving.</p> <p data-bbox="477 1516 1097 1564">During normal driving and if the coolant level is correct, the coolant temperature display is permitted to rise to letter H.</p>

Display messages	Possible causes/consequences and ► Solutions
 <p data-bbox="207 347 397 372">Check Coolant Level</p>	<p data-bbox="484 258 755 283">* The coolant level is too low.</p> <div data-bbox="505 297 1123 383" style="border: 1px solid black; padding: 5px;"> <p data-bbox="513 304 1008 333">! NOTE Engine damage due to insufficient coolant</p> <p data-bbox="513 344 963 372">► Avoid long journeys with insufficient coolant.</p> </div> <p data-bbox="500 394 1073 422">► Add coolant, following the notes on coolant (→ page 180).</p> <p data-bbox="500 444 844 473">If you frequently need to add coolant:</p> <p data-bbox="500 476 1123 526">► Have the engine cooling system checked at a qualified specialist workshop.</p>
 <p data-bbox="207 634 439 684">Check Coolant Level See Oper. Manual</p>	<p data-bbox="484 544 755 569">* The coolant level is too low.</p> <div data-bbox="505 584 1123 670" style="border: 1px solid black; padding: 5px;"> <p data-bbox="513 591 1008 620">! NOTE Engine damage due to insufficient coolant</p> <p data-bbox="513 630 963 659">► Avoid long journeys with insufficient coolant.</p> </div> <p data-bbox="500 680 1073 709">► Add coolant, following the notes on coolant (→ page 180).</p> <p data-bbox="500 731 844 759">If you frequently need to add coolant:</p> <p data-bbox="500 763 1123 813">► Have the engine cooling system checked at a qualified specialist workshop.</p>
 <p data-bbox="207 921 418 996">Check Engine Oil Level or Check Engine Oil At Next Refueling</p>	<p data-bbox="484 831 1123 881">* A warning tone also sounds. The oil level in your vehicle has fallen to the minimum.</p> <div data-bbox="505 896 1123 999" style="border: 1px solid black; padding: 5px;"> <p data-bbox="513 903 1079 953">! NOTE Engine damage caused by driving with insufficient engine oil</p> <p data-bbox="513 964 984 992">► Avoid long journeys with insufficient engine oil.</p> </div> <p data-bbox="500 1014 1010 1071">► Check the oil level when next refueling, at the latest (→ page 179).</p> <p data-bbox="500 1075 926 1103">► If necessary, add engine oil (→ page 179).</p> <p data-bbox="500 1125 926 1154">If engine oil frequently needs to be topped up:</p> <p data-bbox="500 1157 1081 1186">► Have the engine checked at a qualified specialist workshop.</p>
<p data-bbox="207 1200 439 1225">Manually Check Oil Level</p>	<p data-bbox="484 1200 789 1225">* Reminder to check the oil level.</p> <div data-bbox="505 1240 1123 1344" style="border: 1px solid black; padding: 5px;"> <p data-bbox="513 1247 1079 1297">! NOTE Engine damage caused by driving with insufficient engine oil</p> <p data-bbox="513 1308 984 1336">► Avoid long journeys with insufficient engine oil.</p> </div> <p data-bbox="500 1361 1010 1419">► Check the oil level when next refueling, at the latest (→ page 179).</p> <p data-bbox="500 1422 926 1451">► If necessary, add engine oil (→ page 179).</p> <p data-bbox="500 1455 1108 1483">► To confirm the oil level check: press and hold the (R) button.</p>
 <p data-bbox="207 1587 439 1612">Manually Check Oil Level</p>	<p data-bbox="484 1498 789 1523">* Reminder to check the oil level.</p>

Display messages	Possible causes/consequences and ► Solutions
	<p>! NOTE Engine damage caused by driving with insufficient engine oil</p> <p>► Avoid long journeys with insufficient engine oil.</p> <p>► Check the oil level when next refueling, at the latest (→ page 179).</p> <p>► If necessary, add engine oil (→ page 179).</p> <p>► To confirm the oil level: press the <input type="button" value="OK"/> button.</p>
 <p>Stop Vehicle Turn Eng. Off</p>	<p>* The oil level is too low. There is a risk of engine damage.</p> <p>► Stop immediately in accordance with the traffic conditions and switch off the engine.</p> <p>► Secure the vehicle against rolling away.</p> <p>► Check the oil level (→ page 179).</p> <p>► If necessary, add engine oil (→ page 179).</p>
 <p>Eng. Oil Level Low: Stop Vehicle Switch Engine Off</p>	<p>* The oil level is too low. There is a risk of engine damage.</p> <p>► Stop immediately in accordance with the traffic conditions and switch off the engine.</p> <p>► Secure the vehicle against rolling away.</p> <p>► Check the oil level (→ page 179).</p> <p>► If necessary, add engine oil (→ page 179).</p>
 <p>Fuel Level Low</p>	<p>* The fuel supply has dropped into the reserve range.</p> <p>► Refuel the vehicle.</p>
	<p>* There is very little fuel in the fuel tank.</p> <p>► It is absolutely essential to refuel at the nearest gas station.</p>

Tires

Display messages	Possible causes/consequences and ► Solutions
<p>Please Correct Tire Pressure</p>	<p>* The tire pressure is too low in at least one of the tires, or the difference in tire pressure between the individual wheels is too great.</p> <p>► Check the tire pressure at the next opportunity .</p> <p>► Correct the tire pressure as necessary.</p> <p>► Restart the tire pressure monitoring system (→ page 209).</p>
<p>Check Tires</p>	<p>* A warning tone also sounds.</p> <p>The tire pressure in one or more tires has dropped significantly.</p>





Display messages	Possible causes/consequences and ► Solutions
	<p>▲ WARNING Risk of an accident due to insufficient tire pressure</p> <ul style="list-style-type: none"> • The tires can burst. • The tires can wear excessively and/or unevenly. • The driving characteristics as well as the steering and braking may be greatly impaired. <p>You could then lose control of the vehicle.</p> <ul style="list-style-type: none"> ► Observe the recommended tire pressures. ► Adjust the tire pressure if necessary. <ul style="list-style-type: none"> ► Stop the vehicle without steering or braking suddenly. Pay attention to the traffic conditions. ► Secure the vehicle against rolling away. ► Check the tires. If necessary, replace the wheel (→ page 218). ► Check the tire pressure. Correct the tire pressure as necessary .
Warning Tire Malfunction	<p>* The tire pressure in one or more tires has dropped suddenly.</p> <p>▲ WARNING Risk of an accident from driving with a flat tire</p> <ul style="list-style-type: none"> • The tires can overheat and cause a fire. • The driving characteristics as well as the steering and braking may be greatly impaired. <p>You could then lose control of the vehicle.</p> <ul style="list-style-type: none"> ► Do not drive on with a flat tire. ► Observe the notes on flat tires. <ul style="list-style-type: none"> ► Stop the vehicle without steering or braking suddenly. Pay attention to the traffic conditions. ► Secure the vehicle against rolling away. ► Check the tires. If necessary, replace the wheel (→ page 218).
Tire Press. Monitor Currently Unavail.	<p>* Due to a source of radio interference, no signals from the tire pressure sensors are being received. The tire pressure monitoring system is temporarily malfunctioning.</p> <p>The tire pressure monitoring system restarts automatically as soon as the cause has been rectified.</p>
Wheel Sensor(s) Missing	<p>* There is no signal from the tire pressure sensor of at least one tire. The display is not showing any pressure value for the tire in question.</p> <ul style="list-style-type: none"> ► Have the faulty tire pressure sensor replaced at a qualified specialist workshop.
Tire Pressure Monitor Inoperative No Wheel Sensors	<p>* The wheels installed do not have suitable tire pressure sensors. The tire pressure monitoring system is deactivated.</p> <ul style="list-style-type: none"> ► Equip wheels with suitable tire pressure sensors. The tire pressure monitoring system switches on after a few minutes of driving.





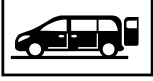

Display messages	Possible causes/consequences and ► Solutions
Tire Press. Monitor Inoperative	<p>* The tire pressure monitoring system is malfunctioning and switched off. Either the wheels installed do not have suitable tire pressure sensors or the system is malfunctioning, e.g. because a tire pressure sensor is faulty.</p> <p>► Equip wheels with suitable tire pressure sensors. The tire pressure monitoring system switches on after a few minutes of driving.</p> <p>or</p> <p>► Consult a qualified specialist workshop.</p>
Tire Pressure Monitor Inoperative	<p>* The tire pressure monitoring system is malfunctioning.</p> <p>► Consult a qualified specialist workshop.</p>

Key

Display messages	Possible causes/consequences and ► Solutions
 <p>Obtain a New Key</p>	<p>* The key needs to be replaced.</p> <p>► Visit a qualified specialist workshop.</p>





Vehicle

Display messages	Possible causes/consequences and ► Solutions
 <p>Tracking Active or Tracking not Active</p>	<p>* The Vehicle Tracker has been activated or deactivated depending on the display message.</p> <p>If the display shows the message Tracking Active:</p> <p>The vehicle has activated services from Mercedes PRO at its disposal.</p> <p>Locating the vehicle may be possible within the framework of Mercedes PRO connect.</p> <p>► Check the status of the activated services at https://mercedes.pro.</p> <p>► Ask the vehicle owner for the details.</p>
	<p>* The tailgate is open.</p> <p>► Close the tailgate.</p>
	<p>* The rear-end door is open.</p> <p>► Close the rear-end door(s).</p>
	<p>* A warning tone also sounds. The hood is open.</p>

Display messages	Possible causes/consequences and ► Solutions
	<p>▲ WARNING Risk of accident due to driving with the hood unlocked</p> <p>The hood may open and block your view.</p> <ul style="list-style-type: none"> ▶ Never release the hood when driving. ▶ Before every trip, ensure that the hood is locked. <ul style="list-style-type: none"> ▶ Stop the vehicle immediately in accordance with the traffic conditions. ▶ Secure the vehicle against rolling away. ▶ Close the hood.
 or 	<p>* In addition, a warning tone sounds during the trip. The display shows the open door or doors.</p> <ul style="list-style-type: none"> ▶ Close all the doors.
 Check Washer Fluid	<p>* The washer fluid level in the washer fluid reservoir has dropped below the minimum.</p> <ul style="list-style-type: none"> ▶ Add washer fluid (→ page 181).
  Pwr. Steering Malfunc.	<p>* A warning tone also sounds. The steering power assistance could be malfunctioning. You may need to steer more forcefully.</p> <ul style="list-style-type: none"> ▶ Carefully continue to a qualified specialist workshop and have the steering checked immediately.
 Power Steering Malfunction See Oper. Manual	<p>* A warning tone also sounds. The power assistance for the steering could be malfunctioning. You may need to steer more forcefully.</p> <ul style="list-style-type: none"> ▶ Carefully continue to a qualified specialist workshop and have the steering checked immediately.
Phone No Service	<p>* Your vehicle is outside the transmission and receiver range of the mobile phone network provider.</p>
Shift to 'P' or 'N' to Start Engine	<p>* You have attempted to start the engine in transmission position R or D.</p> <ul style="list-style-type: none"> ▶ Shift the transmission to position P or N.
Auxiliary Battery Malfunction	<p>* The auxiliary battery for the transmission is no longer being charged.</p> <ul style="list-style-type: none"> ▶ Consult a qualified specialist workshop.

Display messages	Possible causes/consequences and ► Solutions
Apply Brake to Shift from 'P'	* You have tried to shift the transmission to position [D] , [R] or [N] without applying the brake. ► Depress the brake pedal.
To Engage R First Depress Brake	* You have tried to shift the transmission to position [R] without applying the brake. ► Depress the brake pedal. ► Select transmission position [R] .
Permanent N Activated Risk of Rolling	* A warning tone also sounds. While the vehicle is rolling or driving, the transmission was shifted to position [N] . ► To stop, depress the brake pedal and, when the vehicle is at a standstill, shift the transmission to position [P] . ► To continue your journey, shift the transmission to position [R] or [D] .
Risk Of Rolling Driver's Door Open And Transmission Not In P	* A warning tone also sounds. The driver's door is open and the transmission is in position [N] , [R] or [D] . ► Shift the transmission to position [P] . ► Secure the vehicle against rolling away.
Do Not Shift Gears Service Required	* A warning tone also sounds. You can no longer change the transmission position due to a malfunction. If transmission position [D] has been selected: ► Without changing the transmission position, consult a qualified specialist workshop. If transmission position [P] , [R] or [N] has been selected: ► Inform a qualified specialist workshop.
Reversing Not Possible: Service Required	* The transmission is malfunctioning. Transmission position [R] cannot be selected. ► Inform a qualified specialist workshop.
Transmission Malfunction: Stop	* The transmission is malfunctioning. The transmission automatically switches to neutral [N] . ► Stop the vehicle immediately in accordance with the traffic conditions. ► Shift the transmission to position [P] . ► Inform a qualified specialist workshop.
Only Shift to 'P' when Vehicle is Stationary	* The vehicle is still moving. ► Stop in accordance with the traffic conditions. ► Shift the transmission to position [P] .

Lights





Display messages	Possible causes/consequences and ► Solutions
 <p data-bbox="207 390 356 440">Check Left Low Beam (example)</p>	<p data-bbox="484 301 900 324">* The corresponding light source is defective.</p> <p data-bbox="501 333 1093 383">Have defective LED lights replaced at a qualified specialist workshop.</p> <ul style="list-style-type: none"> <li data-bbox="501 390 1014 413">► Observe the notes on changing a bulb (→ page 80). <li data-bbox="501 422 1047 473">► Replace the faulty bulb at the front (→ page 81) or rear (→ page 83).
 <p data-bbox="207 578 426 602">Auto Lamps Inoperative</p>	<p data-bbox="484 489 1110 539">* The light sensor is faulty. The automatic driving lights are malfunctioning.</p> <ul style="list-style-type: none"> <li data-bbox="501 546 1054 569">► Switch the light functions on/off manually (→ page 77). <li data-bbox="501 578 900 602">► Consult a qualified specialist workshop.
 <p data-bbox="207 716 396 766">Auto Lamp Function Inoperative</p>	<p data-bbox="484 627 1110 677">* The light sensor is faulty. The automatic driving lights are malfunctioning.</p> <ul style="list-style-type: none"> <li data-bbox="501 684 1054 707">► Switch the light functions on/off manually (→ page 77). <li data-bbox="501 716 900 740">► Consult a qualified specialist workshop.
 <p data-bbox="207 879 426 930">Malfunction See Operator's Manual</p>	<p data-bbox="484 790 852 813">* The exterior lighting is malfunctioning.</p> <ul style="list-style-type: none"> <li data-bbox="501 820 900 844">► Consult a qualified specialist workshop. <p data-bbox="484 852 935 876">* Vehicles with trailer hitch: a fuse may be faulty.</p> <div data-bbox="501 892 1126 1001" style="border: 1px solid black; padding: 5px;"> <p data-bbox="514 899 760 922">! NOTE Electrical fuses</p> <ul style="list-style-type: none"> <li data-bbox="514 939 1076 989">► Observe the information in the supplement. You may otherwise fail to recognize dangers. </div> <ul style="list-style-type: none"> <li data-bbox="501 1016 1122 1066">► Check the fuses and replace any blown fuses (see "Fuse assignment" supplement). <p data-bbox="501 1091 918 1114">If the display continues to show the message:</p> <ul style="list-style-type: none"> <li data-bbox="501 1123 900 1146">► Consult a qualified specialist workshop.



Indicator and warning lamps



Indicator and warning lamps on the instrument cluster

Some systems will perform a self-test when the ignition is switched on. Some indicator and warning lamps may briefly light up or flash. This behavior is non-critical. These indicator and warning lamps indicate a malfunction only if they light up or flash after the engine has been started or during a journey.

Safety systems



Warning/indicator lamp	Possible causes/consequences and ► Solutions
 <p>Restraint system warning lamp</p>	<p>*The red warning lamp for the restraint system is on while the engine is running. The restraint system is malfunctioning.</p> <p>▲ WARNING Risk of injury due to malfunctions in the restraint system</p> <p>Components in the restraint system may be activated unintentionally or not deploy as planned in an accident.</p> <ul style="list-style-type: none"> ► Have the restraint system checked and repaired immediately at a qualified specialist workshop. <ul style="list-style-type: none"> ► Pay attention to the display messages. ► Drive on carefully. ► Have the restraint system and its components checked by a qualified specialist workshop immediately. <p>Further information on the restraint system and its components can be found under "Occupant safety".</p>
 <p>Brake system warning lamp</p>  <p>Brake system warning lamp</p>  <p>ABS warning lamp</p>	<p>*BRAKE (USA only) or  (Canada only): The ABS and brake warning lamps are on while the engine is running. EBD is not available due to a malfunction. As a result, BAS, hill start assist and ESP® as well as their driving safety systems are not available.</p> <p>ATTENTION ASSIST has been deactivated and additional driving systems may have been switched off automatically.</p> <p>▲ WARNING Risk of skidding if EBD, ABS and ESP® are malfunctioning</p> <p>The wheels may block during braking and ESP® does not perform any vehicle stabilization. The steerability and braking characteristics are heavily impaired and the braking distance may increase. In addition, other driving safety systems are switched off.</p> <ul style="list-style-type: none"> ► Drive on carefully. ► Have the brake system checked immediately at a qualified specialist workshop. <ul style="list-style-type: none"> ► Switch off the engine, wait a while and restart the engine. ► Check whether the display message has disappeared and ESP® is operational. <p>If the display message continues to be displayed:</p> <ul style="list-style-type: none"> ► Drive on carefully. ► Consult a qualified specialist workshop immediately.

Warning/indicator lamp	Possible causes/consequences and ► Solutions
<div data-bbox="217 288 369 369" data-label="Image"> </div> <p data-bbox="207 374 413 422">Brake system warning lamp</p> <div data-bbox="217 431 369 512" data-label="Image"> </div> <p data-bbox="207 517 413 566">Brake system warning lamp</p>	<p data-bbox="479 283 1113 360">*  (USA only) or  (Canada only): The red brake warning lamp is on while the engine is running. There is insufficient brake fluid in the brake fluid reservoir.</p> <div data-bbox="488 378 1126 413" data-label="Section-Header"> <p>▲ WARNING Risk of an accident due to low brake fluid level</p> </div> <p data-bbox="501 422 1097 471">If the brake fluid level is too low, the braking effect and the braking characteristics may be impaired.</p> <ul data-bbox="501 480 1077 623" style="list-style-type: none"> ► Pull over and stop the vehicle safely as soon as possible, paying attention to road and traffic conditions. Do not continue driving under any circumstances. ► Consult a qualified specialist workshop. ► Do not add brake fluid. <p data-bbox="484 646 879 673">► Secure the vehicle against rolling away.</p>
<div data-bbox="217 695 369 775" data-label="Image"> </div> <p data-bbox="207 781 376 804">ABS warning lamp</p>	<p data-bbox="479 689 1126 790">* The yellow ABS warning lamp is on while the engine is running. ABS has been switched off due to a malfunction. As a result, BAS, hill start assist and ESP® as well as their driving safety systems have also been switched off.</p> <p data-bbox="484 799 1109 847">ATTENTION ASSIST has been deactivated and additional driving systems may have been switched off automatically.</p> <div data-bbox="488 870 1126 924" data-label="Section-Header"> <p>▲ WARNING Risk of skidding if ABS and ESP® are malfunctioning</p> </div> <p data-bbox="501 942 1104 990">The wheels may block during braking and ESP® does not perform any vehicle stabilization.</p> <p data-bbox="501 999 1093 1076">The steerability and braking characteristics are heavily impaired and the braking distance may increase. In addition, other driving safety systems are switched off.</p> <ul data-bbox="501 1085 1090 1170" style="list-style-type: none"> ► Drive on carefully. ► Have ABS and ESP® checked immediately at a qualified specialist workshop. <p data-bbox="484 1193 1122 1283">► Switch off the engine, wait a while and restart the engine. ► Check whether the display message has disappeared and ESP® is operational.</p> <p data-bbox="484 1300 935 1327">If the display message continues to be displayed:</p> <ul data-bbox="484 1336 1001 1394" style="list-style-type: none"> ► Drive on carefully. ► Consult a qualified specialist workshop immediately. <p data-bbox="484 1408 1097 1456">If the ABS control unit is defective, other systems may be available only with restrictions or may be unavailable.</p>
<div data-bbox="217 1483 369 1564" data-label="Image"> </div> <p data-bbox="207 1569 386 1593">ESP® warning lamp</p>	<p data-bbox="479 1478 1126 1555">* The yellow ESP® warning lamp flashes while the vehicle is in motion. ESP® or traction control intervenes because there is a risk of skidding or at least one wheel is spinning.</p> <p data-bbox="484 1564 958 1591">Cruise control has been automatically switched off.</p>



Warning/indicator lamp	Possible causes/consequences and ► Solutions
	<ul style="list-style-type: none"> ► When pulling away, accelerate only as much as is necessary. ► Depress the accelerator pedal less during your journey. ► Adapt your driving style to suit the road and weather conditions. ► Do not switch off ESP®. <p>In exceptional cases, it may be better to switch off ESP® (→ page 111).</p>
 <p>ESP® warning lamp</p>	<p>*The yellow ESP® warning lamp is on while the engine is running. ESP®, BAS, hill start assist, ESP® trailer stabilization and Crosswind Assist are not available due to a malfunction. ATTENTION ASSIST is deactivated and other driving systems could be automatically deactivated.</p> <div style="border: 1px solid black; padding: 5px; margin: 10px 0;"> <p>▲ WARNING Risk of skidding if ESP® is malfunctioning</p> <p>If ESP® is malfunctioning, ESP® cannot carry out vehicle stabilization. In addition, other driving safety systems are switched off.</p> <ul style="list-style-type: none"> ► Drive on carefully. ► Have ESP® checked at a qualified specialist workshop. </div> <ul style="list-style-type: none"> ► Switch the engine off, wait briefly and start the engine again. ► Check whether the display message has disappeared and ESP® is operational. <p>If the display message continues to be shown:</p> <ul style="list-style-type: none"> ► Drive on carefully. ► Consult a qualified specialist workshop immediately.
 <p>ESP® OFF warning lamp</p>	<p>*The yellow ESP® OFF warning lamp is on while the engine is running. ESP® has been switched off. ESP® trailer stabilization and Crosswind Assist have been deactivated.</p> <div style="border: 1px solid black; padding: 5px; margin: 10px 0;"> <p>▲ WARNING Risk of skidding when driving with ESP® deactivated</p> <p>ESP® does not act to stabilize the vehicle. The availability of further driving safety systems is also limited.</p> <ul style="list-style-type: none"> ► Drive on carefully. ► Deactivate ESP® only for as long as the situation requires. <p>If ESP® cannot be activated, ESP® is malfunctioning.</p> <ul style="list-style-type: none"> ► Have ESP® checked immediately at a qualified specialist workshop. </div> <ul style="list-style-type: none"> ► Switch ESP® on again. <p>In exceptional cases, it may be better to switch off ESP® (→ page 111).</p>

Warning/indicator lamp	Possible causes/consequences and ► Solutions
	<ul style="list-style-type: none"> ► Adapt your driving style to suit the road and weather conditions. <p>If ESP® cannot be switched on:</p> <ul style="list-style-type: none"> ► Drive on carefully. ► Have ESP® checked at a qualified specialist workshop.



Seat belt

Warning/indicator lamp	Possible causes/consequences and ► Solutions
 <p>Seat belt warning lamp</p>	<p>*The red seat belt warning lamp lights up or flashes after the engine has started. A warning tone may also sound. For certain countries only: The red seat belt warning lamp lights up for a maximum of six seconds after the ignition has been switched on. The seat belt warning lamp reminds the driver and co-driver to fasten their seat belts.</p> <ul style="list-style-type: none"> ► Fasten your seat belt (→ page 27).
 <p>Seat belt warning lamp</p>	<p>*The red warning lamp for the seat belt lights up after the engine starts as soon as the driver's or co-driver's door has been closed. The driver's or front passenger's seat belt is not fastened.</p> <ul style="list-style-type: none"> ► Fasten your seat belt (→ page 27). The warning lamp will go out. <p>In vehicles with the occupant classification system (OCS), there are objects on the co-driver's seat.</p> <ul style="list-style-type: none"> ► Take the objects off the co-driver's seat and stow them in a well-secured place. The warning lamp will go out.
 <p>Seat belt warning lamp</p>	<p>*The red seat belt warning lamp flashes and an intermittent warning tone sounds. The driver's or front passenger's seat belt is not fastened. You are driving at a speed greater than 15 mph (25 km/h) or have briefly exceeded 15 mph (25 km/h).</p> <ul style="list-style-type: none"> ► Fasten your seat belt (→ page 27). The warning lamp and the intermittent warning tone will go out. <p>In vehicles with automatic co-driver airbag shutoff, there are objects on the co-driver's seat. You are driving at a speed greater than 15 mph (25 km/h) or have briefly exceeded 15 mph (25 km/h).</p> <ul style="list-style-type: none"> ► Take the objects off the front passenger seat and stow them in a well-secured place. The warning lamp and the intermittent warning tone will go out.

Driving systems



Warning/indicator lamp	Possible causes/consequences and ► Solutions
 <p>Warning lamp for distance warning function</p>	<p>*The red distance warning lamp lights up while the vehicle is in motion. The distance to the vehicle in front is too small for the selected speed.</p> <ul style="list-style-type: none"> ► Increase the distance to the vehicle in front.
 <p>Warning lamp for distance warning function</p>	<p>*The red distance warning lamp lights up while the vehicle is in motion. A warning tone also sounds. You are approaching a vehicle or a stationary obstacle on your anticipated route at excessive speed.</p> <ul style="list-style-type: none"> ► Be ready to apply the brakes immediately. ► Pay careful attention to the traffic situation. If necessary, apply the brakes or avoid an obstacle. <p>You can find further information about the distance warning function in "Active Brake Assist" (→ page 113).</p>

Vehicle

Warning/indicator lamp	Possible causes/consequences and ► Solutions
 <p>Power steering system warning lamp</p>	<p>*The red power steering system warning lamp is on while the engine is running. A warning tone also sounds. The power assistance for the steering may be malfunctioning. You may need to use more force to steer.</p> <ul style="list-style-type: none"> ► Carefully drive on to a qualified specialist workshop and have the steering checked immediately.
 <p>Door indicator lamp</p>	<p>*The yellow "door open" indicator lamp is lit. A door is not fully closed.</p> <ul style="list-style-type: none"> ► Close all the doors.

Engine

Warning/indicator lamp	Possible causes/consequences and ► Solutions
 <p>Check Engine warning lamp</p>	<p>*The yellow Check Engine warning lamp is on while the engine is running.</p> <p>There may be a malfunction in the following vehicle systems:</p> <ul style="list-style-type: none"> • Engine management • Transmission management • Injection • Exhaust system

Warning/indicator lamp	Possible causes/consequences and ► Solutions
	<ul style="list-style-type: none"> • Ignition system (in vehicles with a gasoline engine) • Fuel system <p>This can cause the emissions limit values to be exceeded and the engine to run in emergency mode.</p> <p>► Have the vehicle checked immediately at a qualified specialist workshop.</p>
 <p>Fuel reserve warning lamp</p>	<p>*The yellow fuel reserve warning lamp is on while the engine is running. The fuel supply has dropped into the reserve range.</p> <p>► Refuel the vehicle.</p>
 <p>Coolant warning lamp</p>	<p>*</p> <p>In vehicles without steering-wheel buttons, the coolant temperature display is at the start of the bar display (→ page 142).</p> <p>In vehicles with steering-wheel buttons, the coolant temperature display on the instrument cluster is at the start of the scale.</p> <p>The temperature sensor for the coolant temperature display is defective.</p> <p>The coolant temperature is no longer being monitored. If the coolant is too hot, the engine may be damaged.</p> <p>► Stop immediately in accordance with the traffic conditions and switch off the engine. Do not continue driving.</p> <p>► Secure the vehicle against rolling away.</p> <p>► Consult a qualified specialist workshop.</p>
 <p>Coolant warning lamp</p>	<p>*The red coolant warning lamp is on while the engine is running. The coolant level is too low.</p> <p>If the coolant level is correct, the air supply to the radiator may be impaired or the radiator's electric fan may be faulty.</p> <p>The coolant is too hot and the engine is not being adequately cooled.</p> <p>► Pay attention to the display messages.</p> <p>► Stop immediately in accordance with the traffic conditions and switch off the engine.</p> <p>► Secure the vehicle against rolling away.</p> <p>► Exit the vehicle and keep a safe distance from it until the engine has cooled down.</p> <p>► Check the coolant level and add coolant, complying with the instructions (→ page 180).</p> <p>► If the coolant has to be topped up frequently, have the engine cooling system checked at a qualified specialist workshop.</p> <p>► Ensure that the air supply to the radiator is not impaired, e.g. by a plastic bag that has been blown onto the grille.</p> <p>► Check the coolant temperature:</p>

Warning/indicator lamp	Possible causes/consequences and ► Solutions
	<ul style="list-style-type: none"> • In vehicles without steering-wheel buttons – via the display on the on-board computer • In vehicles with steering-wheel buttons – via the analog display on the instrument cluster <p>► Do not restart the engine until the coolant temperature is below the specified maximum value. If you do, the engine may be damaged.</p> <p>► Drive on to the nearest qualified specialist workshop. Avoid high engine loads, e.g. driving on hilly roads or stop-and-go driving.</p> <p>During normal driving and if the coolant level is correct, the coolant temperature display is permitted to rise to letter H or the red mark.</p>
 <p>Coolant warning lamp</p>	<p>*The red coolant warning lamp is on while the engine is running. A warning tone also sounds. The coolant temperature has exceeded the maximum value specified below. The air supply to the radiator may be impaired or the coolant level may be too low.</p> <p>The engine has not been sufficiently cooled and may be damaged.</p> <div style="border: 1px solid gray; padding: 5px; margin: 10px 0;"> <p>▲ WARNING Risk of burns when opening the hood</p> <p>If you open the hood when the engine has overheated or when there is a fire in the engine compartment, the following situations may occur:</p> <ul style="list-style-type: none"> • You could come into contact with hot gases. • You could come into contact with other hot, escaping operating fluids. <p>► Before opening the hood, allow the overheated engine to cool down.</p> <p>► In the event of a fire in the engine compartment, keep the hood closed and call the fire service.</p> </div> <ul style="list-style-type: none"> ► Pay attention to the display messages. ► Stop immediately in accordance with the traffic conditions and switch off the engine. ► Secure the vehicle against rolling away. ► Exit the vehicle and keep a safe distance from it until the engine has cooled down. ► Check the coolant level and add coolant, complying with the instructions (→ page 180). ► If the coolant has to be topped up frequently, have the engine cooling system checked at a qualified specialist workshop. ► Ensure that the air supply to the radiator is not impaired, e.g. by a plastic bag that has been blown onto the grille. ► Check the coolant temperature:

Warning/indicator lamp	Possible causes/consequences and ► Solutions
	<ul style="list-style-type: none"> • In vehicles without steering wheel buttons – via the display on the on-board computer . • In vehicles with steering wheel buttons – via the analog display on the instrument cluster <p>► If the coolant temperature is below the maximum value specified below, you can continue driving to the nearest qualified specialist workshop.</p> <p>► Avoid high engine loads, e.g. driving on hilly roads or stop-and-go driving.</p> <p>During normal driving and if the coolant level is correct, the coolant temperature display is permitted to rise to letter H or the red mark.</p>

Tires

Warning/indicator lamp	Possible causes/consequences and ► Solutions
 <p>Tire pressure monitoring system warning lamp</p>	<p>*The yellow tire pressure monitoring system warning lamp (pressure loss/malfunction) is on. The tire pressure monitoring system has detected a loss of pressure in at least one tire.</p> <div style="border: 1px solid gray; padding: 5px; margin: 5px 0;"> <p>⚠ WARNING Risk of an accident due to insufficient tire pressure</p> <ul style="list-style-type: none"> • The tires can burst. • The tires can wear excessively and/or unevenly. • The driving characteristics as well as the steering and braking may be greatly impaired. <p>You could then lose control of the vehicle.</p> <ul style="list-style-type: none"> ► Observe the recommended tire pressures. ► Adjust the tire pressure if necessary. </div> <p>► Stop the vehicle without steering or braking suddenly. Pay attention to the traffic conditions.</p> <p>► Secure the vehicle against rolling away.</p> <p>► Pay attention to the display messages.</p> <p>► Check the tires and, if necessary, replace the wheel (→ page 218).</p> <p>► Check the tire pressure .</p> <p>In vehicles with steering-wheel buttons, you can check the tire pressure electronically (→ page 209).</p> <p>► Correct the tire pressure as necessary.</p>

Warning/indicator lamp	Possible causes/consequences and ► Solutions
<div data-bbox="194 288 346 369" data-label="Image"> </div> <p data-bbox="185 374 413 422">Tire pressure monitoring system warning lamp</p>	<p data-bbox="455 283 1080 385">*The yellow tire pressure monitoring system warning lamp (pressure loss/malfunction) flashes for approximately one minute and then remains lit. The tire pressure monitoring system is malfunctioning.</p> <div data-bbox="465 401 1102 462" data-label="Text" style="background-color: #f0f0f0; padding: 5px;"> <p data-bbox="475 408 1067 462">▲ WARNING There is a risk of an accident if the tire pressure monitoring system is malfunctioning</p> </div> <div data-bbox="475 473 1084 580" data-label="Text" style="padding: 5px;"> <p data-bbox="475 473 1047 523">The tire pressure monitoring system cannot issue a warning if there is pressure loss in one or more of the tires.</p> <p data-bbox="475 530 1084 580">Tires with insufficient tire pressure may impair the driving characteristics as well as steering and braking.</p> </div> <div data-bbox="475 587 1073 641" data-label="List-Group" style="padding: 5px;"> <ul style="list-style-type: none"> <li data-bbox="475 587 1073 641">► Have the tire pressure monitoring system checked at a qualified specialist workshop. </div> <div data-bbox="465 664 850 722" data-label="List-Group" style="padding: 5px;"> <ul style="list-style-type: none"> <li data-bbox="465 664 850 691">► Pay attention to the display messages. <li data-bbox="465 697 850 722">► Visit a qualified specialist workshop. </div>

- 1, 2, 3 ...
- 3-zone automatic climate control (control panel)**..... 91
- 12 V socket**
see Socket (12 V)
- A**
- ABS (Anti-lock Braking System)**..... 111
- Acceleration**
see Using kickdown
- Active Brake Assist**
Function/notes..... 113
Setting..... 115
- Active Distance Assist DISTRONIC**
Calling up a speed..... 117, 119
Displays..... 120
Function..... 116
Increasing/decreasing speed..... 117, 119
Requirements..... 117, 119
Steering wheel buttons..... 117, 119
Storing a speed..... 117, 119
Switching off/deactivating..... 117, 119
Switching on/activating..... 117, 119
System limitations..... 116
- Active Parking Assist**
Exiting a parking space..... 127
Function..... 125
Parking..... 126
System limitations..... 125
- Adaptive**
see Lane Keeping Assist
- Adaptive cruise control**
see Active Distance Assist DISTRONIC
- Adaptive Highbeam Assist**
Function..... 79
Switching on/off..... 80
- Add-on equipment**..... 14
- Add-on equipment guidelines**..... 14
- Additional turn signal light**
Replacing light sources..... 83
- Additive**
Engine oil..... 228
- Additives**
Fuel..... 228
- Additives (engine oil)**
see Additive
- Additives (fuel)**
see Fuel
- After-sales service**
see ASSYST PLUS service interval display
- Air recirculation button**
Convenience opening/closing..... 95
- Airbag**
Activation..... 24
Front airbag (driver, co-driver)..... 28
Installation locations..... 28
Overview..... 28
PASSENGER AIR BAG indicator lamp.... 31
Protection impaired..... 30
Protection provided..... 29
Side airbag..... 28
Window curtain airbag..... 28
- Alarm system**
see ATA (Anti-Theft Alarm system)
- Alertness assistant**
see ATTENTION ASSIST
- Android Auto settings (multimedia system)**..... 153
- Animals**
Pets in the vehicle..... 41
- Anti-lock braking system**
see ABS (Anti-lock Braking System)
- Anti-skid chains**
see Snow chains
- Anti-theft Alarm system**
see ATA (Anti-Theft Alarm system)
- Anti-theft protection**
Immobilizer..... 59
- Anti-theft protection**
see ATA (Anti-Theft Alarm system)
- Apple CarPlay® settings (multimedia system)**..... 153
- Ashtrays**
In the windshield stowage compartment..... 76
- Assistance Systems**
see Driving safety system
- ASSYST**
see ASSYST PLUS service interval display
- ASSYST PLUS service interval display**
Displaying the service due date (vehicle with steering wheel buttons)..... 175
Displaying the service due date (vehicle without steering wheel buttons)..... 175
Function/notes..... 175

Non-operational times with the battery disconnected.....	176
Regular maintenance work.....	176
Special service requirements.....	176
ATA (Anti-Theft Alarm system)	
Activating and deactivating the interior motion sensor.....	61
Function.....	59
Interior motion sensor function.....	60
Stopping the alarm.....	60
Switching the tow-away alarm on and off.....	60
Tow-away alarm function.....	60
Attachments	14
ATTENTION ASSIST	
Function.....	127
Switching on/off (vehicles with steering-wheel buttons).....	128
Switching on/off (vehicles without steering-wheel buttons).....	128
System limitations.....	127
Audio system (on-board computer)	147
Authorized workshop	
see Qualified specialist workshop	
Automatic distance control	
see Active Distance Assist DISTRONIC	
Automatic driving lights	77
Automatic front passenger front air-bag shutoff	
Function of the automatic front passenger front airbag shutoff.....	30
PASSENGER AIR BAG indicator lamp....	31
Automatic front passenger front air-bag shutoff	
see Automatic front passenger front airbag shutoff	
Automatic measures after an accident	33
Automatic transmission	
DIRECT SELECT lever.....	104
Engaging drive position.....	105
Engaging neutral.....	105
Engaging reverse gear.....	105
Kickdown.....	106
Restricting the shift range.....	106
Selecting park position.....	105
Transmission position display.....	104
Transmission positions.....	104
Axle load	226

B

Back support	
see Lumbar support (4-way)	
Backing up warning device	
Notes.....	121
BAS (Brake Assist System)	111
Battery	
Care.....	191
Charging.....	191
Charging a vehicle battery.....	191
Connecting and installing the auxiliary battery.....	195
Connecting and installing the starter battery.....	195
Disconnecting and removing the auxiliary battery.....	194
Disconnecting and removing the starter battery.....	194
Jump-starting (vehicle).....	191
Key.....	43
Notes (vehicle).....	189
Belt	
see Seat belt	
Belt warning	
see Seat belt	
Blind Spot Assist	
Function.....	129
Switching on/off.....	129
System limitations.....	129
Bluetooth® audio	
Information.....	163
Bluetooth® settings (multimedia system)	153
Bottle holder	75
Brake	
ABS (Anti-lock Braking System).....	111
Activating/deactivating the HOLD function.....	121
Active Brake Assist.....	113
BAS (Brake Assist System).....	111
Braking with parking brake:.....	100
Breaking-in notes.....	97
Downhill gradient.....	100
Driving notes.....	98, 100
EBD (electronic brake force distribution).....	113
Heavy and light loads.....	100
HOLD function.....	121
New brake discs and brake pads/linings.....	100

- New/replaced brake disks and brakepads..... 97
 - Restricted braking effect (salt-treated roads)..... 100
 - Wet road surfaces..... 100
 - Brake Assist System**
see BAS (Brake Assist System)
 - Brake Assistance**
see BAS (Brake Assist System)
 - Brake fluid**
Notes..... 229
 - Brake force distribution**
EBD (electronic brake force distribution)..... 113
 - Brakes**
Post-collision brake..... 33
 - Breakdown**
Changing a wheel..... 218
Recovering the vehicle..... 198
Roadside Assistance..... 15
Tow starting..... 200
Towing away (both axles on the ground)..... 198
Towing away (raised front or rear axle)..... 199
Transporting the vehicle..... 199
Vehicle stuck..... 198
 - Breakdown**
see Flat tire
 - Breaking-in notes**..... 97
 - Buttons on the steering wheel**..... 9
- C**
- Camera**
see Rear view camera
 - Car wash**
see Care
 - Car wash (care)**..... 182
 - Care**
Automatic car wash..... 182
Carpet..... 185
Display..... 185
Exterior lighting..... 184
Headliner..... 185
Matte finish..... 184
Paint..... 184
Plastic trim..... 185
Power washer..... 183
Real wood/trim elements..... 185
Rear view camera..... 184
Seat belt..... 185
 - Seat cover..... 185
 - Sensors..... 184
 - Tailpipes..... 184
 - Trailer hitch..... 184
 - Washing by hand..... 183
 - Wheels/rims..... 184
 - Windows..... 184
 - Wiper blades..... 184
 - Cargo compartment and rear interior lighting**
Replacing light sources..... 84
 - Cargo tie-down points**
Information..... 234
Overview..... 169
 - Carpet (care)**..... 185
 - Carrier systems**
Notes..... 173
 - Center console**
Top (overview)..... 10
 - Changing a bulb**
see Changing bulbs
 - Changing a wheel**
Lowering the vehicle..... 221
Preparing..... 218
Raising the vehicle..... 219
Removing a wheel..... 220
 - Changing address**..... 16
 - Changing bulbs**
Light bulb types halogen headlamps.... 81
Notes..... 80
 - Changing lamps**
see Changing bulbs
 - Changing owner**..... 16
 - Changing settings on the on-board computer (vehicle with steering-wheel buttons)**..... 148
 - Changing settings on the on-board computer (vehicle without steering-wheel buttons)**..... 143
 - Characteristics of the tire**..... 213
 - Charging**
Battery..... 191
 - Child safety lock**
Hinged windows..... 41
 - Child safety lock (doors)**..... 40
 - Child seat**
Attaching (notes)..... 36
Basic instructions..... 33
Front-passenger seat (notes)..... 39

- LATCH-type (ISOFIX) (installing)..... 37
- Notes on risks and dangers..... 34
- Securing on the front passenger seat... 39
- Securing on the rear seat..... 38
- Top Tether..... 38
- Children**
- Avoiding dangers in the vehicle..... 34
- Basic instructions..... 33
- Special seat belt retractor..... 36
- Cigarette lighter**
- Front center console..... 76
- Cleaning**
- see Care
- Climate control**
- Activating/deactivating..... 91
- Adjusting the air vents..... 95
- Air distribution settings..... 93
- Control panel for 3-zone automatic climate control..... 91
- Control panel for dual-zone automatic climate control..... 90
- Controlling automatically..... 92
- Defrosting the windshield..... 94
- Defrosting windows..... 94
- Filling capacity for PAG oil..... 231
- Refrigerant..... 231
- Refrigerant filling capacity..... 231
- Setting the air distribution..... 93
- Setting the airflow..... 93
- Setting the temperature..... 93
- Switching air-recirculation mode on/off..... 94
- Switching residual heat utilization on/off..... 95
- Switching synchronization function on/off (control panel)..... 94
- Switching the A/C function on/off..... 92
- Switching the rear window defroster on/off..... 95
- Ventilating the vehicle (convenience opening)..... 57
- Cockpit (overview)..... 6**
- Combination switch**
- see High beam
- see High-beam flasher
- see Indicator
- Configuring sound settings (multi-media system)..... 155**
- Connecting Android Auto..... 161**
- Connecting Apple CarPlay®..... 161**
- Convenience closing..... 58**
- Convenience opening..... 57**
- Convenience opening/closing..... 95**
- Conversions..... 14**
- Coolant**
- Checking level..... 180
- Filling capacities..... 230
- Refilling..... 180
- Coolant (engine)**
- Displaying the temperature (vehicle without steering-wheel buttons)... 142
- Notes..... 230
- Copyright**
- License..... 23
- Copyrights**
- Trademarks..... 23
- Crosswind Assist**
- Function/notes..... 112
- Cruise control**
- Calling up a speed..... 115
- Function..... 115
- Lever..... 115
- Requirements..... 115
- Selecting..... 115
- Setting the speed..... 115
- Storing a speed..... 115
- Switching off..... 115
- Switching on..... 115
- System limits..... 115
- Cup holders**
- Cockpit overview..... 75
- Customer Assistance Center (CAC)..... 19**
- Customer Relations Department..... 19**
- D**
- DAB radio..... 163**
- Dashboard lighting**
- see Instrument lighting
- Data protection rights**
- Data storage..... 22
- Data recording (vehicle)..... 20**
- Data storage**
- Data protection rights..... 22
- Daytime running lamp mode**
- see Daytime running lights
- Daytime running lamps**
- Replacing light sources..... 81
- Daytime running lights**
- Switching on/off..... 77

- Dealership**
see Qualified specialist workshop
- DEF**
Journeys abroad..... 99
- Definitions (tires and loading).....** 214
- Defrosting windows.....** 94
- Destination**
Editing intermediate destinations..... 160
- Destination entry**
Adding or removing shortcuts..... 158
Displaying current location information..... 157
Displaying or deleting last destinations..... 157
Notes..... 155
Saving and deleting destinations..... 158
Searching for and entering destinations..... 156
Selecting a POI..... 157
- Diagnostics connection.....** 17
- Dimming the inside rearview mirror.....** 89
- DIRECT SELECT lever**
Engaging drive position..... 105
Engaging neutral..... 105
Engaging park position automatically..... 105
Engaging reverse gear..... 105
Function..... 104
Selecting park position..... 105
Transmission positions..... 104
- Direction indicator**
see Indicator
- Display (care).....** 185
- Display (multimedia system)**
Operating..... 153
- Display (on-board computer).....** 140
- Display message**
Calling up (on-board computer)..... 235
Notes..... 235
- Display settings (multimedia system).....** 154
- Displaying location information.....** 157
- Distance control**
see Active Distance Assist DISTRONIC
- Distance warning function**
see Active Brake Assist
- DISTRONIC**
see Active Distance Assist DISTRONIC
- Door**
Locking (emergency key)..... 46
Unlocking (emergency key)..... 46
- Door control panel.....** 12
- DOT, Tire Identification Number (TIN)..** 212
- Drinking and driving.....** 98
- Driving and drinking.....** 98
- Driving characteristics (unusual).....** 204
- Driving light**
see Automatic driving lights
- Driving notes**
Brake subject to load..... 100
Braking..... 100
Breaking-in notes..... 97
Downhill gradient..... 100
Drinking and driving..... 98
General driving tips..... 98
New brake discs and brake pads/linings..... 100
Parking brake..... 100
Restricted braking effect (salt-treated roads)..... 100
Transport by rail..... 99
Wet road surfaces..... 100
- Driving safety system**
ABS (Anti-lock Braking System)..... 111
BAS (Brake Assist System)..... 111
Cameras..... 110
EBD (electronic brake force distribution)..... 113
ESP® Crosswind Assist..... 112
ESP® trailer stabilization..... 113
Overview..... 110
Radar and ultrasonic sensors..... 110
Responsibility..... 109
- Driving safety system**
see Active Brake Assist
see ESP® (Electronic Stability Program)
- Driving system**
see Active Distance Assist DISTRONIC
see Active Parking Assist
see ATTENTION ASSIST
see Blind Spot Assist
see Cruise control
see Driving safety system
see HOLD function
see Lane Keeping Assist
see PARKTRONIC
see Rear view camera
- Driving tips**
Driving abroad (information)..... 99

- Driving in winter..... 101
 - Driving off-road..... 102
 - Driving on flooded roads..... 101
 - Driving on wet roads..... 101
 - Hydroplaning..... 101
 - Mountainous terrain..... 104
 - Drowsiness detection**
see ATTENTION ASSIST
 - Dual-zone automatic climate control (control panel)**..... 90
- E**
- E 10**..... 228
 - EASY-ENTRY easy entry and exit feature**
 - Folding the EASY-ENTRY section forwards and back (rear bench seat).... 68
 - Using (rear bench seat)..... 68
 - EASY-PACK tailgate**
 - Notes..... 52
 - Opening and closing..... 52
 - EBD (electronic brake force distribution)**..... 113
 - Electric sliding door**
 - Function..... 47
 - Opening with button..... 48
 - Opening/closing from the outside..... 50
 - Opening/closing with the door handle..... 50
 - Opening/closing with the key..... 49, 50
 - Problems..... 51
 - Programming the key..... 49
 - Programming the key button..... 50
 - Resetting..... 50
 - Electronic Stability Program**
see ESP® (Electronic Stability Program)
 - Electronics**..... 225
 - Emergency**
 - First-aid kit (soft sided)..... 187
 - Safety vest..... 187
 - Emergency braking**
 - Manual parking brake..... 109
 - Emergency engine start**..... 200
 - Emergency Tensioning Devices**
 - Activation..... 24
 - Engaging drive position (automatic transmission)**..... 105
 - Engaging neutral (automatic transmission)**..... 105
 - Engaging reverse gear**..... 105
- Engine**
 - Engine number..... 226
 - Parking..... 108
 - Problems..... 108
 - Starting (key)..... 97
 - Starting assistance..... 191
 - Engine electronics (notes)**..... 225
 - Engine number**..... 226
 - Engine oil**
 - Additive..... 228
 - Checking the oil level using the on-board computer..... 178
 - Checking the oil level with a dipstick..... 179
 - Filling capacity..... 229
 - Refilling..... 179
 - Engine output**
 - Notes on changes..... 17
 - Environmental protection**
 - Notes..... 13
 - ESC (Electronic Stability Control)**
see ESP® (Electronic Stability Program)
 - ESP®**
 - Crosswind Assist..... 112
 - Trailer stabilization..... 113
 - ESP® (Electronic Stability Program)**
 - Activating/deactivating (on-board computer without steering wheel buttons)..... 111
 - Function/notes..... 111
 - Switching on/off (button)..... 112
 - Switching on/off (on-board computer with steering wheel buttons)..... 112
 - Exhaust emission monitoring**..... 99
 - Exterior lighting**
 - Care..... 184
 - Exterior lighting**
see Lights
- F**
- Factory settings (vehicle with steering-wheel buttons)**..... 148
 - Factory settings (vehicle without steering-wheel buttons)**..... 143
 - Fatigue detection**
see ATTENTION ASSIST
 - Fault message**
see Display message
 - First-aid kit (soft sided)**..... 187

- Flat tire**
 Changing a wheel..... 218
 Notes..... 189
- Foil covering**
 Radar and ultrasonic sensors..... 110
- Free software**..... 23
- Frequencies**
 Mobile phone..... 225
 Two-way radio..... 225
- Front airbag (driver, co-driver)**..... 28
- Front door**
 Opening (from inside)..... 45
 Unlocking (from inside)..... 45
- Front wheel arch**
 Fender..... 81
 Installing/removing the cover..... 81
- Fuel**
 Additives..... 228
 E10..... 228
 Flexible fuel vehicles..... 228
 Fuel reserve..... 228
 Gasoline..... 228
 Journeys abroad..... 99
 Problems..... 108
 Quality (gasoline)..... 228
 Refueling..... 106
 Sulfur content..... 228
 Tank capacity..... 228
- Fuel consumption**
 Displaying current (vehicle without steering-wheel buttons)..... 142
 Displaying the average (vehicle with steering-wheel buttons)..... 145
 Displaying the average (vehicle without steering-wheel buttons)..... 142
- Fuses**..... 201
- G**
- Gasoline**..... 228
- General operating permit number (EC)**..... 226
- Genuine parts**..... 13
- Glasses compartment**..... 75
- Glove box**
 Opening/closing..... 75
- Gross axle weight rating**..... 226
- H**
- Handbrake (manual)**
 see Manual parking brake
- Handling control system**
 see ESP® (Electronic Stability Program)
- Hazard warning light system**
 Switching on/off..... 78
- Hazardous substances**
 Information..... 16
- Head restraint**
 Adjusting mechanically..... 72
- Head restraints**
 Adjusting the front electrically..... 73
- Headliner (care)**..... 185
- Help call**
 see Mercedes-Benz emergency call system
- High beam**
 Activating/deactivating..... 78
 Adaptive Highbeam Assist..... 79
 Replacing light sources..... 81
- High-beam flasher**..... 78
- Hill start assist**..... 120
- Hinged windows**
 Child safety lock..... 41
- HOLD function**
 Notes..... 121
 Switching on/off..... 121
- Home screen**
 Changing the arrangement of the applications..... 153
- Hydroplaning**..... 101
- I**
- Identification plate**
 Engine..... 226
 Refrigerant..... 231
 Vehicle..... 226
- Ignition key**
 see Key
- Ignition lock**..... 97
- Immobilizer**..... 59
- Indicator**
 Activating/deactivating..... 78
- Indicator lamps**
 see Warning/indicator lamps
- Installations**..... 14
- Instrument cluster**
 Adjusting the lighting..... 141
 Displays..... 136
 Notes..... 136
 Notes on warning/indicator lamps..... 260

- Overview..... 136
 - Warning/indicator lamps overview..... 7, 8
 - Instrument lighting**..... 141
 - Instrument panel**
see Cockpit (overview)
 - Intelligent light system**
Adaptive Highbeam Assist..... 79
 - Interior lighting**
Setting..... 80
 - Interior motion sensor**
Activating and deactivating..... 61
 - Function..... 60
 - Intermediate destination**
Modifying..... 160
- J**
- Journeys abroad**
Notes..... 99
 - Jump-start connection point**..... 191
- K**
- Key**
Battery..... 43
 - Convenience opening..... 95
 - Functions..... 42
 - Key ring attachment..... 43
 - Mechanical key..... 43
 - Overview..... 42
 - Problem..... 44
 - Programming the button for the
electric sliding door..... 50
 - Start the vehicle..... 97
 - Unlocking setting..... 42
 - Key positions**..... 97
- L**
- Labeling (tires)**
see Tire labeling
 - Lane Keeping Assist**
Activating/deactivating..... 130
 - Function..... 129
 - Sensitivity..... 130
 - Language settings (multimedia system)**..... 154
 - Lashing straps**
Securing a load..... 170
 - Last destinations**
Selecting or deleting..... 157
 - LATCH-type (ISOFIX) child seat anchor**
Installing..... 37
 - Light switch (overview)**..... 77
 - Lighting**
Adjusting the instrument lighting..... 141
 - Lighting**
see Lights
 - Lights**
Adaptive Highbeam Assist..... 79
 - Automatic driving lights..... 77
 - Combination switch..... 78
 - Hazard warning light..... 78
 - Headlamp range..... 78
 - High beam..... 78
 - High-beam flasher..... 78
 - Indicator..... 78
 - Light switch..... 77
 - Low beam..... 77
 - Parking lights..... 77
 - Rear fog light..... 77
 - Responsibility with lighting systems..... 77
 - Standing lamps..... 77
 - Limited Warranty (vehicle)**..... 20
 - Limiting speed**..... 99
 - Limiting the opening angle (tailgate)**..... 53
 - Load distribution**..... 167
 - Load index (tire)**..... 213
 - Load protection net**..... 172
 - Load securing**
Cargo tie-down points..... 169
 - Installing and removing tie-down
eyes..... 171
 - Lashing straps..... 170
 - Notes..... 168
 - Load securing aid**
Removing/installing the load protection net..... 172
 - Load-bearing capacity (tire)**..... 213
 - Loading**
Definitions..... 214
 - Loading guidelines**..... 166
 - Low beam**
Replacing light sources..... 81
 - Switching on/off..... 77
 - Lubricant additives**
see Additive
 - Lumbar support (4-way)**..... 65

- M**
- M+S tires**..... 205
- Maintenance**
- Notes..... 175
 - Vehicle..... 15
- Maintenance**
- see ASSYST PLUS service interval display
- Malfunction**
- Restraint system..... 24
- Manual parking brake**
- Applying/releasing..... 109
 - Emergency braking..... 109
- Map**
- Adjusting..... 161
 - Using..... 161
- Matte finish (cleaning instructions)**.... 184
- Maximum gross vehicle weight**..... 226
- Maximum tire load**..... 213
- Maximum tire pressure**..... 213
- Mechanical key**
- Locking door..... 46
 - Removing/inserting..... 43
 - Unlocking door..... 46
- Media mode**
- Connecting USB devices..... 163
 - Overview of the media menu..... 163
 - Starting media playback..... 163
 - Supported format and data storage media..... 162
- Medical aids**..... 19
- Memory function (seat)**..... 65
- Menu overview (on-board computer)**.... 141
- Mercedes me**
- Information..... 150
- Mercedes me connect**
- Breakdown assistance call via the breakdown assistance button..... 151
 - Consenting to data transfer..... 151
 - Information..... 150
 - Making a call via the overhead control panel..... 150
 - Transferred data..... 151
- Mercedes PRO**
- Information..... 150
- Mercedes PRO connect**
- Breakdown assistance call via the breakdown assistance button..... 151
 - Consenting to data transfer..... 151
 - Information..... 150
- Making a call via the overhead control panel..... 150
 - Transferred data..... 151
- Mercedes-Benz emergency call system**
- Automatic emergency call..... 188
 - Information..... 187
 - Information on data transfer..... 189
 - Manual emergency call..... 188
 - Overview..... 187
- Message (multifunction display)**
- see Display message
- Message memory**..... 235
- Mirrors**
- Adjusting the inside rearview mirror.... 89
- Mirrors**
- see Outside mirrors
- Mobile phone**
- Frequencies..... 225
 - Transmission output (maximum)..... 225
- Mobile phone**
- see Mobile phone
 - see Smartphone
- Model series**
- see Vehicle identification plate
- Mounting a load**..... 166
- Multi Purpose Vehicle (MPV)**..... 19
- Multifunction display (on-board computer)**..... 140
- Multimedia system**
- Adjusting the volume..... 163
 - Anti-theft protection..... 152
 - Calling up applications..... 153
 - Calling up functions..... 153
 - Calling up the tool menu..... 155
 - Configuring basic settings..... 153
 - Configuring display settings..... 154
 - Configuring language settings..... 154
 - Configuring navigation settings..... 154
 - Configuring notification settings..... 154
 - Configuring settings for connected devices..... 153
 - Configuring smartphone settings..... 153
 - Configuring sound settings..... 155
 - Functions overview..... 152
 - Operating safety..... 152
 - Operating temperature..... 152
 - Overview of the control panel..... 152
 - Setting smartphone functions..... 161
 - Text messages..... 153

N**Navigation**

- Configuring settings..... 154
- Overview..... 155
- Updating maps..... 165

Navigation

- see Destination entry
- see Route

Notes

- Carrier systems..... 173

Notification settings (multimedia system)

154

O**Occupant safety**

- see Airbag
- see Automatic front passenger front airbag shutoff
- see Automatic measures after an accident
- see Pets in the vehicle
- see Post-collision brake
- see Restraint system
- see Seat belt

Odometer

- Displaying (vehicle without steering-wheel buttons)..... 142

On-board computer

- Menu overview..... 141
- Multifunction display..... 140
- Operation (vehicles with steering-wheel buttons)..... 138
- Operation (vehicles without steering-wheel buttons)..... 137
- Overview (vehicles with steering-wheel buttons)..... 138
- Overview (vehicles without steering-wheel buttons)..... 137

On-board computer (vehicle with steering wheel buttons)

- Displaying the service due date..... 175
- Service menu..... 144
- Telephone menu..... 147

On-board computer (vehicle with steering-wheel buttons)

- Assistance menu..... 144
- Audio menu..... 147
- Digital speedometer..... 145
- Factory settings..... 148
- Navigation menu..... 146
- Selecting the permanent display function..... 148

- Selecting the unit of measurement for distance..... 148
- Setting the display language..... 148
- Setting the sensitivity of the rain sensor..... 148
- Setting the surround lighting..... 148
- Setting the time and date..... 148
- Settings menu..... 148
- Showing the range..... 145
- Status overview of driving systems.... 144
- Trip menu..... 145

On-board computer (vehicle without steering wheel buttons)

- Displaying the service due date..... 175

On-board computer (vehicle without steering-wheel buttons)

- Coolant temperature display..... 142
- Current fuel consumption..... 142
- Factory settings..... 143
- Odometer..... 142
- Recuperation display..... 142
- Selecting the permanent display function..... 143
- Selecting the unit of measurement for distance..... 143
- Setting the display language..... 143
- Setting the sensitivity of the rain sensor..... 143
- Setting the time and date..... 143
- Settings menu..... 143
- Trip computer..... 142
- Trip distance..... 142

On-board diagnostic interface

- see Diagnostics connection

On-board electronics

- Engine electronics..... 225
- Notes..... 225
- Two-way radios..... 225

Open-source software..... 23**Opening and closing the sliding windows..... 58****Opening/closing the hood..... 176****Operating fluids**

- Additives (fuel)..... 228
- Brake fluid..... 229
- Coolant (engine)..... 230
- Engine oil..... 228
- For drive axles and transmissions..... 229
- Fuel (gasoline)..... 228
- Notes..... 227
- Transmission oil..... 229
- Windshield washer fluid..... 231

- Operating Instructions (vehicle equipment)**..... 14
- Operating safety**
 Changes in the engine power output.... 17
 Information..... 16
- Outside mirror**
 Setting options..... 12
- Outside mirrors**
 folding in/out..... 88
 Setting..... 88
- Overhead control panel**
 Adjusting the interior lighting..... 80
 Overview..... 11
- P**
- Paint (cleaning instructions)**..... 184
- Paint code**..... 226
- Park position**
 Engaging..... 105
 Engaging automatically..... 105
- Parking aid**
 see PARKTRONIC
- Parking assistance systems**
 see Active Parking Assist
- Parking brake (manual)**
 see Manual parking brake
- Parking for an extended period**..... 109
- Parking lights**..... 77
- PARKTRONIC**
 Function..... 122
 Switching on/off..... 123
- PASSENGER AIR BAG status display**
 see Automatic front passenger front airbag shutoff
- Permissible gross mass**..... 226
- Permitted towing methods**..... 197
- Pets in the vehicle**..... 41
- Placing a call (smartphone)**..... 161
- Plastic trim (care)**..... 185
- POI**
 Selecting..... 157
- Post-collision brake**..... 33
- Power supply**
 Switching on..... 97
- Power washer (care)**..... 183
- Power windows**
 see Side window
- Q**
- QR code (rescue card)**..... 20
- Qualified specialist workshop**..... 18
- R**
- Radar and ultrasonic sensors**
 Damage..... 110
- Radio**
 Setting a station..... 163
 Setting DAB stations..... 163
 Storing radio stations..... 164
 Switching traffic announcements on/off..... 164
- Rain sensor**
 Setting the sensitivity (vehicle with steering-wheel buttons)..... 148
 Setting the sensitivity (vehicle without steering-wheel buttons)..... 143
- Range**
 Displaying (vehicle with steering-wheel buttons)..... 145
- Real wood (care)**..... 185
- Rear bench seat**
 Folding forwards and backwards..... 70
 Moving..... 69
 Notes..... 66
 Seat/bunk combination..... 70
 Using the entry and exit feature (EASY-ENTRY)..... 68
- Rear compartment and cargo compartment lamps**
 Replacing light sources..... 84
- Rear fog light**..... 77
- Rear seats**
 Notes..... 66
 Seat anchorage..... 66
 Seating variants..... 66
- Rear view camera**
 Care..... 184
 Function..... 123
- Rear window**
 Opening and closing separately..... 53
- Rear window wiper**
 Replacing..... 87
 Switching on/off..... 86
- Rear-end doors**
 Opening and closing (from inside)..... 55
 Opening and closing (from outside)..... 54
 Opening to 180° or 270°..... 56

- Refrigerant (air conditioning)**
Notes..... 231
- Refueling**
Refueling the vehicle..... 106
- Registration**
Vehicle..... 18
- Regulating headlamp range**..... 78
- Replacing a wheel**
Installing a new wheel..... 220
- Replacing bulbs**
Tail lamp types..... 83
Tail lamps..... 83
- Replacing light sources**
Additional turn signal light..... 83
Daytime running lamps..... 81
High beam..... 81
Installing/removing the cover
(front wheel arch)..... 81
Low beam..... 81
Rear compartment and cargo com-
partment lamps..... 84
Standing/parking lamps..... 81
Surround lighting..... 84
Turn signal light..... 81
- Reporting safety defects**..... 19
- Rescue card**..... 20
- Residual heat utilization**
Activating/deactivating..... 95
- Restraint system**
Basic instructions for children..... 33
Function in an accident..... 24
Functionality..... 24
Malfunction..... 24
Protection limited..... 24
Protection provided..... 24
Self-test..... 24
Warning lamps..... 24
- Restricting the shift range**..... 106
- Roadside Assistance (breakdown)**..... 15
- Roll away protection**
see HOLD function
- Roof carrier**
see Roof luggage rack
- Roof luggage rack**..... 234
- Route**
Calculating..... 159
Notes..... 158
Planning with myTrips..... 160
Selecting a detour..... 159
Selecting options..... 159
- Starting and ending..... 158
- S**
- Safety systems**
see Driving safety system
- Safety vest**..... 187
- Satellite radio**
Activating/deactivating TuneStart™... 165
Deleting user data..... 165
Information..... 164
Logging in..... 164
Searching unsubscribed channels..... 165
Selecting a category..... 165
Using playback mode..... 165
- Seat belt**
Adjusting the height..... 27
Care..... 185
Fastening..... 27
Protection impaired..... 26
Protection provided..... 25
Releasing..... 28
Warning lamps..... 28
- Seat cover (care)**..... 185
- Seat/bunk combination**
Notes..... 70
- Seats**
4-way lumbar support..... 65
Adjusting (electrically)..... 64
Adjusting (manually)..... 62
Adjusting armrests..... 66
Adjusting the head restraints
mechanically..... 72
correct driver's seat position..... 62
Operating the memory function..... 65
- Securing luggage**..... 166
- Selector lever**
see DIRECT SELECT lever
- Self-test**
Automatic front passenger front
airbag shutoff..... 31
- Sensors (care)**..... 184
- Service**
see ASSYST PLUS service interval display
- Service center**
see Qualified specialist workshop
- Service products**
Refrigerant (air conditioning)..... 231
- Setting the airflow**..... 93
- Setting the date (vehicle with steer-
ing-wheel buttons)**..... 148

- Setting the date (vehicle without steering-wheel buttons)**..... 143
- Setting the language (vehicle with steering-wheel buttons)**..... 148
- Setting the language (vehicle without steering-wheel buttons)**..... 143
- Setting the speed**
see Cruise control
- Setting the temperature**..... 93
- Setting the time (vehicle with steering-wheel buttons)**..... 148
- Setting the time (vehicle without steering-wheel buttons)**..... 143
- Setting units on the on-board computer (vehicle with steering-wheel buttons)**..... 148
- Setting units on the on-board computer (vehicle without steering-wheel buttons)**..... 143
- Shortcuts (destination entry)**..... 158
- Showing traffic information**..... 160
- Side airbag**..... 28
- Side window**
Closing..... 56
Closing (all)..... 56
Closing using the key..... 58
Convenience closing..... 58
Convenience opening..... 57
Opening..... 56
Opening (all)..... 56
Opening with the key..... 57
Problems..... 59
- Side windows**
Resetting..... 58
- Size designation (tire)**..... 213
- Sliding door**
B-pillar door sill (button)..... 48
Center console (button)..... 48
Child safety lock..... 40
Closing (from the inside)..... 47
Closing (from the outside)..... 47
Opening (from the inside)..... 47
Opening (from the outside)..... 47
- Smartphone**
Configuring settings..... 153
Pairing..... 161
Placing a call..... 161
Setting functions..... 161
- Snow chains**..... 205
- Socket (12 V)**
Front center console..... 76
- Spare wheel**
Installing/removing..... 223
Notes..... 222
- Special seat belt retractor**..... 36
- Specialist workshop**..... 18
- Speed rating (tire)**..... 213
- Speedometer**..... 136
- Standard**
see Lane Keeping Assist
- Standard rear bench seat**
Removing/installing..... 72
- Standing lamps**..... 77
- Standing/parking lamps**
Replacing light sources..... 81
- Starting assistance**
see Jump-start connection point
- Starting-off aid**
see Hill start assist
- Steering wheel buttons**..... 9
- Stopping the alarm (ATA)**..... 60
- Storage compartment in the rear compartment**..... 202
- Storage compartment in the seat base**..... 201
- Storage space in the cargo compartment**..... 203
- Stowage space**
Glasses compartment..... 75
- Sulfur content**..... 228
- Summer tires**..... 204
- Surround lighting**
Setting (vehicle with steering-wheel buttons)..... 148
- Switch-off delay time**
Setting (vehicle with steering-wheel buttons)..... 148
- Switching air-recirculation mode on/off**..... 94
- Switching on the ignition**..... 97
- Switching seat heating on/off**..... 74
- Switching synchronization function on/off (control panel)**..... 94
- Switching the A/C function on/off**..... 92

- Switching the rear window defroster on/off**..... 95
- T**
- Tail lamps (replacing bulbs)**..... 83
- Tailgate**
- EASY-PACK..... 52
 - Limiting the opening angle..... 53
 - Opening and closing..... 51
 - Opening in an emergency..... 51
 - Programming the key button..... 54
 - Resetting..... 53
 - Separately opening rear window..... 53
- Tailpipes (care)**..... 184
- Tank capacity**
- Fuel..... 228
 - Reserve (fuel)..... 228
- Technical data**
- Information..... 225
 - Notes (trailer hitch)..... 233
 - Tire pressure monitor..... 210
 - Transmission oil..... 229
 - Vehicle identification plate..... 226
- Telephone**
- Operation via the on-board computer (vehicle with steering wheel buttons)..... 147
- Temperature**
- Coolant (display in the on-board computer)..... 142
- Temperature grade**..... 211
- Tie-down eyes**..... 171
- Tire Identification Number (TIN)**..... 212
- Tire labeling**
- Characteristics..... 213
 - DOT, Tire Identification Number (TIN)..... 212
 - Load index..... 213
 - Load-bearing capacity..... 213
 - Maximum tire load..... 213
 - Maximum tire pressure..... 213
 - Overview..... 211
 - Size designation..... 213
 - Speed rating..... 213
 - Temperature grade..... 211
 - Tire quality grades..... 211
 - Traction grade..... 211
 - Tread wear grade..... 211
- Tire load (maximum)**..... 213
- Tire pressure**
- Checking (tire pressure monitoring system)..... 209
 - Maximum..... 213
 - Notes..... 206
 - Restarting the tire pressure monitor.. 209
 - Tire pressure monitoring system (function)..... 209
 - Tire pressure table..... 207
- Tire pressure monitor**
- Checking the tire pressure..... 209
 - Checking the tire temperature..... 209
 - Function..... 209
 - Restarting..... 209
 - Technical data..... 210
- Tire pressure table**..... 207
- Tire quality grades**..... 211
- Tire temperature**
- Checking (tire pressure monitoring system)..... 209
 - Tire pressure monitoring system (function)..... 209
- Tire tread**..... 204
- Tires**
- Characteristics..... 213
 - Checking..... 204
 - Checking the tire pressure (tire pressure monitoring system)..... 209
 - Definitions..... 214
 - Direction of rotation..... 218
 - DOT, Tire Identification Number (TIN)..... 212
 - Flat tire..... 189
 - Installing..... 220
 - Load index..... 213
 - Load-bearing capacity..... 213
 - M+S tires..... 205
 - Maximum tire load..... 213
 - Maximum tire pressure..... 213
 - Noise..... 204
 - Notes on installing..... 216
 - Overview of tire labeling..... 211
 - Removing..... 220
 - Replacing..... 216, 218
 - Restarting the tire pressure monitor.. 209
 - Selecting..... 216
 - Size designation..... 213
 - Snow chains..... 205
 - Speed rating..... 213
 - Storing..... 218
 - Summer tires..... 204
 - Temperature grade..... 211
 - Tire pressure (notes)..... 206

- Tire pressure monitoring system (function)..... 209
- Tire pressure table..... 207
- Tire quality grades..... 211
- Traction grade..... 211
- Tread wear grade..... 211
- Unusual driving characteristics..... 204
- Wheel size categories..... 218
- Wheel/tire combinations..... 221
- Tires**
 - see Wheels
- Tool**
 - see Storage compartment in the rear compartment
 - see Storage compartment in the seat base
 - see Storage space in the cargo compartment
 - see Vehicle tool kit
- Top Tether**..... 38
- Topping up the windshield washer system**..... 181
- Touchscreen (media display)**
 - Operating..... 153
- Tow starting**..... 200
- Tow-away alarm**
 - Arming and disarming..... 60
 - Function..... 60
- Towing away**
 - Both axles on the ground..... 198
 - Raised front or rear axle..... 199
- Towing eye**
 - Installing/removing..... 200
 - Storage location..... 200
- Towing methods**..... 197
- Traction grade**..... 211
- Traffic announcements**
 - Switching on/off..... 164
- Trailer hitch**
 - Care..... 184
 - General notes..... 233
 - Information..... 133
 - Information about trailer operation..... 131
 - Permissible trailer loads and trailer drawbar noseweights..... 134
 - Power supply..... 135
 - Socket..... 132
- Trailer loads**..... 233
- Trailer operation**
 - Coupling/Decoupling the trailer..... 132
 - Gross axle weight rating..... 226
 - Information..... 133
 - Notes..... 131
 - Permissible trailer loads and trailer drawbar noseweights..... 134
 - Power supply..... 135
 - Socket..... 132
 - Trailer loads..... 233
- Trailer stabilization**..... 113
- Transmission oil**
 - General notes..... 229
 - Quality..... 229
- Transmission position display**..... 104
- Transport by rail**..... 99
- Transporting (vehicle breakdown)**..... 199
- Tread wear grade**..... 211
- Trim element (care)**..... 185
- Trip computer**
 - Resetting (vehicle with steering-wheel buttons)..... 145
 - Resetting (vehicle without steering-wheel buttons)..... 142
- Trip distance**
 - Resetting (vehicle without steering-wheel buttons)..... 142
- TuneMix™**
 - Creating a list..... 165
- Turn signal light**
 - Additional turn signal lamp (replacing bulbs)..... 83
 - Replacing light sources..... 81
- Two-way radio telephone**
 - see Mobile phone
- Two-way radios**
 - Frequencies..... 225
 - Installation notes..... 225
 - Transmission output (maximum)..... 225

U

- Unlocking setting**..... 42
- Unlocking/locking**
 - Switching automatic locking feature on/off..... 46
 - Unlocking and opening front doors from inside..... 45
- Updating software (multimedia system)**..... 165
- Using a sun visor**..... 89
- Using kickdown**..... 106

Using the stowage net on the seat

backrest..... 75

V**Vehicle**

Correct use..... 18
 Data recording..... 20
 Diagnostics connection..... 17
 Equipment..... 14
 Limited Warranty..... 20
 Locking (automatic)..... 46
 Locking/unlocking (emergency key).... 46
 Lowering..... 221
 Maintenance..... 15
 Medical aids..... 19
 Notifying problems..... 19
 Parking..... 108
 Parking for an extended period..... 109
 QR code rescue card..... 20
 Qualified specialist workshop..... 18
 Raising..... 219
 Registration..... 18
 Starting (key)..... 97
 Switching on the power supply..... 97
 Unlocking (from inside)..... 45
 Ventilating (convenience opening)..... 57

Vehicle data

Vehicle height..... 232
 Vehicle length..... 232
 Vehicle width..... 232
 Wheelbase..... 232

Vehicle data memory

Electronic control units..... 20
 Service providers..... 22

Vehicle data storage

Event data recorders..... 22

Vehicle dimensions..... 232

Vehicle identification number

see VIN

Vehicle identification plate

EC general operating permit number..... 226
 Gross axle weight rating..... 226
 Maximum permissible gross vehicle weight..... 226
 Paint code..... 226
 VIN..... 226

Vehicle interior

Replacing light sources..... 84

Vehicle key

see Key

Vehicle maintenance

see ASSYST PLUS service interval display

Vehicle operation

Outside the USA or Canada..... 15

Vehicle tool kit

In the seat base..... 201
 Storage compartment in the rear compartment..... 201
 Storage location..... 201
 Towing eye..... 200

VIN

Identification plate..... 226
 Reading out..... 226
 Seat..... 226
 Windshield..... 226













Vision

Defrosting windows..... 94

W**Warning system**

see ATA (Anti-Theft Alarm system)

Warning/indicator lamp

 ABS warning lamp..... 261, 262
 Brake system warning lamp
 261, 262
 Check Engine warning lamp..... 265
 Coolant warning lamp..... 266, 267
 Door indicator lamp..... 265
 ESP® OFF warning lamp..... 263
 ESP® warning lamp..... 262, 263
 Fuel reserve warning lamp..... 266
 Power steering system warning lamp..... 265
 Restraint system warning lamp..... 261
 Seat belt warning lamp..... 264
 Tire pressure monitoring system warning lamp..... 268, 269
 Warning lamp for distance warning function..... 265

Warning/indicator lamps

Notes..... 260
 Overview..... 7, 8
 PASSENGER AIR BAG..... 31

Warranty..... 20

Warranty terms and conditions..... 15

- Washer fluid**
see Windshield washer fluid
- Washing by hand (care)**..... 183
- Washing the engine**..... 183
- Wheel rotation**..... 217
- Wheels**
Care..... 184
Characteristics of the tire..... 213
Checking..... 204
Checking the tire pressure (tire pressure monitoring system)..... 209
Definitions..... 214
DOT, Tire Identification Number (TIN)..... 212
Flat tire..... 189
Installing..... 220
Load index..... 213
Load-bearing capacity..... 213
Maximum tire load..... 213
Maximum tire pressure..... 213
Noise..... 204
Notes on installing..... 216
Overview of tire labeling..... 211
Removing..... 220
Replacing..... 216, 218
Restarting the tire pressure monitor.. 209
Rotating..... 217
Selecting..... 216
Size designation..... 213
Snow chains..... 205
Speed rating..... 213
Storing..... 218
Technical data..... 221
Temperature grade..... 211
Tire pressure (notes)..... 206
Tire pressure monitoring system (function)..... 209
Tire pressure table..... 207
Tire quality grades..... 211
Traction grade..... 211
Tread wear grade..... 211
Unusual driving characteristics..... 204
Wheel size categories..... 218
Wheel/tire combinations..... 221
- Wheels (care)**..... 184
- Window curtain airbag**..... 28
- Windows**
see Side window
- Windows (care)**..... 184
- Windshield**
Defrosting..... 94
Replacing the wiper blades..... 86
- Windshield**
see Windshield
- Windshield washer fluid**..... 231
- Windshield wipers**
Replacing the wiper blades..... 86
Switching on/off..... 85
- Winter driving (snow chains)**..... 205
- Winter tires**..... 205
- Wiper blades**
Care..... 184
Replacing..... 86
Replacing (rear window)..... 87
- Workshop**
see Qualified specialist workshop

